

EasyTrax® series

Extremely fast
cable laying
thanks to easy
cable insertion



Trademarks are legally protected for the TSUBAKI KABELSCHLEPP GmbH
as a national or international registration in the following countries:
tsubaki-kabelschlepp.com/trademarks

Subject to change without notice.

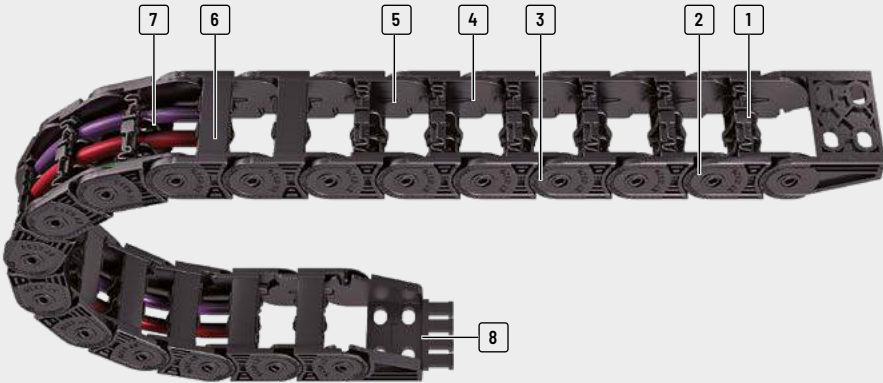

- | | | | |
|--|--|--|--|
| <p>1 Sturdy 2-component design: solid chain body, flexible film hinge</p> <p>2 Plastic chain links</p> | <p>3 Extensive unsupported length</p> <p>4 Inside space is gentle on the cables - no interfering edges</p> | <p>5 Very quiet through integrated noise damping</p> <p>6 Inside or outside openable</p> | <p>7 Dividers for cable separation</p> <p>8 Single-part end connectors with integratable strain relief</p> |
|--|--|--|--|

Features

- | | |
|---|---|
| <ul style="list-style-type: none"> » Very fast cable laying by simply pressing in the cables » Very high fill level through lateral swivelling of the lamella - lamellae do not swivel into the cable space » Each chain link consists of two different materials: <ul style="list-style-type: none"> - Hard chain body made of glass-fibre reinforced material - Lamellae with flexible film hinge made of special elastic plastic | <ul style="list-style-type: none"> » Sturdy cable carrier design » High torsional rigidity » Extensive unsupported length » Very quiet through integrated noise damping |
|---|---|

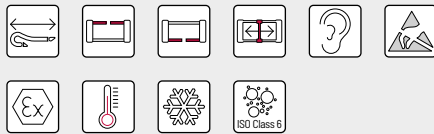

Fast and easy installation of cables



Very high fill level



High side stability



Divider systems for reliable cable separation

Cable carrier

Cable carrier configuration

Configuration guidelines

Materials information

MONO series

QuickTrax® series

UNIFLEX Advanced series

TKP35 series

TKK series

EasyTrax® series

Cable carrier

Cable carrier configuration

Configuration guidelines

Materials information

MONO series

QuickTrax® series

UNIFLEX Advanced series

TKP35 series

TKK series

EasyTrax® series

Cable carrier design

Solid plastic cable carriers: chain links and end connectors made of plastic

Each chain link consists of two different materials:

- » Hard cable carrier body made of glass fiber-reinforced material
- » Flexible lamellae made of elastic plastic

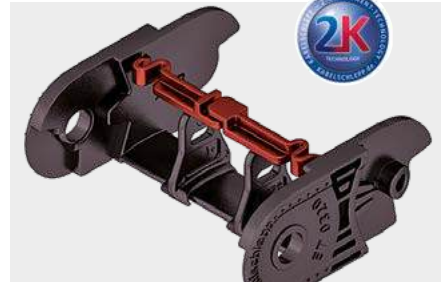

The two-component technology

The two-component technology of the EasyTrax® combines two seemingly incompatible features: **stability and flexibility**.

Cable carriers need to be extremely sturdy, with extensive unsupported length. At the same time, cables need to be inserted easily for fast cable laying. The EasyTrax® meets

these requirements thanks to its innovative design and material combination of a hard cable carrier body made from fiber glass reinforced material and lamellae made of elastic plastic.

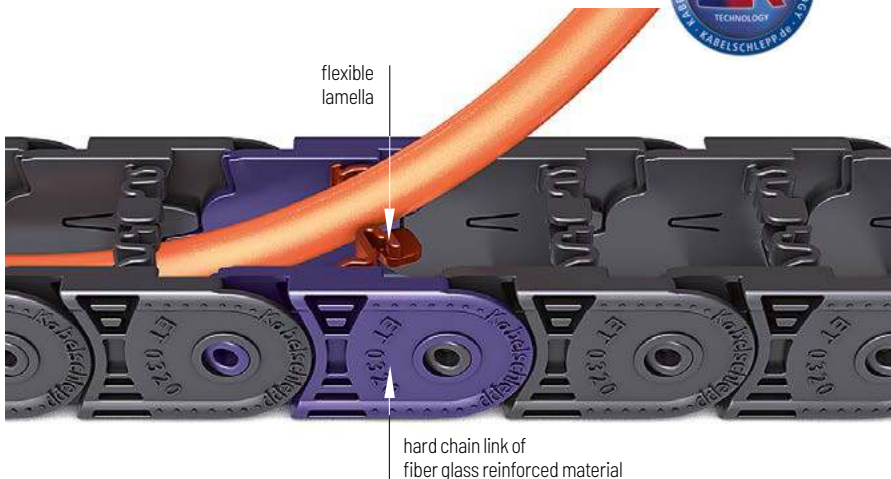
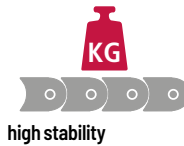
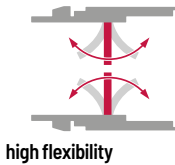

Comparison of dimensions

Manufacturer	h_i [mm]	h_G [mm]	t [mm]	Identical connection hole pattern
ET0320	18	25.5	32	yes
Competitive product	19	25	30.5	yes

Comparison of bending moment

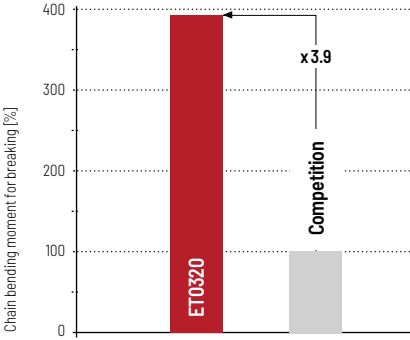

Comparison of bending strength

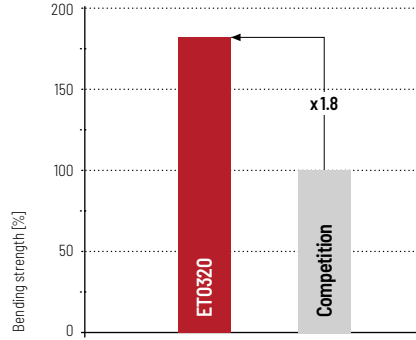

Load diagram

for unsupported length depending on additional load

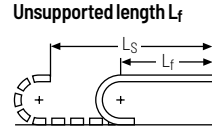
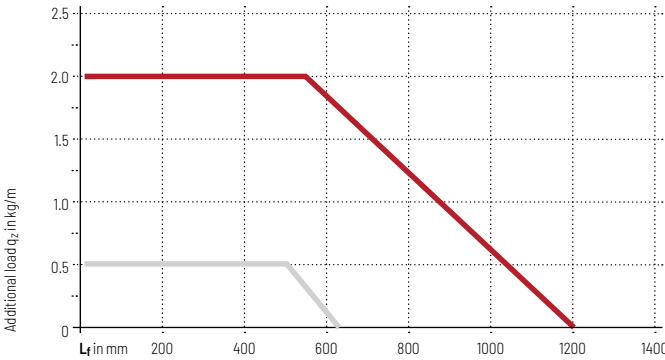

— ET0320
— Competitive product

Advantages over competitive product

- » 4 times bigger additional load compared to competitive product
- » Double unsupported length compared to competitive product
- » Faster cable laying at a higher utilization faktor
- » Low noise operation due to internal damping system
- » High side stability through locking in the stroke system
- » Dividers can be used for cable separation

	Type	Opening variant	Stay variant	h_i	h_G	B_i	B_k	B_i - grid	t	KR	Additional load \leq [kg/m]	Cable- d_{max} [mm]
				[mm]	[mm]	[mm]	[mm]	[mm]	[mm]	[mm]		
Cable carrier												
Cable carrier configuration	ET0115											
Configuration guidelines		040	4.6	8	7	11	-	11.5	10	0.4	3.5	
Materials information	ET0250											
		030	16.5	23	30 - 50	60	-	25	28 - 100	4	13	
		040	16.5	23	30 - 50	60	-	25	28 - 100	4	13	
MONO series	ET0320											
		030	18	25.5	15 - 65	27 - 77	-	32	28 - 125	1.2	14	
		040	18	25.5	15 - 65	27 - 77	-	32	28 - 125	1.2	14	
QuickTrax® series	ET1455											
UNIFLEX Advanced series		030	25	36	25 - 78	94	-	45.5	52 - 200	6	20	
		040	25	36	25 - 78	94	-	45.5	52 - 200	6	20	
TKP35 series												
TKK series												

Unsupported arrangement			Gliding arrangement			Inner Distribution				Movement			Page
Travel length ≤ [m]	$v_{max} \leq [m/s]$	$a_{max} \leq [m/s^2]$	Travel length ≤ [m]	$v_{max} \leq [m/s]$	$a_{max} \leq [m/s^2]$	TS0	TS1	TS2	TS3	vertical hanging or standing	lying on the side	rotating arrangement	
0.68	3	10	-	-	-	-	-	-	-	•	-	-	242
1.6	10	50	60	3	30	•	-	-	-	•	-	•	246
1.6	10	50	-	-	-	•	-	-	-	•	-	•	247
2.90	10	50	80	2.5	25	•	-	-	-	•	-	•	252
2.90	10	50	-	-	-	•	-	-	-	•	-	•	253
4.80	10	50	-	-	-	-	-	-	-	•	-	•	258
4.80	10	50	-	-	-	-	-	-	-	•	-	•	259

Cable carrier

Cable carrier configuration

Configuration guidelines

Materials information

MONO series

QuickTrax® series

UNIFLEX Advanced series

TKP35 series

TKK series

ET0115



Pitch
11.5 mm



Inner height
4.6 mm



Inner width
7 mm



Bending radius
10 mm

Stay variants



Design 040 page 242

Frame with lamellae in the inner radius

- » Weight-optimised plastic frame with particularly high torsional rigidity.
- » Swivelling at any position on one side.
- » **Inside:** swivelling.



TOTALTRAX® complete systems

Benefit from the advantages of the TOTALTRAX® complete system. A complete delivery from one source – with a warranty certificate on request! Learn more at tsubaki-kabelschlepp.com/totaltrax



TRAXLINE® cables for cable carriers

Hi-flex electric cables which were specially developed, optimised and tested for use in cable carriers can be found at tsubaki-kabelschlepp.com/traxline.

Unsupported arrangement

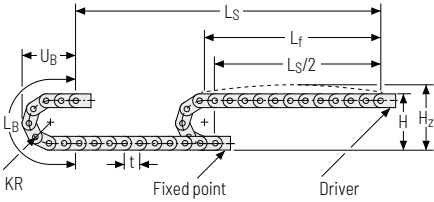

KR [mm]	H [mm]	H _z [mm]	L _B [mm]	U _B [mm]
10	28	38	54.5	25.5

Load diagram for unsupported length depending on the additional load.

Intrinsic cable carrier weight $q_k = 0.044 \text{ kg/m}$ with $B_3 = 7 \text{ mm}$. For other inner widths, the maximum additional load changes.

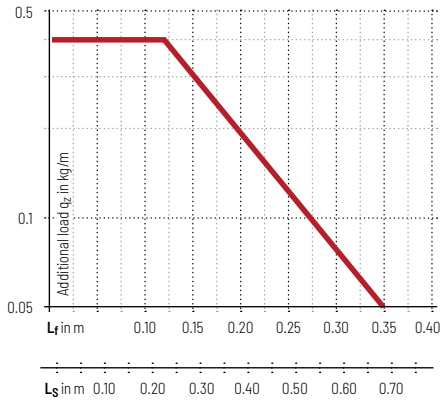

Speed
up to 3 m/s

Acceleration
up to 10 m/s²

Travel length
up to 0.68 m

Additional load
up to 0.4 kg/m

Cable carrier
Cable carrier configuration
Configuration guidelines
Materials information
MONO series
QuickTrax® series
UNIFLEX Advanced series
TKP35 series
TKK series

Additional product information online



Installation instructions, etc.:
Additional info via your smartphone or check online at tsubaki-kabelschlepp.com/downloads



Configure your cable carrier here:
online-engineer.de

Subject to change without notice.

Stay variant 040 – with lamella in the inner radius

- » Weight-optimised plastic frame with particularly high torsional rigidity.
- » Can be swivelled at any position on one side.
- » **Inside:** swivelling.



Stay arrangement on each chain link (**VS: fully-stayed**)



B_i 7 mm

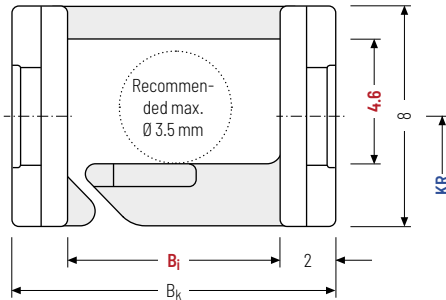

The maximum cable diameter strongly depends on the bending radius and the desired cable type. Please contact us.

Calculating the cable carrier length

Cable carrier length L_k

$$L_k \approx \frac{L_S}{2} + L_B$$

Cable carrier length L_k
rounded to pitch t

h_i [mm]	h_g [mm]	B_i [mm]	B_k [mm]	KR [mm]	q_k [kg/m]
4.6	8	7	$B_i + 4$	10	0.044

Order example



ET0115

Type

040

Stay variant

7

B_i [mm]

10

KR [mm]

1,280

L_k [mm]

VS

Stay arrangement

End connector – plastic

The plastic end connectors can be connected **from above or below**.

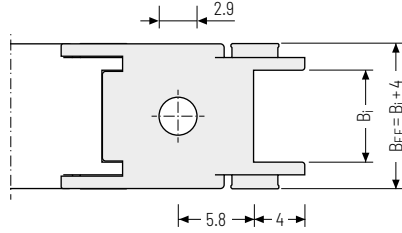
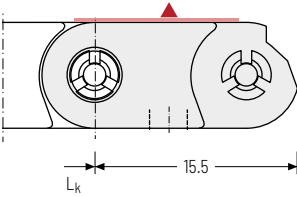

▲ Assembly options

 The end connectors can be swivelled in the KR direction.

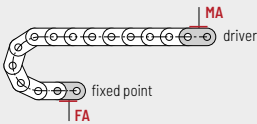

Connection point
F – fixed point
M – driver

Connection type
A – threaded joint outside (standard)

Order example

	End connector	.	F	A
	End connector	.	M	A
	End connector		Connection point	Connection type

Subject to change without notice.

Cable carrier
Cable carrier configuration
Configuration guidelines
Materials information
MONO series
QuickTrax® series
UNIFLEX Advanced series
TKP35 series
TKK series

ET0250



Pitch
25 mm



Inner height
16.5 mm



Inner widths
30 – 50 mm



Bending radii
28 – 100 mm

Stay variants



Design 030 page **246**

Frame with lamellae in the outer radius

- » Weight-optimised plastic frame with particularly high torsional rigidity.
- » Lamellae can be swivelled at any position on one side.
- » **Outside:** swivelling.



Design 040 page **247**

Frame with lamellae in the inner radius

- » Weight-optimised plastic frame with particularly high torsional rigidity.
- » Lamellae can be swivelled at any position on one side.
- » **Inside:** swivelling.



UNIFLEX Advanced

For a non-opening cable carrier with 17.5 mm inner height we recommend the series UNIFLEX Advanced **UA1250 from page 150.**

Unsupported arrangement

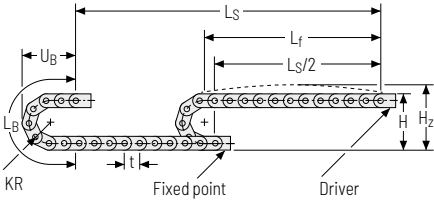



KR [mm]	H [mm]	H _z [mm]	L _B [mm]	U _B [mm]
28	79	104	138	65
38	99	124	169	75
45	113	138	191	82
60	143	168	238	97
75	173	198	286	112
100	223	248	364	137

Load diagram for unsupported length depending on the additional load.

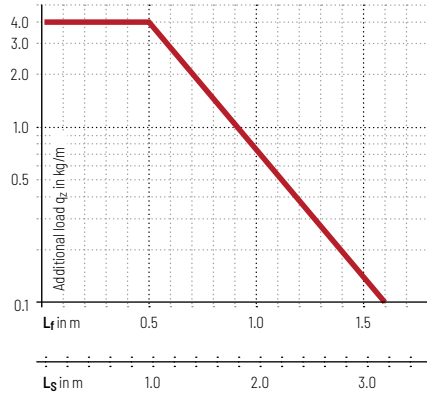



Intrinsic cable carrier weight $q_k = 0.36 \text{ kg/m}$ with $B_3 50 \text{ mm}$. For other inner widths, the maximum additional load changes.

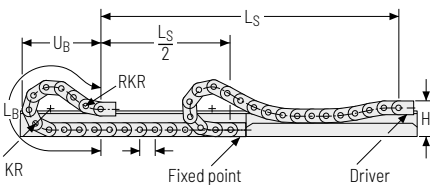

-  **Speed**
up to 10 m/s
-  **Acceleration**
up to 50 m/s^2
-  **Travel length**
up to 1.6 m
-  **Additional load**
up to 4 kg/m

Gliding arrangement



-  **Speed**
up to 3 m/s
-  **Acceleration**
up to 30 m/s^2
-  **Travel length**
up to 60 m
-  **Additional load**
up to 4 kg/m

 The gliding cable carrier must be guided in a channel. See p. 846.

Only design 030 can be used for a gliding arrangement.

Cable carrier
Cable carrier configuration
Configuration guidelines
Materials information
MONO series
QuickTrax® series
UNIFLEX Advanced series
TKP35 series
TKK series

Stay variant 030 – with lamellae in the outer radius

- » Weight-optimised plastic frame with particularly high torsional rigidity.
- » Lamellae can be swivelled at any position on one side
- » **Outside:** swivelling.



Stay arrangement on each chain link (**VS: fully-stayed**)



B_i 30 – 50 mm

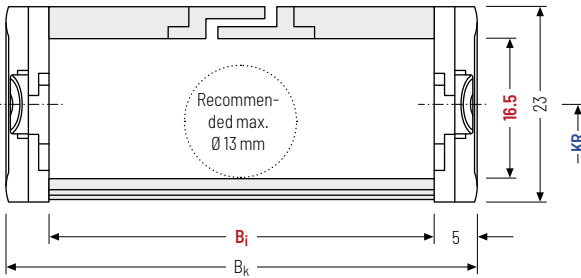

The maximum cable diameter strongly depends on the bending radius and the desired cable type. Please contact us.

Calculating the cable carrier length

Cable carrier length L_k

$$L_k \approx \frac{L_S}{2} + L_B$$

Cable carrier length L_k
rounded to pitch t

h_i [mm]	h_g [mm]	B_i [mm]	B_k [mm]	KR [mm]				q_k [kg/m]		
16.5	23	30 50	$B_i + 10$	28	38	45	60	75	100	0.32 – 0.36

Order example



ET0250

Type

030

Stay variant

50

B_i [mm]

75

KR [mm]

1,110

L_k [mm]

VS

Stay arrangement

Stay variant 040 – with lamellae in the inner radius

- » Weight-optimised plastic frame with particularly high torsional rigidity.
- » Lamellae can be swivelled at any position on one side
- » **Inside:** swivelling.

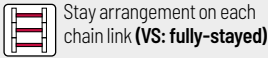

Stay arrangement on each chain link (VS: fully-stayed)



B_i 30 - 50 mm

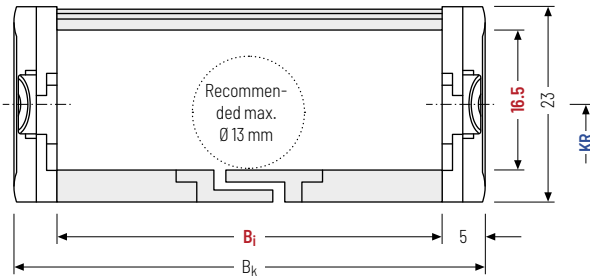

i The maximum cable diameter strongly depends on the bending radius and the desired cable type. Please contact us.

i Design 040 is not suitable for gliding arrangements.

Calculating the cable carrier length

Cable carrier length L_k

$$L_k \approx \frac{L_S}{2} + L_B$$

Cable carrier length L_k rounded to pitch t

h_i [mm]	h_g [mm]	B_i [mm]	B_k [mm]	KR [mm]					q_k [kg/m]	
16.5	23	30 50	$B_i + 10$	28	38	45	60	75	100	0.32 - 0.36

Order example

ET0250 Type ·
 040 Stay variant ·
 50 B_i [mm] ·
 75 KR [mm] ·
 1,100 L_k [mm] ·
 VS Stay arrangement

Cable carrier
Cable carrier configuration
Configuration guidelines
Materials information
MONO series
QuickTrax® series
UNIFLEX Advanced series
TKP35 series
TKK series

Divider systems

The divider system is mounted on every 2nd chain link as a standard.

As a standard, dividers or the complete divider system (dividers with height separations) are movable in the cross section (**version A**).

For applications with lateral accelerations and applications with the cable carrier rotated by 90°, the dividers can easily be fixed on the stay through rotation.

The arresting cams snap into the catch profiles in the covers (**version B**).

Divider system TSO without height separation

Vers.	a_T min [mm]	a_x min [mm]	a_c min [mm]	a_x grid [mm]	n_T min
A	3	6	4	-	-
B	3	6	4	2	-

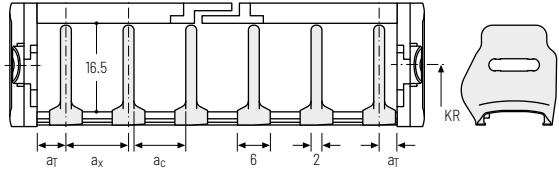

Order example



· ·
 Divider system Version n_T

Please state the designation of the divider system (TSO), the version, and the number of dividers per cross section [n_T]. You are welcome to add a sketch to your order.

Additional product information online



Installation instructions, etc.:
Additional info via your smartphone or
check online at
[tsubaki-kabelschlepp.com/
downloads](https://www.tsubaki-kabelschlepp.com/downloads)



Configure your cable carrier here:
[online-engineer.de](https://www.online-engineer.de)

Single-part end connectors – plastic (with integrated strain relief)

The plastic end connectors can be connected **from above or below**. The connection type can be changed by altering the position of the end connector.

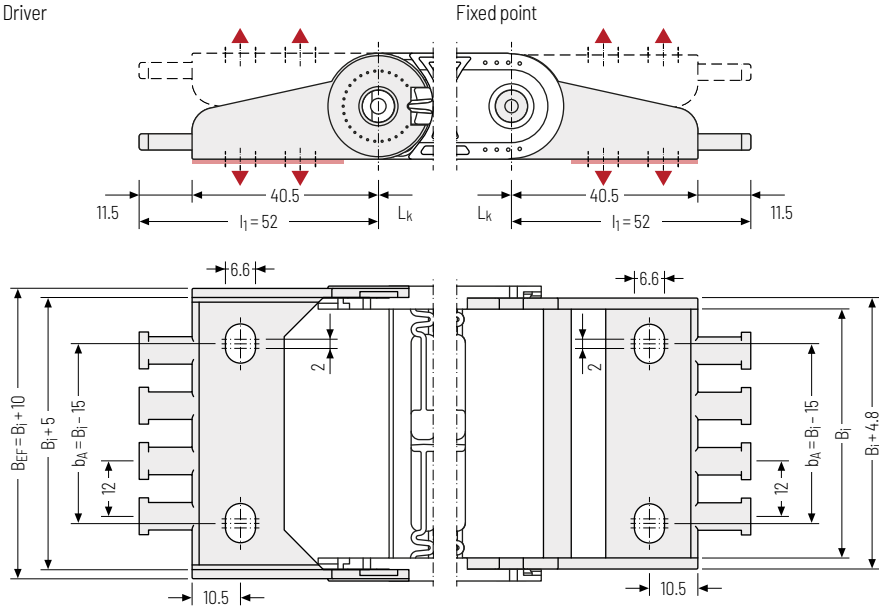

▲ Assembly options

B_i [mm]	B_{EF} [mm]	n_z
30	40	2
50	60	4

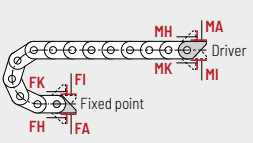

Connection point
F – fixed point
M – driver

Connection type
A – threaded joint outside (standard)
I – threaded joint inside
H – threaded joint, rotated 90° to the outside
K – threaded joint, rotated 90° to the inside

Order example

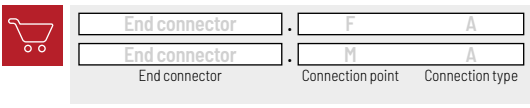

Cable carrier
Cable carrier configuration
Configuration guidelines
Materials information
MONO series
QuickTrax® series
UNIFLEX Advanced series
TKP35 series
TKK series

Subject to change without notice.

ET0320



Pitch
32 mm



Inner height
18 mm



Inner widths
15 – 65 mm



Bending radii
28 – 125 mm

Stay variants



Design 030 page 252

Frame with lamellae in the outer radius

- » Weight-optimised plastic frame with particularly high torsional rigidity.
- » Lamellae can be swivelled at any position on one side.
- » **Outside:** swivelling.



Design 040 page 253

Frame with lamellae in the inner radius

- » Weight-optimised plastic frame with particularly high torsional rigidity.
- » Lamellae can be swivelled at any position on one side.
- » **Inside:** swivelling.



TOTALTRAX® complete systems

Benefit from the advantages of the TOTALTRAX® complete system. A complete delivery from one source – with a warranty certificate on request! Learn more at tsubaki-kabelschlepp.com/totaltrax

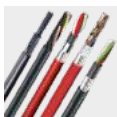

TRAXLINE® cables for cable carriers

Hi-flex electric cables which were specially developed, optimised and tested for use in cable carriers can be found at tsubaki-kabelschlepp.com/traxline.

Unsupported arrangement

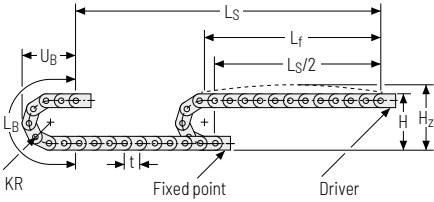

KR [mm]	H [mm]	H _z [mm]	L _B [mm]	U _B [mm]
28	81.5	101.5	152	73
38	101.5	121.5	184	83
48	121.5	141.5	215	93
75	175.5	195.5	300	120
100	225.5	245.5	379	145
125	275.5	295.5	457	170

Load diagram for unsupported length depending on the additional load.

Intrinsic cable carrier weight $q_k = 0.40 \text{ kg/m}$ with $B_j 38 \text{ mm}$. For other inner widths, the maximum additional load changes.

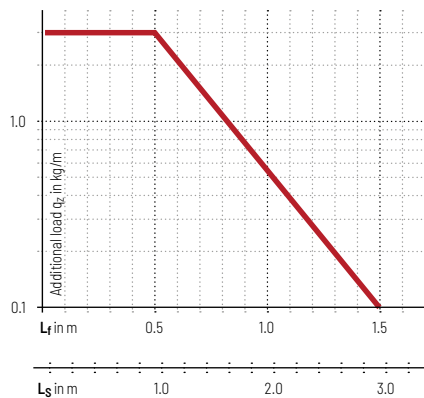

Speed
up to 10 m/s

Acceleration
up to 50 m/s^2

Travel length
up to 2.9 m

Additional load
up to 1.2 kg/m

Gliding arrangement

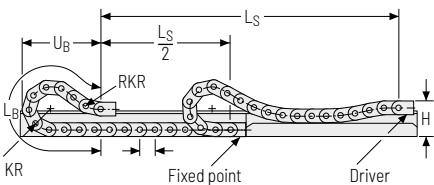

Speed
up to 2.5 m/s

Acceleration
up to 25 m/s^2

Travel length
up to 80 m

Additional load
up to 1.2 kg/m

The gliding cable carrier must be guided in a channel. See p. 844.

Only design 030 can be used for a gliding arrangement.

Cable carrier
Cable carrier configuration
Configuration guidelines
Materials information
MONO series
QuickTrax® series
UNIFLEX Advanced series
TKP35 series
TKK series
EasyTrax® series

Stay variant 030 – with lamellae in the outer radius

- » Weight-optimised plastic frame with particularly high torsional rigidity.
- » Lamellae can be swivelled at any position on one side
- » **Outside:** swivelling.



Stay arrangement on each chain link (**VS: fully-stayed**)



B_i 15 – 65 mm

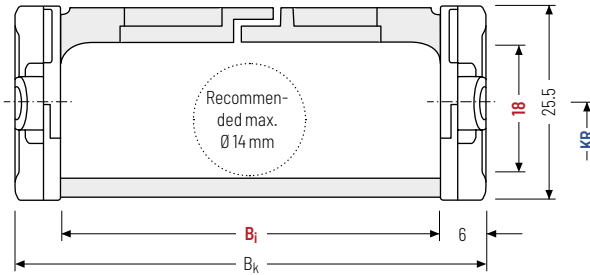

The maximum cable diameter strongly depends on the bending radius and the desired cable type. Please contact us.

Calculating the cable carrier length

Cable carrier length L_k

$$L_k \approx \frac{L_S}{2} + L_B$$

Cable carrier length L_k rounded to pitch t

h_i [mm]	h_g [mm]	B_i [mm]			B_k [mm]	KR [mm]				q_k [kg/m]				
18	25.5	15	25	38	50	65	$B_i + 12$	28	38	48	75	100	125	0.35 – 0.45

Order example



ET0320

Type

030

Stay variant

50

B_i [mm]

100

KR [mm]

1,280

L_k [mm]

VS

Stay arrangement

Stay variant 040 – with lamellae in the inner radius

- » Weight-optimised plastic frame with particularly high torsional rigidity.
- » Lamellae can be swivelled at any position on one side
- » **Inside:** swivelling.



 Stay arrangement on each chain link (**VS: fully-stayed**)

 B_i 15 – 65 mm

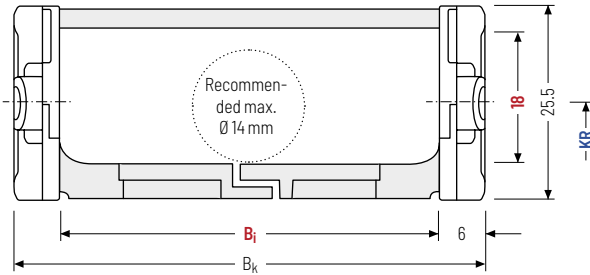

 The maximum cable diameter strongly depends on the bending radius and the desired cable type. Please contact us.

 Design 040 is not suitable for gliding arrangements.

Calculating the cable carrier length

Cable carrier length L_k

$$L_k \approx \frac{L_S}{2} + L_B$$

Cable carrier length L_k rounded to pitch t

h_i [mm]	h_g [mm]	B_i [mm]		B_k [mm]		KR [mm]				q_k [kg/m]				
18	25.5	15	25	38	50	65	$B_i + 12$	28	38	48	75	100	125	0.35 – 0.45

Order example

 **ET0320** (Type) · **040** (Stay variant) · **50** (B_i [mm]) · **100** (KR [mm]) · **1.280** (L_k [mm]) · **VS** (Stay arrangement)

- Cable carrier
- Cable carrier configuration
- Configuration guidelines
- Materials information
- MONO series
- QuickTrax® series
- UNIFLEX Advanced series
- TKP35 series
- TKK series

Divider systems

The divider system is mounted on every 2nd chain link as a standard.

As a standard, dividers or the complete divider system (dividers with height separations) are movable in the cross section (**version A**).

Divider system TSO without height separation

Vers.	a_T min [mm]	a_x min [mm]	a_c min [mm]	n_T min
A	4	8	6	-

The dividers can be moved in the cross section.

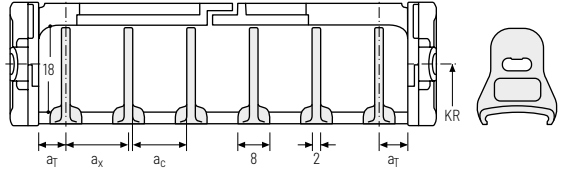

Order example



Please state the designation of the divider system (TSO), the version, and the number of dividers per cross section [n_T]. You are welcome to add a sketch to your order.

Additional product information online



Installation instructions, etc.:
Additional info via your smartphone or check online at
[tsubaki-kabelschlepp.com/downloads](https://www.tsubaki-kabelschlepp.com/downloads)



Configure your cable carrier here:
[online-engineer.de](https://www.online-engineer.de)

Single-part end connectors – plastic (with integrated strain relief)

The plastic end connectors can be **connected from above or below**. The connection type can be changed by altering the position of the end connector.

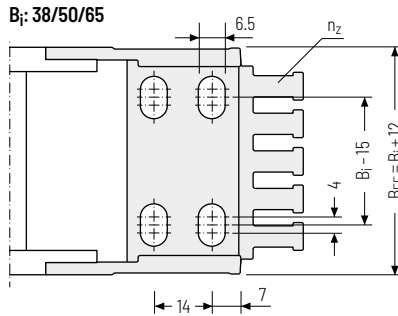
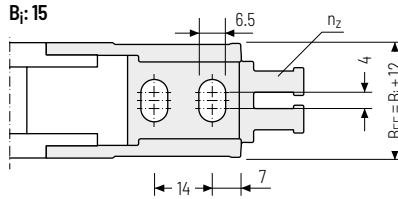
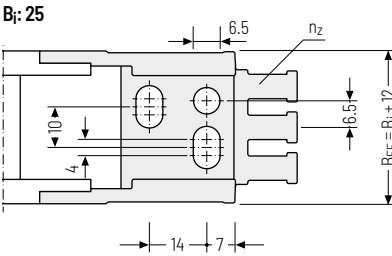
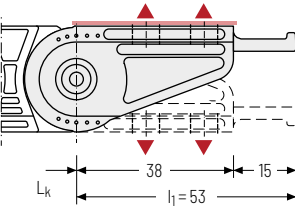

▲ Assembly options

B_i [mm]	B_{EF} [mm]	n_z
15	27	2
25	37	3
38	50	4
50	62	5
65	77	6

The end connectors are also available as an option **without** integrated strain relief. Please state when ordering.

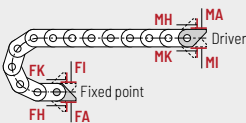

Connection point

- F** – fixed point
- M** – driver

Connection type

- A** – threaded joint outside (standard)
- I** – threaded joint inside
- H** – threaded joint, rotated 90° to the outside
- K** – threaded joint, rotated 90° to the inside

Order example

End connector . F A

 End connector . M A

 End connector Connection point Connection type

Cable carrier
Cable carrier configuration
Configuration guidelines
Materials information
MONO series
QuickTrax® series
UNIFLEX Advanced series
TKP35 series
TKK series
EasyTrax® series

ET1455

Cable carrier

Cable carrier configuration

Configuration guidelines

Materials information

MONO series

QuickTrax® series

UNIFLEX Advanced series

TKP35 series

TKK series

EasyTrax® series



Pitch
45.5 mm



Inner height
25 mm



Inner width
25 – 78 mm



Bending radii
52 – 200 mm

Stay variants



Design 030 page 258

Frame with lamellae in the outer radius

- » Weight-optimised plastic frame with particularly high torsional rigidity.
- » Lamellae can be swivelled at any position on one side.
- » **Outside:** swivelling.



Design 040 page 259

Frame with lamellae in the inner radius

- » Weight-optimised plastic frame with particularly high torsional rigidity.
- » Lamellae can be swivelled at any position on one side.
- » **Inside:** swivelling.



TOTALTRAX® complete systems

Benefit from the advantages of the TOTALTRAX® complete system. A complete delivery from one source – with a warranty certificate on request! Learn more at tsubaki-kabelschlepp.com/totaltrax

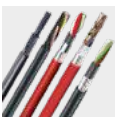

TRAXLINE® cables for cable carriers

Hi-flex electric cables which were specially developed, optimised and tested for use in cable carriers can be found at tsubaki-kabelschlepp.com/traxline.

Unsupported arrangement

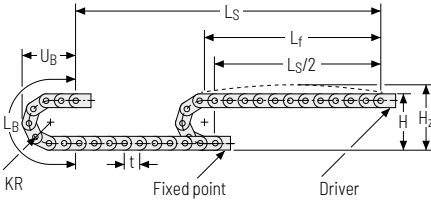

KR [mm]	H [mm]	H _z [mm]	L _B [mm]	U _B [mm]
52	140	165	255	116
65	166	191	296	129
95	226	251	390	159
125	286	211	484	189
150	336	361	563	214
180	396	421	657	244
200	436	461	720	264

Load diagram for unsupported length depending on the additional load.

Intrinsic cable carrier weight $q_k = 0.75 \text{ kg/m}$ with $B_i 38 \text{ mm}$. For other inner widths, the maximum additional load changes.

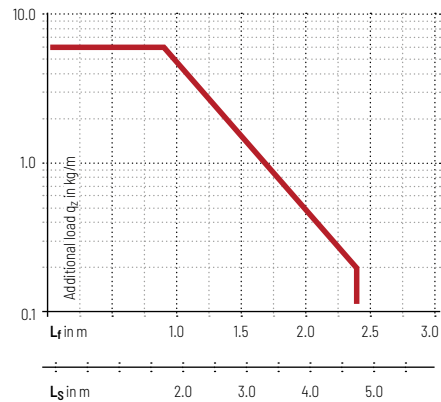

Speed
up to 10 m/s

Acceleration
up to 50 m/s^2

Travel length
up to 4.8 m

Additional load
up to 6.0 kg/m

Cable carrier

Cable carrier configuration

Configuration guidelines

Materials information

MONO series

QuickTrax® series

UNIFLEX Advanced series

TKP35 series

TKK series

EasyTrax® series

Stay variant 030 – with lamellae in the outer radius

- » Weight-optimised plastic frame with particularly high torsional rigidity.
- » Lamellae can be swivelled at any position on one side
- » **Outside:** swivelling.



Stay arrangement on each chain link (**VS: fully-stayed**)



B_i : 25 – 78 mm

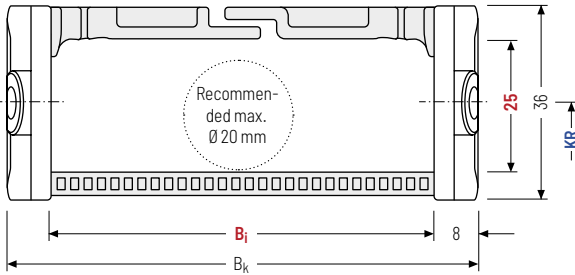

The maximum cable diameter strongly depends on the bending radius and the desired cable type. Please contact us.

Calculating the cable carrier length

Cable carrier length L_k

$$L_k \approx \frac{L_S}{2} + L_B$$

Cable carrier length L_k rounded to pitch t

h_i [mm]	h_G [mm]	h_G' [mm]	B_i [mm]				B_k [mm]	KR [mm]				q_k [kg/m]
25	36	38.5	25	38	58	78	$B_i + 16$	52	65	95	125	0.65 – 0.80
								150	180	200		

Order example



ET1455

Type

030

Stay variant

78

B_i [mm]

150

KR [mm]

1,456

L_k [mm]

VS

Stay arrangement

Stay variant 040 – with lamellae in the inner radius

- » Weight-optimised plastic frame with particularly high torsional rigidity.
- » Lamellae can be swivelled at any position on one side
- » **Inside:** swivelling.

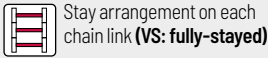

Stay arrangement on each chain link (VS: fully-stayed)



B_i 25 – 78 mm

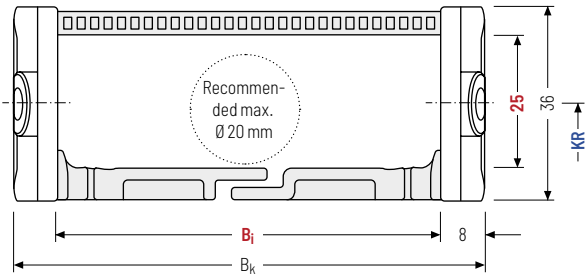

i The maximum cable diameter strongly depends on the bending radius and the desired cable type. Please contact us.

i Design 040 is not suitable for gliding arrangements.

Calculating the cable carrier length

Cable carrier length L_k

$$L_k \approx \frac{L_S}{2} + L_B$$

Cable carrier length L_k rounded to pitch t

h_i [mm]	h_g [mm]	h_{g^*} [mm]	B_i [mm]				B_k [mm]	KR [mm]				q_k [kg/m]
25	36	38.5	25	38	58	78	$B_i + 16$	52	65	95	125	0.65 – 0.80
								150	180	200		

Order example

ET1455
Type
·
040
Stay variant
·
78
 B_i [mm]
·
150
 KR [mm]
·
1,456
 L_k [mm]
·
VS
Stay arrangement

	Cable carrier
	Cable carrier configuration
	Configuration guidelines
	Materials information
	MONO series
	QuickTrax® series
	UNIFLEX Advanced series
	TKP35 series
	TKK series

Single-part end connectors – plastic

The plastic end connectors can be **connected from above or below**. The connection type can be changed by altering the position of the end connector.

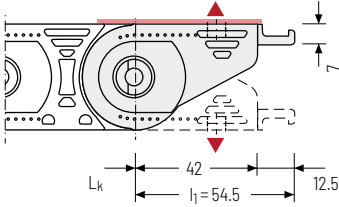

▲ Assembly options

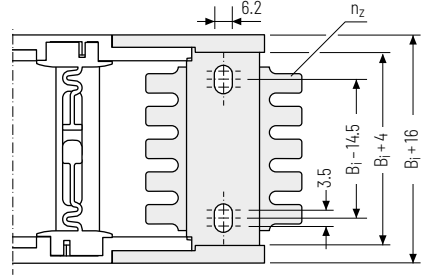

Recommended tightening torque:
6 Nm for screws M6 - 8.8

B_1 [mm]	n_z
25	2 x 2
38	2 x 3
58	2 x 4
78	2 x 6

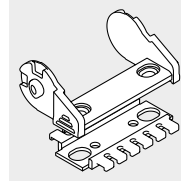

The end connectors are optionally also available **without** strain relief comb. Please state when ordering.

Cable carrier

Cable carrier configuration

Configuration guidelines

Materials information

MONO series

QuickTrax® series

UNIFLEX Advanced series

TKP35 series

TKK series

EasyTrax® series

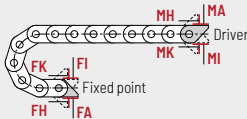

Connection point

- F – fixed point
- M – driver

Connection type

- A – threaded joint outside (standard)
- I – threaded joint inside
- H – threaded joint, rotated 90° to the outside
- K – threaded joint, rotated 90° to the inside

Order example



End connector	.	F	A
End connector	.	M	A
End connector		Connection point	Connection type

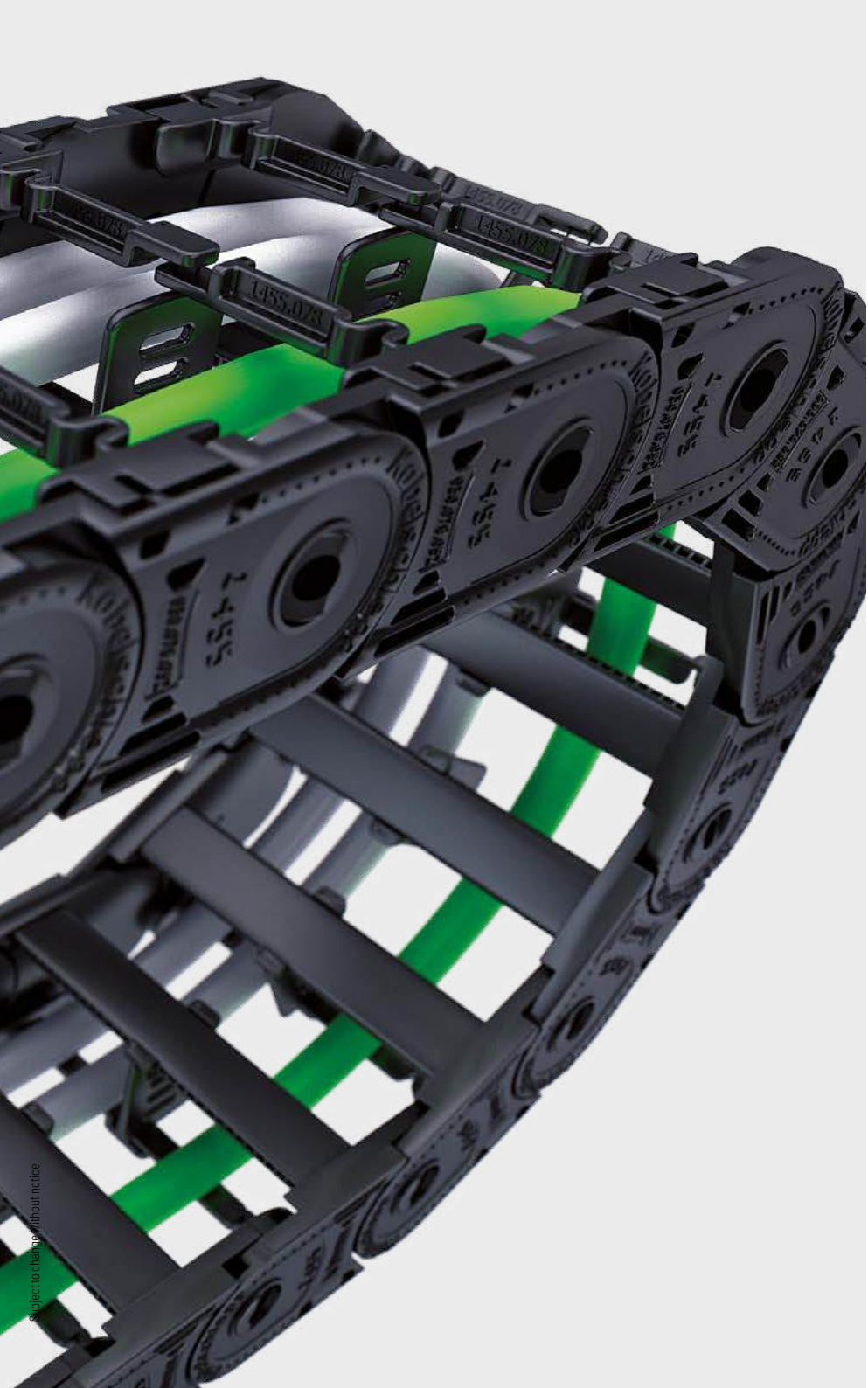

Subject to change without notice.

TKK series	TKP35 series	UNIFLEX Advanced series	QuickTrax® series	MONO series	Materials information	Configuration guidelines	Cable carrier configuration	Cable carrier
------------	--------------	-------------------------	-------------------	-------------	-----------------------	--------------------------	-----------------------------	---------------