

# LS/LSX series

Cost-effective steel chains  
with light design

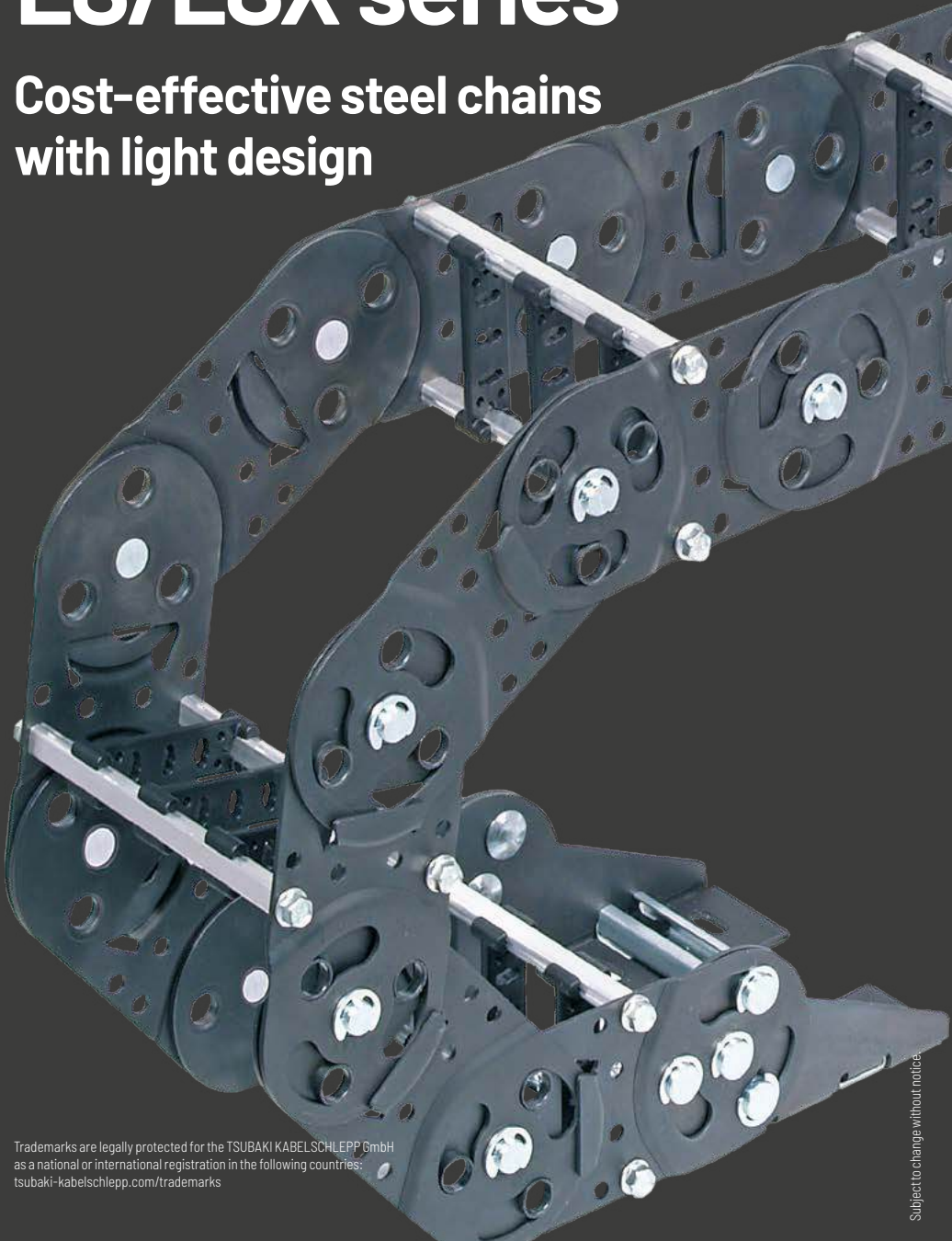
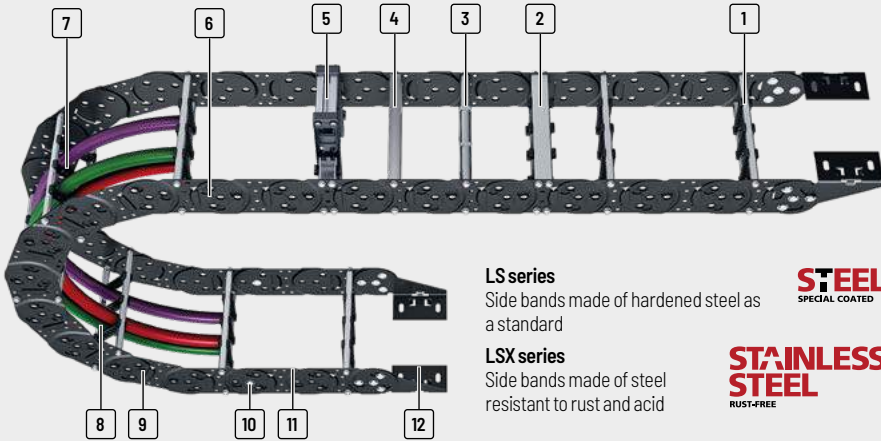

Trademarks are legally protected for the TSUBAKI KABELSCHLEPP GmbH as a national or international registration in the following countries:  
[tsubaki-kabelschlepp.com/trademarks](http://tsubaki-kabelschlepp.com/trademarks)

**LS series**

Side bands made of hardened steel as a standard

**STEEL**  
SPECIAL COATED

**LSX series**

Side bands made of steel resistant to rust and acid

**STAINLESS STEEL**  
RUST-FREE

- 1 All stays available in **1 mm width sections**
- 2 4-fold bolted aluminum stays for extreme loads
- 3 Rolling stays
- 4 Aluminum hole stays

- 5 Mounting frame stays
- 6 Stops integrated into link plate - no additional bolts required
- 7 Different separation options for the cables
- 8 Plastic or steel dividers

- 9 Weight-optimized side bands made of hardened steel or stainless steel
- 10 Optional center bolt for applications with high loads

- 11 Good ratio of inner to outer width - no end divider required
- 12 End connectors for different connection variants

## Features

- » Weight-optimized one-part link plate design
- » Better value than comparable steel cable carriers
- » Significantly higher unsupported lengths compared to plastic cable carriers of a similar size
- » Integrated radius and pre-tension stops - in a good value design
- » Bolted stay systems, solid end connectors
- » Cover with steel band available on request
- » Also possible as a double band solution
- » Good corrosion resistance

### The design

The weight-optimized link plate design makes the cable carriers very light yet highly sturdy. For the LS series, the unsupported length is significantly higher compared to plastic cable carriers of a similar size.



**Weight-optimized link plates consist of only one plate - the stop system is integrated**



**Lightweight side bands with-out additional bolts - hardened steel or stainless steel**



**Optional: Center bolts and circlip for applications with high loads**



**Optional: C-rail for strain relief elements attached in the connection**

Type	Opening variant	Stay variant	$h_i$ [mm]	$h_G$ [mm]	$B_i$ [mm]	$B_k$ [mm]	$B_i$ - grid [mm]	t [mm]	KR [mm]	Additional load ≤ [kg/m]	Cable- d <sub>max</sub> [mm]
MT series											
<b>LS/LSX1050</b>											
XLT series		RS2	58	80	84 - 384	100 - 400	1	105	105 - 430	35	46
		RV	58	80	84 - 584	100 - 600	1	105	105 - 430	35	46
ROBOTRAX® System		RR	54	80	84 - 484	100 - 500	1	105	105 - 430	35	43
		LG	48	80	54 - 554	100 - 600	1	105	105 - 430	35	38
FLATVEYOR®		RMA	58 (200)	80 (226)	184 - 384	200 - 400	1	105	105 - 430	35	-

## Sturdy and durable, even under extreme conditions

### Double-band steel cable carrier LS1050

- » Up to 40% longer unsupported lengths compared to LS1050 with standard side band with the same additional load, as part of the load diagram
- » Very high additional loads: up to 40 kg/m possible
- » Long service life even with high dynamic loads
- » High travel speeds



## Longer service life through hardened side bands

The hardened surface significantly increases the service life of the LS1050. Tests were carried out on cable carriers with identical designs.

The LS1050 is therefore ideal for applications with many travel cycles, for example in 3-shift operation.

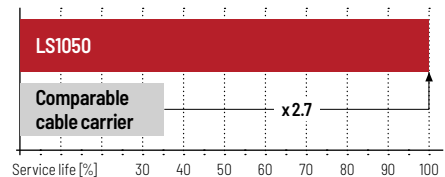

MT series

XLT series

ROBOTRAX® System

FLATVEYOR®

CLEANVEYOR®

LS/LSX series

S/SX series

S/SX-Tubes series

Accessories

TRAXLINE®

Unsupported arrangement			Gliding arrangement			Inner Distribution				Movement			Page
Travel length $\leq$ [m]	$v_{max} \leq$ [m/s]	$a_{max} \leq$ [m/s <sup>2</sup> ]	Travel length $\leq$ [m]	$v_{max} \leq$ [m/s]	$a_{max} \leq$ [m/s <sup>2</sup> ]	TS0	TS1	TS2	TS3	vertical hanging or standing	lying on the side	rotating arrangement	
9.5	5	10	-	-	-	•	•	•	•	•	-	-	674
9.5	5	10	-	-	-	•	•	•	•	•	-	-	678
9.5	5	10	-	-	-	•	•	-	-	•	-	-	682
9.5	5	10	-	-	-	-	-	-	-	•	-	-	684
9.5	5	10	-	-	-	•	-	-	-	•	-	-	686

## Significantly higher unsupported lengths compared to plastic cable carriers of a similar size

Load diagram for unsupported length depending on the additional load

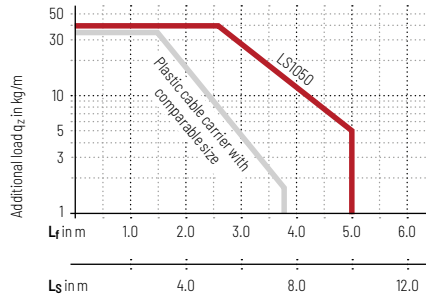
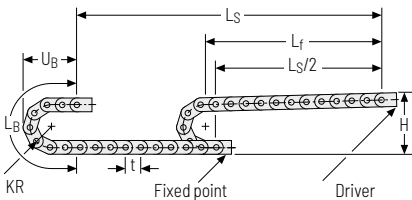

## Weight-optimized through adapted link plate design

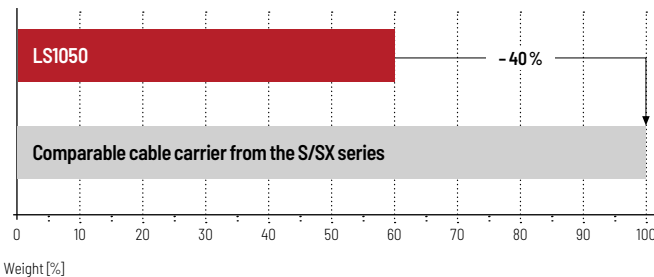

Subject to change without notice.

MT series

XLT series

ROBOTRAX® System

FLATVEYOR®

CLEANVEYOR®

LS/LSX series

S/SX series

S/SX-Tubes series

Accessories

TRAXLINE®

# LS/LSX1050



**Pitch**  
105 mm



**Inner height**  
48 – 58 mm



**Chain widths**  
100 – 600 mm



**Bending radii**  
105 – 430 mm

## Stay variants



**Aluminum stay RS 2** ..... page 674

### Frame stay narrow, bolted

- » Quick to open and close.
- » Aluminum profile bars for light to medium loads. Easy threaded connection.
- » **Inside/outside:** Threaded joint easy to release.



**Aluminum stay RV** ..... page 678

### Frame stay, reinforced

- » Aluminum profile bars for medium to heavy loads and large cable carrier widths. Double threaded joint on both sides.
- » **Inside/outside:** Threaded joint easy to release.



**Tube stay RR** ..... page 682

### Frame stay, tube version

- » Steel rolling stays with gentle cable support and steel dividers. Ideal for using media hoses with soft sheathing.
- » **Inside/outside:** Screw connection detachable.



**Aluminum stay LG** ..... page 684

### Frame stay, split

- » Optimum cable routing in the neutral bending line. Split version for easy cable routing. Stays also available unsplit.
- » **Inside/outside:** Threaded joint easy to release.



**Aluminum stay RMA** ..... page 686

### Mounting frame stay

- » Aluminum profile bars with plastic mounting frame stays for guiding very large cable diameters.
- » **Outside/inside:** Screw-fixing easy to release.

Unsupported arrangement

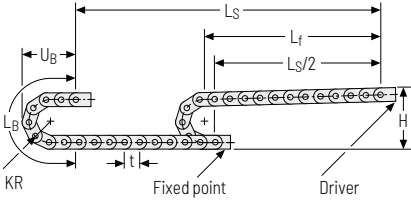

KR [mm]	H [mm]	L <sub>B</sub> [mm]	U <sub>B</sub> [mm]
105	330	540	250
125	370	603	270
155	430	697	300
195	510	823	340
260	640	1027	405
295	710	1137	440
325	770	1231	470
365	850	1357	510
430	980	1561	575

Installation height H<sub>z</sub>

$H_z = H + 10 \text{ mm/m}$

Load diagram for unsupported length depending on the additional load.

Intrinsic cable carrier weight  $q_k = 3.8 \text{ kg/m}$ . For other inner widths, the maximum additional load changes.

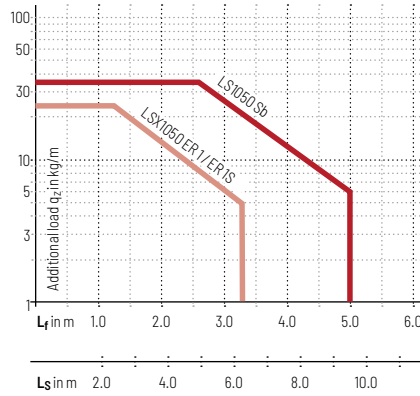

**Speed**  
up to 5 m/s

**Acceleration**  
up to 10 m/s<sup>2</sup>

**Travel length**  
up to 9.5 m

**Additional load**  
up to 35 kg/m



Information on selecting center bolts and stay arrangement

- » Cable carrier length < 4 m: half-stayed arrangement as a standard
- » Cable carrier length > 4 m: fully-stayed arrangement required
- » Stay width B<sub>St</sub> > 400 mm: fully-stayed arrangement required
- » Travel speed > 2.5 m/s: fully-stayed arrangement required
- » Use of support rollers: Center bolt **and** fully-stayed arrangement required

MT series
XLT series
ROBOTRAX® System
FLATVEYOR®
CLEANVEYOR®
LS/LSX series
S/SX series
S/SX-Tubes series
Accessories
TRAXLINE®

## Aluminum stay RS 2 – frame stay narrow, threaded joint

- » Quick to open and close
- » Aluminum profile bars for light to medium loads.  
Simple threaded joint.
- » Available customized in **1 mm grid**.
- » **Inside/outside:** Threaded joint easy to release.

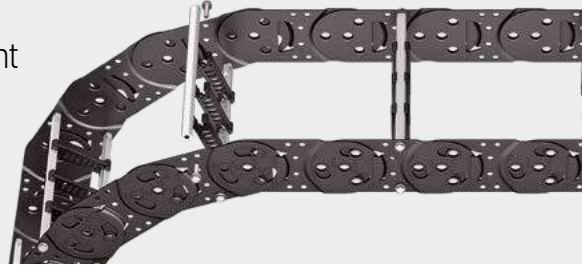

Stay arrangement on every  
2<sup>nd</sup> chain link, **standard**  
(**HS: half-stayed**)



Stay arrangement on each  
chain link (**VS: fully-stayed**)



**1 mm** B<sub>k</sub> 100 – 400 mm  
in **1 mm** width sections

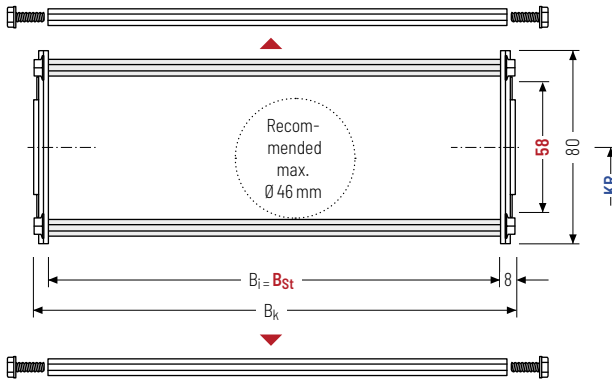

The maximum cable diameter strongly depends on the bending radius and the desired cable type. Please contact us.

### Calculating the cable carrier length

#### Cable carrier length L<sub>k</sub>

$$L_k \approx \frac{L_S}{2} + L_B$$

Cable carrier length L<sub>k</sub>  
rounded to pitch t

h <sub>i</sub> [mm]	h <sub>G</sub> [mm]	B <sub>i</sub> [mm]	B <sub>St</sub> [mm]*	B <sub>k</sub> [mm]	KR [mm]					q <sub>k</sub> [kg/m]
58	80	84 384	84 384	B <sub>St</sub> + 16	105 295	125 325	155 365	195 430	260	3,63 4,11

\* in 1 mm width sections

### Order example



LS1050

Type

180

B<sub>St</sub> [mm]

RS 2

Stay variant

125

KR [mm]

Sb

Material

2415

L<sub>k</sub> [mm]

HS

Stay arrangement

**Divider systems**

As a standard, the divider system is mounted on each crossbar – for stay mounting on every 2<sup>nd</sup> chain link (HS).

For applications with lateral acceleration and rotated by 90°, the dividers can be attached by simply clipping on a socket (available as an accessory).

As a standard, dividers and the complete divider system (dividers with height separations) can be moved in the cross section (**version A**).

The socket additionally serves as a spacer between the dividers and is available in 1 mm sections between 3 – 50 mm as well as 16.5 and 21.5 mm (**version B**).

**Divider system TS0 without height separation**

Vers.	a <sub>T</sub> min [mm]	a <sub>x</sub> min [mm]	a <sub>c</sub> min [mm]	π <sub>T</sub> min
A	7	14	10	-

The dividers can be moved in the cross section.

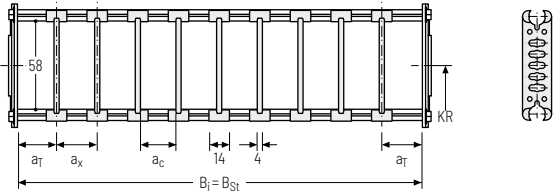

**Divider system TS1 with continuous height separation**

Vers.	a <sub>T</sub> min [mm]	a <sub>T</sub> max [mm]	a <sub>x</sub> min [mm]	a <sub>c</sub> min [mm]	π <sub>T</sub> min
A	7	25	14	10	2

The dividers can be moved in the cross section.

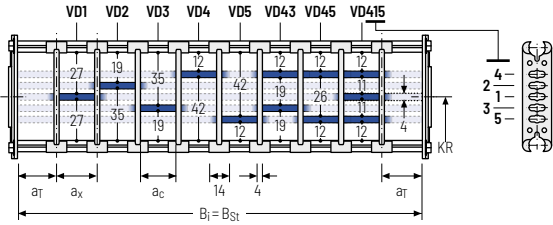



**Divider system TS2 with partial height separation**

Vers.	a <sub>T</sub> min [mm]	a <sub>x</sub> min [mm]	a <sub>c</sub> min [mm]	π <sub>T</sub> min
A	7	23	19	2

With grid distribution (1mm grid). The dividers are attached by the height separation, the grid can be moved in the cross section.

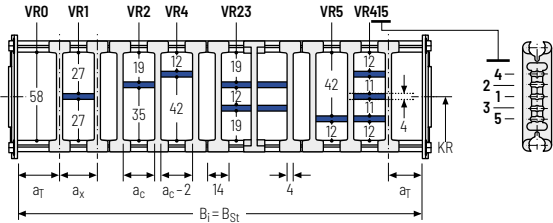
Sliding dividers are optionally available (thickness of divider = 4 mm).



 Please note that the real dimensions may deviate slightly from the values indicated here.

**Order example**

 TS2 · A · 3 · K1 · 34 · VR1

⋮ ⋮ ⋮

K4 · 38 · VR3

Divider system      Version      π<sub>T</sub>      Chamber      a<sub>x</sub>      Height separation

MT series
XLT series
ROBOTRAX® System
FLATVEVOR®
CLEANVEVOR®
LS/LSX series
S/SX series
S/SX-Tubes series
Accessories
TRAXLINE®



## Divider system TS3 with height separation consisting of plastic partitions

As a standard, the divider **version A** is used for vertical partitioning within the cable carrier. The complete divider system can be moved within the cross section.

Divider version A

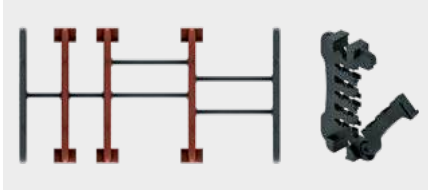

End divider

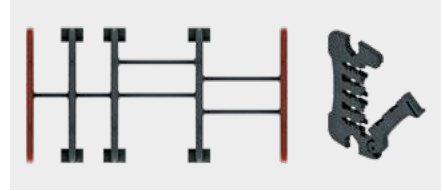

Vers.	$a_T$ min [mm]	$a_x$ min [mm]	$a_c$ min [mm]	$n_T$ min
A	6 / 2*	14	10	2

\* For End divider

The dividers are fixed by the partitions, the complete divider system is movable in the cross section.

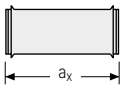
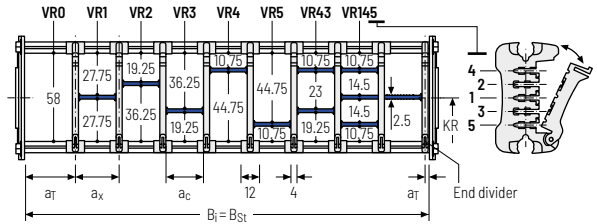

$a_x$ (center distance of dividers) [mm]																
$a_c$ (nominal width of inner chamber) [mm]																
14	16	19	23	24	28	29	32	33	34	38	39	43	44	48	49	54
10	12	15	19	20	24	25	28	29	30	34	35	39	40	44	45	50
58	59	64	68	69	74	78	79	80	84	88	89	94	96	99	112	
54	55	60	64	65	70	74	75	76	80	84	85	90	92	95	108	

When using **partitions with  $a_x > 49$  mm** we recommend an additional preferential central support.

### Order example



TS3	A	3	K1	34	VR1
			:	:	:
			K4	38	VR3
Divider system	Version	$n_T$	Chamber	$a_x$	Height separation

Please state the designation of the divider system (TS0, TS1,...), version and number of dividers per cross section [ $n_T$ ]. In addition, please also enter the chambers [K] from left to right, as well as the assembly distances [ $a_T/a_x$ ] (as seen from the driver).

If using divider systems with height separation (TS1, TS3) please also state the positions [e.g. VD23] viewed from the left driver belt. You are welcome to add a sketch to your order.



Subject to change without notice

TRAXLINE®

Accessories

S/SX-Tubes  
series

S/SX  
series

LS/LSX  
series

CLEANVEYOR®

FLATVEYOR®

ROBOTRAX®  
System

XLT  
series

MT  
series

## Aluminum stay RV – frame stay reinforced

- » Aluminum profile bars for medium to heavy loads and large cable carrier widths. Double threaded joint on both sides.
- » Available customized in **1 mm grid**.
- » **Inside/outside:** Threaded joint easy to release.



Stay arrangement on every 2<sup>nd</sup> chain link, **standard** (HS: half-stayed)



Stay arrangement on each chain link (**VS: fully-stayed**)



**1 mm** B<sub>k</sub> 100 – 600 mm in 1 mm width sections

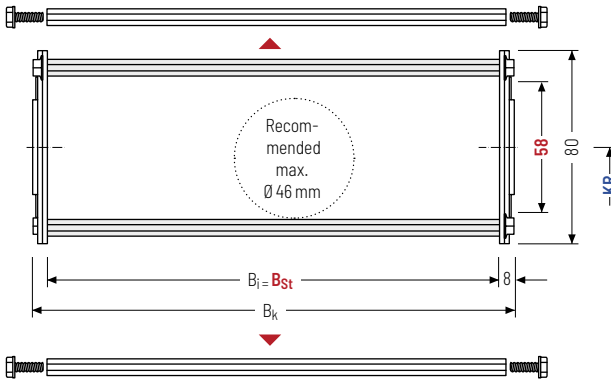

The maximum cable diameter strongly depends on the bending radius and the desired cable type. Please contact us.

### Calculating the cable carrier length

#### Cable carrier length L<sub>k</sub>

$$L_k \approx \frac{L_S}{2} + L_B$$

Cable carrier length L<sub>k</sub> rounded to pitch t

h <sub>i</sub> [mm]	h <sub>G</sub> [mm]	B <sub>i</sub> [mm]	B <sub>St</sub> [mm]*	B <sub>k</sub> [mm]	KR [mm]					q <sub>k</sub> [kg/m]
58	80	84	84 584	B <sub>St</sub> + 16	105	125	155	195	260	4.00
		584			295	325	365	430	5.95	

\* in 1 mm width sections

### Order example



LS1050

Type

180

B<sub>St</sub> [mm]

RV

Stay variant

125

KR [mm]

Sb

Material

2415

L<sub>k</sub> [mm]

HS

Stay arrangement

**Divider systems**

As a standard, the divider system is mounted on each crossbar – for stay mounting on every 2<sup>nd</sup> chain link (HS).

As a standard, dividers and the complete divider system (dividers with height separations) can be moved in the cross section (**version A**).

**Divider system TSO without height separation**

Vers.	a <sub>T</sub> min [mm]	a <sub>x</sub> min [mm]	a <sub>c</sub> min [mm]	π <sub>T</sub> min
A	7	14	10	-

The dividers can be moved in the cross section.

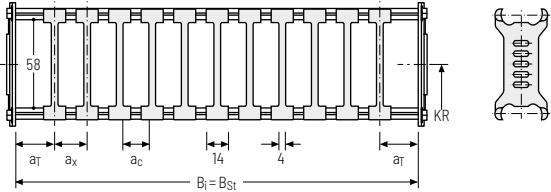

**Divider system TS1 with continuous height separation**

Vers.	a <sub>T</sub> min [mm]	a <sub>T</sub> max [mm]	a <sub>x</sub> min [mm]	a <sub>c</sub> min [mm]	π <sub>T</sub> min
A	7	25	14	10	2

The dividers can be moved in the cross section.

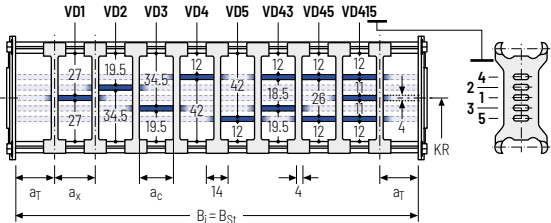

**Divider system TS2 with partial height separation**

Vers.	a <sub>T</sub> min [mm]	a <sub>x</sub> min [mm]	a <sub>c</sub> min [mm]	π <sub>T</sub> min
A	8	21	15	2

With grid distribution (1 mm grid). The dividers are attached by the height separation, the grid can be moved in the cross section.

Sliding dividers are optionally available (thickness of divider = 4 mm).

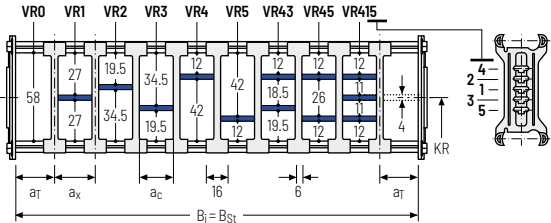

MT series
XLT series
ROBOTRAX® System
FLATVEVOR®
CLEANVEVOR®
LS/LSX series
S/SX series
S/SX-Tubes series
Accessories
TRAXLINE®

Subject to change without notice.



**TRAXLINE® cables for cable carriers**  
 Hi-flex electric cables which were especially developed, optimized and tested for use in cable carriers can be found at [tsubaki-kabelschlepp.com/traxline](http://tsubaki-kabelschlepp.com/traxline)

## Divider system TS3 with height separation made of plastic partitions

Vers.	$a_T$ min [mm]	$a_x$ min [mm]	$a_c$ min [mm]	$n_T$ min
A	4	16 / 42*	8	2

\* For aluminum partitions

The dividers are fixed by the partitions, the complete divider system is movable in the cross section.

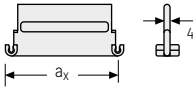
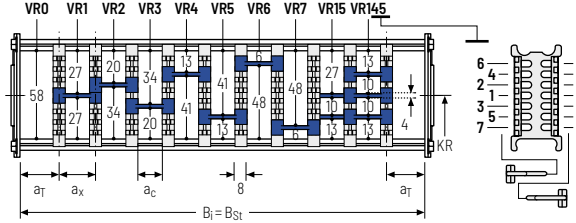

Aluminum partitions in 1 mm increments with  $a_x > 42$  mm are also available.

$a_x$ (center distance of dividers) [mm]											
$a_c$ (nominal width of inner chamber) [mm]											
16	18	23	28	32	33	38	43	48	58	64	68
8	10	15	20	24	25	30	35	40	50	56	60
78	80	88	96	112	128	144	160	176	192	208	
70	72	80	88	104	120	136	152	168	184	200	

When using **plastic partitions with  $a_x > 112$  mm**, we recommend an additional center support with a **twin divider** ( $S_T = 4$  mm). Twin dividers are also suitable for retrofitting in the partition system.

### Order example



TS3	A	3	K1	34	VR1
			⋮	⋮	⋮
			K4	38	VR3
Divider system	Version	$n_T$	Chamber	$a_x$	Height separation

Please state the designation of the divider system (**TS0, TS1...**), version and number of dividers per cross section [ $n_T$ ]. In addition, please also enter the chambers [K] from left to right, as well as the assembly distances [ $a_T/a_x$ ] (as seen from the driver).

If using divider systems with height separation (**TS1, TS3**) please also state the positions [e.g. VD23] viewed from the left carrier belt. You are welcome to add a sketch to your order.

### More product information online



Assembly instructions etc.:  
Additional info via your smartphone or check online at  
[tsubaki-kabelschlepp.com/downloads](http://tsubaki-kabelschlepp.com/downloads)



Configure your cable carrier here:  
[online-engineer.de](http://online-engineer.de)



MT  
seriesXLT  
seriesROBOTRAX®  
System

FLATVEYOR®

CLEANVEYOR®

LS/LSX  
seriesS/SX  
seriesS/SX-Tubes  
series

Accessories

TRAXLINE®

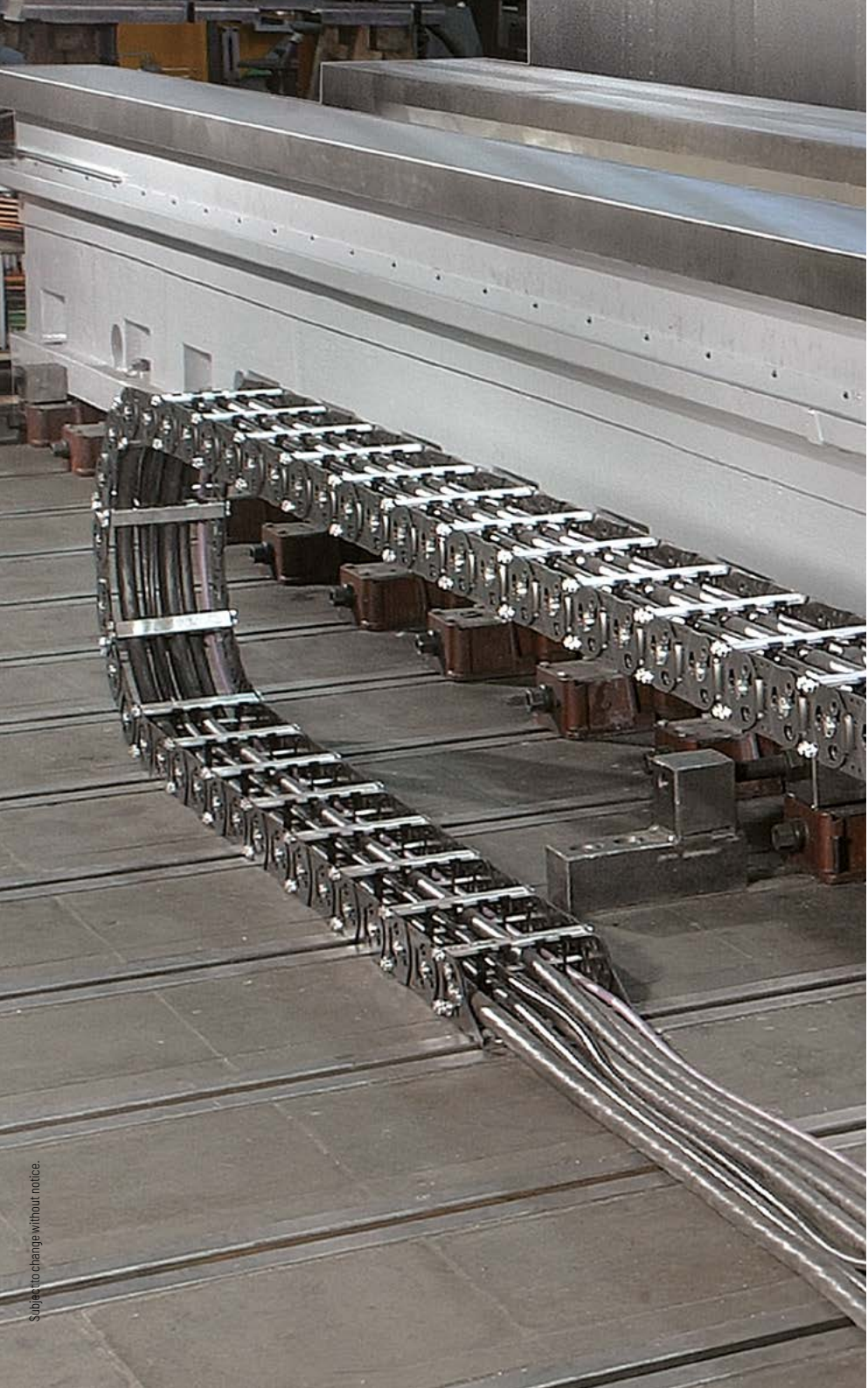

## Tube stay RR – frame stay, tube version

- » Steel rolling stays with gentle cable support and steel dividers. Ideal for using media hoses with soft sheathing. Easy screw connection.
- » Available customized in **1 mm width sections**.
- » **Inside/outside: Screw connection detachable**
- » **Option:** Divider systems made from steel and stainless steel ER 1, ER 1S.



Stay arrangement on every 2<sup>nd</sup> chain link, **standard (HS: half-stayed)**



Stay arrangement on each chain link (**VS: fully-stayed**)



**1 mm** B<sub>k</sub> 100 – 500 mm in **1 mm width sections**

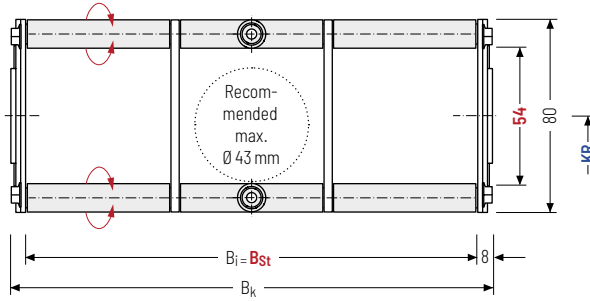

The maximum cable diameter strongly depends on the bending radius and the desired cable type. Please contact us.

### Calculating the cable carrier length

#### Cable carrier length L<sub>k</sub>

$$L_k \approx \frac{L_S}{2} + L_B$$

Cable carrier length L<sub>k</sub> rounded to pitch t

h <sub>i</sub> [mm]	h <sub>G</sub> [mm]	B <sub>i</sub> [mm]	B <sub>St</sub> [mm]*	B <sub>k</sub> [mm]	KR [mm]					q <sub>k</sub> [kg/m]
54	80	84 484	84 484	B <sub>St</sub> + 16	105	125	155	195	260	4.25
					295	325	365	430		7.80

\* in 1 mm width sections



**LS1050**

Type

**180**

B<sub>St</sub> [mm]

**RR**

Stay variant

**125**

KR [mm]

**Sb**

Material

**2415**

L<sub>k</sub> [mm]

**HS**

Stay arrangement

**Divider systems**

As a standard, the divider system is mounted on each crossbar – for stay mounting on every 2<sup>nd</sup> chain link (HS).

The dividers are fixed through the tubes. The tube additionally serves as a spacer between the dividers (**version B**).

**Divider system TSO without height separation**

Vers.	a <sub>T</sub> min [mm]	a <sub>x</sub> min [mm]	a <sub>c</sub> min [mm]	n <sub>T</sub> min
B	20	20	16	-

The dividers can be moved in the cross section.

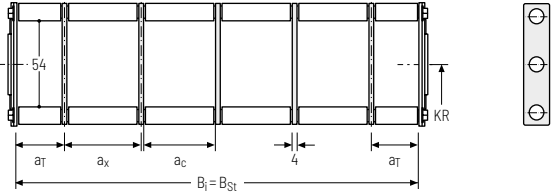

**Divider system TS1 with continuous height separation**

Vers.	a <sub>T</sub> min [mm]	a <sub>T</sub> max [mm]	a <sub>x</sub> min [mm]	a <sub>c</sub> min [mm]	n <sub>T</sub> min
B	20	25	20	16	2

The dividers can be moved in the cross section.

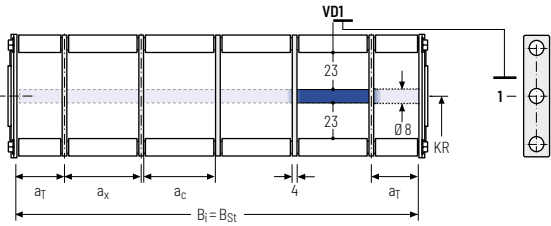

**Order example**

TS1

B

3

K1

34

VDO

⋮  
 ⋮  
 ⋮

K4

38

VDO

Divider system      Version      n<sub>T</sub>      Chamber      a<sub>x</sub>      Height separation

Please state the designation of the divider system (**TS0, TS1...**), version and number of dividers per cross section [n<sub>T</sub>]. In addition, please also enter the chambers [K] from left to right, as well as the assembly distances [a<sub>T</sub>/a<sub>x</sub>] (as seen from the driver).

**TRAXLINE® cables for cable carriers**



Hi-flex electric cables which were especially developed, optimized and tested for use in cable carriers can be found at [tsubaki-kabelschlepp.com/traxline](http://tsubaki-kabelschlepp.com/traxline)

Subject to change without notice.

	MT series
	XLT series
	ROBOTRAX® System
	FLATVEYOR®
	CLEANVEYOR®
	LS/LSX series
	S/SX series
	S/SX-Tubes series
	Accessories
	TRAXLINE®



## Aluminum stay LG – hole stay, split version

- » Optimum cable routing in the neutral bending line.  
Split version for easy cable routing. Stays also available unsplit.
- » Available customized in **1 mm grid**.
- » **Inside/outside:** Threaded joint easy to release.

**HEAVY DUTY**  
TSUBAKI KABELSCHLEPP



Stay arrangement on every  
2<sup>nd</sup> chain link, **standard**  
(**HS: half-stayed**)



Stay arrangement on each  
chain link (**VS: fully-stayed**)



**1 mm** B<sub>k</sub> 100 – 600 mm  
in **1 mm width sections**

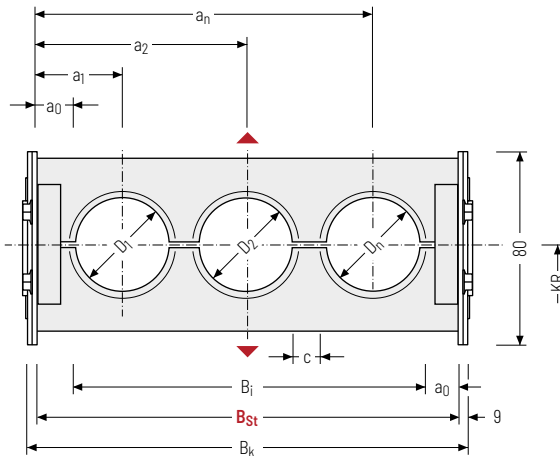

The maximum cable diameter strongly depends on the bending radius and the desired cable type. Please contact us.

### Calculating the cable carrier length

#### Cable carrier length L<sub>k</sub>

$$L_k \approx \frac{L_S}{2} + L_B$$

Cable carrier length L<sub>k</sub>  
rounded to pitch t

### Calculating the stay width

#### Stay width B<sub>St</sub>

$$B_{St} = \sum D + \sum c + 2 a_0$$

D <sub>max</sub> [mm]	D <sub>min</sub> [mm]	h <sub>t</sub> [mm]	B <sub>i</sub> [mm]	B <sub>St</sub> [mm]*	B <sub>k</sub> [mm]	c <sub>min</sub> [mm]	a <sub>0 min</sub> [mm]	KR [mm]					q <sub>k</sub> 50 %** [kg/m]
48	12	80	54	82	B <sub>St</sub> +18	4	14	105	125	155	195	260	4,00
			554	582				295	325	365	430	7,99	

\* in 1 mm width sections \*\* Hole ratio of the hole stay approx. 50 %



**LS1050**

Type

**180**

B<sub>St</sub> [mm]

**LG**

Stay variant

**125**

KR [mm]

**Sb**

Material

**2415**

L<sub>k</sub> [mm]

**HS**

Stay arrangement



Subject to change without notice.

MT  
series

XLT  
series

ROBOTRAX®  
System

FLATVEYOR®

CLEANVEYOR®

LS/LSX  
series

S/SX  
series

S/SX-Tubes  
series

Accessories

TRAXLINE®

## Aluminum stay RMA – mounting frame stay

- » Aluminum profile bars with plastic mounting frame stays for guiding very large cable diameters.
- » The mounting frame stay can be mounted either inside or outside in the bending radius. Available customized in **1 mm width sections**.
- » **Outside/inside:** Screw-fixing easy to release.



Stay arrangement on every 2<sup>nd</sup> chain link, **standard** (HS: half-stayed)



Stay arrangement on each chain link (**VS: fully-stayed**)



**1mm** B<sub>k</sub> 200 – 400 mm in **1 mm width sections**

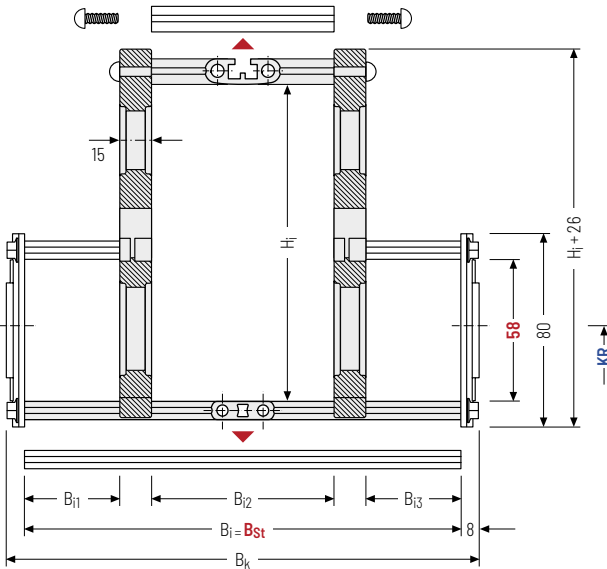

The maximum cable diameter strongly depends on the bending radius and the desired cable type. Please contact us.

### Calculating the cable carrier length

#### Cable carrier length L<sub>k</sub>

$$L_k \approx \frac{L_S}{2} + L_B$$

Cable carrier length L<sub>k</sub> rounded to pitch t



### Intrinsic cable carrier weight

Determining the intrinsic cable carrier weight strongly depends on the selected stay arrangement. Please contact us.

h <sub>i</sub> [mm]	H <sub>i</sub> [mm]	h <sub>G</sub> [mm]	B <sub>i</sub> [mm]	B <sub>i1 min</sub> [mm]	B <sub>i2 min</sub> [mm]	B <sub>i3 min</sub> [mm]	B <sub>St</sub> [mm]*	B <sub>k</sub> [mm]	KR [mm]	
58	130	80	184 - 384	35	84	35	184 - 384	B <sub>St</sub> + 16	105	
	160								125	
	200								155	
									195	
										260
										295
										325
										365
										430

\* in 1 mm width sections

### Order example



**LS1050**  
Type

**280**  
B<sub>St</sub> [mm]

**RMA2**  
Stay variant

**195**  
KR [mm]

**Sb**  
Material

**2415**  
L<sub>k</sub> [mm]

**HS**  
Stay arrangement

## Assembly variants

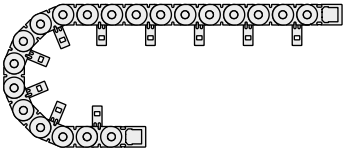

### RMA 1 – assembly to the inside:

Gliding application is not possible when using assembly version RMA 1.

Observe minimum KR:

$H_i = 130 \text{ mm}; KR_{\min} = 195 \text{ mm}$

$H_i = 160 \text{ mm}; KR_{\min} = 260 \text{ mm}$

$H_i = 200 \text{ mm}; KR_{\min} = 260 \text{ mm}$

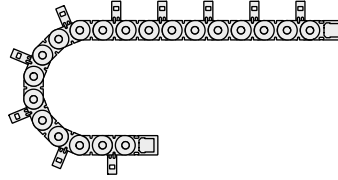

### RMA 2 – assembly to the outside:

The cable carrier has to rest on the side bands and not on the stays.

Guiding in a **channel is required** for support. Please contact our technical support at [technik@kabelschlepp.de](mailto:technik@kabelschlepp.de) to find the corresponding guiding channel.

Please note the operating and installation height.

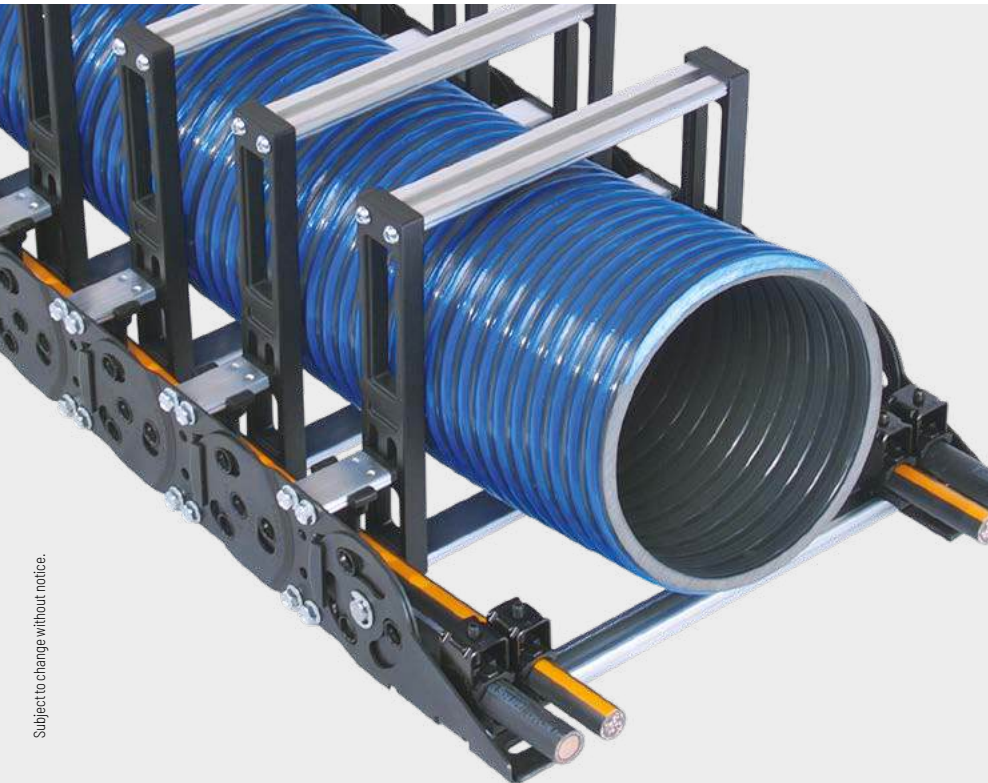

Subject to change without notice.

MT series

XLT series

ROBOTRAX® System

FLATVEYOR®

CLEANVEYOR®

LS/LSX series

S/SX series

S/SX-Tubes series

Accessories

TRAXLINE®



MT  
seriesXLT  
seriesROBOTRAX®  
System

FLATVEYOR®

CLEANVEYOR®

LS/LSX  
seriesS/SX  
seriesS/SX-Tubes  
series

Accessories

TRAXLINE®

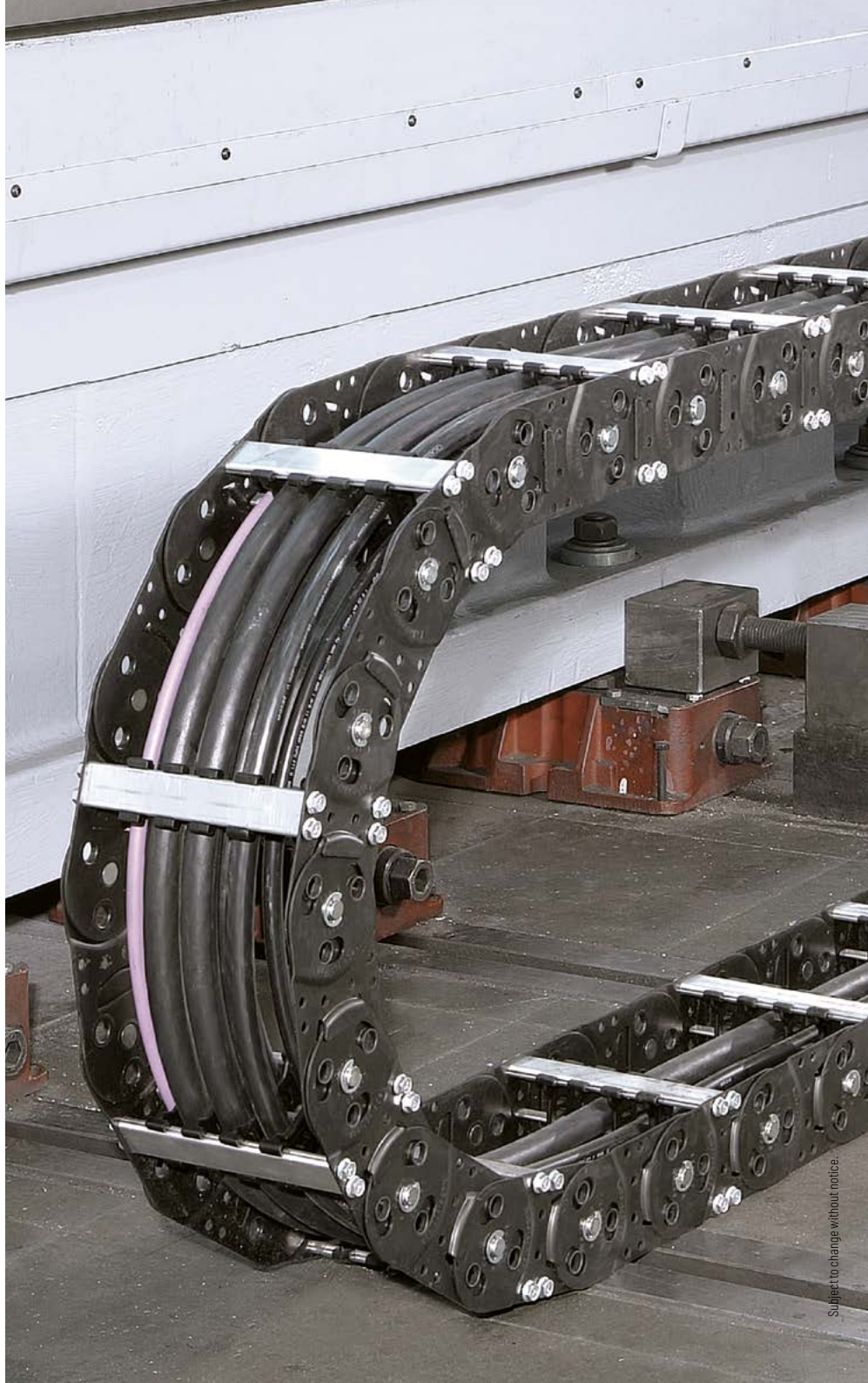

**End connectors - steel**

End connectors made of steel. The connection variants on the fixed point and on the driver can be combined and, if required, changed afterwards.

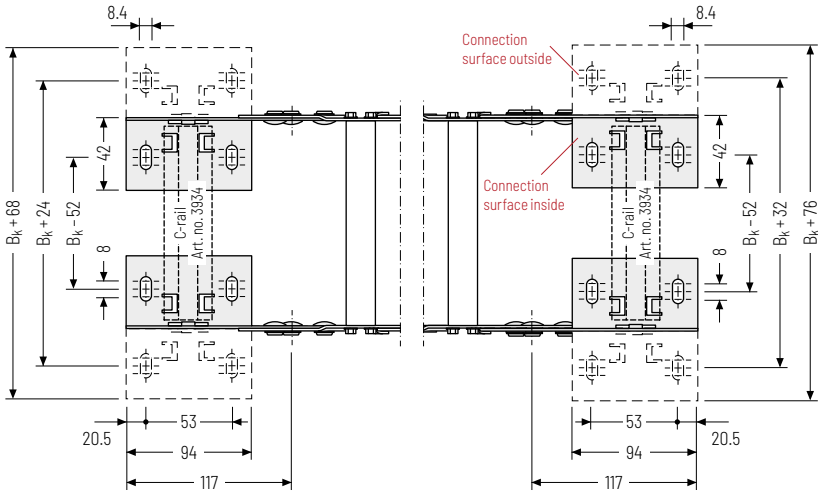
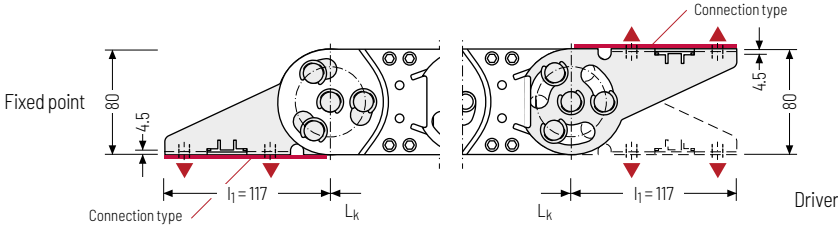

▲ Assembly options

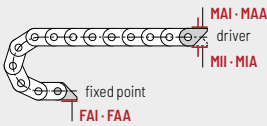

**Connection point**

- F - fixed point
- M - driver

**Connecting surface**

- A - connecting surface outside
- I - connecting surface inside

**Connection type**

- A - threaded joint outside (standard)
- I - threaded joint inside

**Order example**

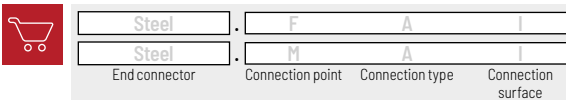

 We recommend the use of strain reliefs before driver and fixed point. See from p. 904.

MT series
XLT series
ROBOTRAX® System
FLATVEYOR®
CLEANVEYOR®
<b>LS/LSX series</b>
S/SX series
S/SX-Tubes series
Accessories
TRAXLINE®