

M series

Variable cable carrier
with extensive accessories
and stay variants



Trademarks are legally protected for the TSUBAKI KABELSCHLEPP GmbH as a national or international registration in the following countries: tsubaki-kabelschlepp.com/trademarks

Subject to change without notice

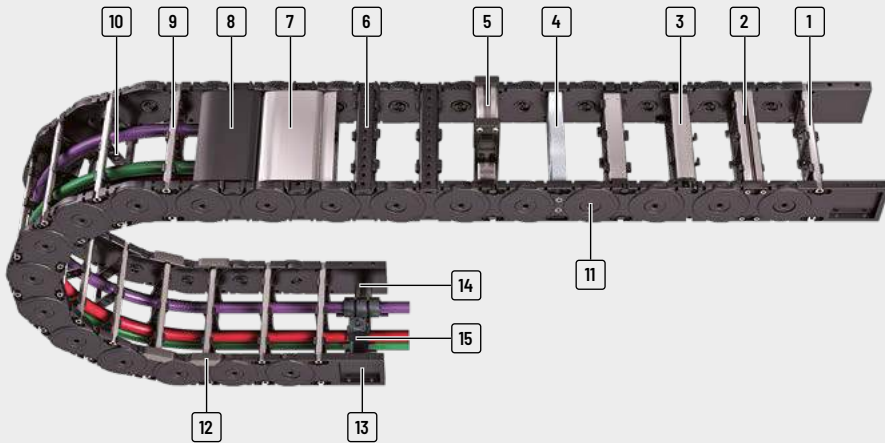

- | | | | |
|--|--|---|--|
| <p>1 Aluminum stays available in 1 mm width sections</p> <p>2 4-fold bolted aluminum stays for extreme loads</p> <p>3 Aluminum stays with ball joint</p> <p>4 Aluminum hole stays</p> | <p>5 Mounting frame stays</p> <p>6 Plastic stays available in 4, 8 or 16 mm width sections</p> <p>7 Aluminum cover available in 1 mm width sections</p> | <p>8 Plastic cover available in 8 or 16 mm width sections</p> <p>9 Can be opened quickly on the inside and the outside for cable laying</p> <p>10 Fixable dividers</p> <p>11 Locking bolts</p> | <p>12 Replaceable glide shoes</p> <p>13 Universal end connectors (UMB)</p> <p>14 C-rail for strain relief elements</p> <p>15 Strain relief combs</p> |
|--|--|---|--|

Features

- » Encapsulated, dirt-resistant stroke system
- » Durable sidebands through robust link plate design
- » Easy assembly of side bands through bars with easy-to-assemble locking bolts
- » Long service life due to minimized hinge wear owing to the "life extending 2 disc principle"
- » Large selection of vertical and horizontal stay systems and dividing options for your cables
- » Versions with aluminum stays in 1 mm width sections up to 800 mm inner width
- » Versions with plastic stays available in 4, 8 or 16 mm width sections

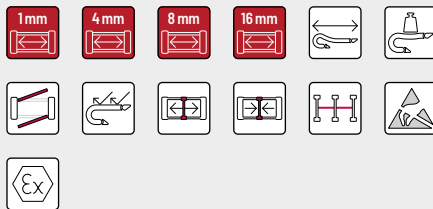

Minimized hinge wear owing to the "life extending 2 disc principle"



Sturdy link plate design, encapsulated stroke system



Easy to assemble through locking bolts



Replaceable glide shoes for long service life for gliding applications

PROTUM®
series

K
series

UNIFLEX
Advanced
series

M
series

XL
series

QUANTUM®
series

TKR
series

TKA
series

UAT
series

Type	Opening variant	Stay variant	h_i	h_G	B_i	B_k	B_i - grid	t	KR	Additional load \leq [kg/m]	Cable- d_{max} [mm]
			[mm]	[mm]	[mm]	[mm]	[mm]	[mm]	[mm]		
PROTUM® series											
M0320											
		RS 01	19	27.5	25 - 280	36 - 291	1	32	37 - 200	2.5	15
		RS 02	19	27.5	25 - 280	36 - 291	1	32	37 - 200	2.5	15
		RE	19	27.5	25 - 189	36 - 200	4	32	37 - 200	2.5	15
UNIFLEX Advanced series											
M0475											
		RD 01	28	39	24 - 280	41 - 297	8	47.5	55 - 300	3.0	22
		RD 02	28	39	24 - 280	41 - 297	8	47.5	55 - 300	3.0	22
M series											
M0650											
		RS	38	57	75 - 400	109 - 434	1	65	75 - 350	25	30
		LG	36	57	75 - 600	109 - 634	1	65	75 - 350	25	29
		RMA	38 (200)	57 (224)	200 - 400	234 - 434	1	65	75 - 350	25	30 (160)
		RE	42	57	50 - 266	84 - 300	8	65	75 - 350	25	33
		RD	42	57	50 - 266	84 - 300	8	65	75 - 350	25	33
QUANTUM® series											
M0950											
		RS	58	80	75 - 400	114 - 439	1	95	140 - 380	35	46
		RV	58	80	75 - 500	114 - 539	1	95	140 - 380	35	46
		RM	54	80	75 - 600	114 - 639	1	95	140 - 380	35	43
		LG	50	80	75 - 600	114 - 639	1	95	140 - 380	35	38
		RMA	58 (200)	80 (224)	200 - 500	239 - 539	1	95	140 - 380	35	46 (160)
		RMR	51	80	75 - 600	114 - 639	1	95	140 - 380	35	46
		RE	58	80	45 - 557	84 - 596	16	95	140 - 380	35	46
		RD	58	80	45 - 557	84 - 596	16	95	140 - 380	35	46
	TKR series										
TKA series											
UAT series											

Unsupported arrangement			Gliding arrangement			Inner Distribution				Movement			Page
Travel length ≤ [m]	$v_{max} \leq [m/s]$	$a_{max} \leq [m/s^2]$	Travel length ≤ [m]	$v_{max} \leq [m/s]$	$a_{max} \leq [m/s^2]$	TS0	TS1	TS2	TS3	vertical hanging or standing	lying on the side	rotating arrangement	
2.8	10	50	80	2.5	25	•	•	-	-	•	•	•	358
2.8	10	50	80	2.5	25	•	•	-	-	•	•	•	358
2.8	10	50	80	2.5	25	•	•	-	-	•	•	•	360
2.7	10	50	-	-	-	•	•	•	-	•	•	•	366
2.7	10	50	-	-	-	•	•	•	-	•	•	•	368
4.8	10	40	220	8	20	•	•	•	•	•	•	•	374
4.8	10	40	220	8	20	-	-	-	-	•	•	•	378
4.8	10	40	220	8	20	•	-	-	-	•	•	-	380
4.8	10	40	220	8	20	•	•	-	•	•	•	•	382
4.8	10	40	220	8	20	•	•	-	•	•	•	•	383
7.4	10	30	260	8	20	•	•	•	•	•	•	•	392
7.4	10	30	260	8	20	•	•	•	•	•	-	•	396
7.4	10	30	260	8	20	•	•	•	-	•	•	•	400
7.4	10	30	260	8	20	-	-	-	-	•	•	•	402
7.4	10	30	260	8	20	•	-	-	-	•	•	-	404
7.4	10	30	260	8	20	•	-	-	-	•	•	•	406
7.4	10	30	260	8	20	•	•	•	•	•	•	•	408
7.4	10	30	260	8	20	•	•	•	•	•	•	•	409

PROTUM® series

K series

UNIFLEX Advanced series

M series

XL series

QUANTUM® series

TKR series

TKA series

UAT series

Type	Opening variant	Stay variant	h_i [mm]	h_G [mm]	B_i [mm]	B_k [mm]	B_i - grid [mm]	t [mm]	KR [mm]	Additional load ≤ [kg/m]	Cable- d_{max} [mm]
M1250											
K series		RS	72	96	75 - 400	120 - 445	1	125	180 - 500	65	61
		RV	72	96	100 - 600	145 - 645	1	125	180 - 500	65	61
UNIFLEX Advanced series		RM	69	96	100 - 800	145 - 845	1	125	180 - 500	65	59
		LG	76	96	100 - 800	145 - 845	1	125	180 - 500	65	59
M series		RMA	72 (200)	96 (226)	200 - 800	245 - 845	1	125	180 - 500	65	61 (160)
		RMR	66	96	100 - 800	145 - 845	1	125	180 - 500	65	54
		RE	72	96	71 - 551	116 - 596	16	125	180 - 500	65	61
		RD	72	96	71 - 551	116 - 596	16	125	180 - 500	65	61
	M1300										
XL series		RMF	87	120	100 - 800	150 - 850	1	130	150 - 500	70	75
		RMS	87	120	100 - 800	150 - 850	1	130	150 - 500	70	75
		LG	98	120	100 - 800	150 - 850	1	130	150 - 500	70	74

* Further information on request.

Unsupported arrangement			Gliding arrangement			Inner Distribution				Movement			Page
Travel length ≤ [m]	v_{max} ≤ [m/s]	a_{max} ≤ [m/s ²]	Travel length ≤ [m]	v_{max} ≤ [m/s]	a_{max} ≤ [m/s ²]	TS0	TS1	TS2	TS3	vertical hanging or standing	lying on the side	rotating arrangement	
9.7	10	25	320	8	20	•	•	-	•	•	•	•	418
9.7	10	25	320	8	20	•	•	•	•	•	-	•	422
9.7	10	25	320	8	20	•	•	•	-	•	•	•	426
9.7	10	25	320	8	20	-	-	-	-	•	•	•	428
9.7	10	25	320	8	20	•	-	-	-	•	•	-	430
9.7	10	25	320	8	20	•	-	-	-	•	•	•	432
9.7	10	25	320	8	20	•	•	•	•	•	•	•	434
9.7	10	25	320	8	20	•	•	•	•	•	•	•	435
10.8	10	25	350	8	20	•	•	-	•	-	-	-	442
10.8	10	25	350	8	20	•	•	-	•	•	•	•	444
10.8	10	25	350	8	20	-	-	-	-	•	•	•	446

PROTUM® series

K series

UNIFLEX Advanced series

M series

XL series

QUANTUM® series

TKR series

TKA series

UAT series

M0320



Pitch
32 mm



Inner height
19 mm



Inner widths
25 – 280 mm



Bending radii
37 – 200 mm

Stay variants



Aluminum stay 01..... page 358

Frame stay detachable inside

- » Aluminum profile bars for light to medium loads.
Assembly without screws.
- » **Inside:** release by turning by 90°.



Aluminum stay 02..... page 358

Frame stay detachable outside "the standard"

- » Aluminum profile bars for light to medium loads.
Assembly without screws.
- » **Outside:** release by turning by 90°.



Plastic stay RE..... page 360

Frame screw-in stay

- » Plastic profile bars for light to medium loads.
Assembly without screws.
- » **Inside/outside:** release by turning by 90°.

More product information online



Assembly instructions etc.:
Additional info via your
smartphone or check online at
[tsubaki-kabelschlepp.com/
downloads](http://tsubaki-kabelschlepp.com/downloads)



Configure your custom
cable carrier here:
online-engineer.de

Unsupported arrangement

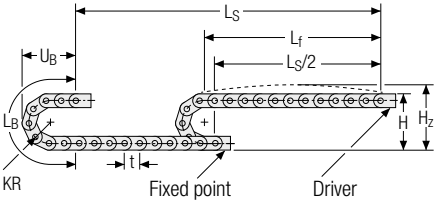





KR [mm]	H [mm]	H _z [mm]	L _B [mm]	U _B [mm]
37	101.5	121.5	181	83
47	121.5	141.5	212	93
77	181.5	201.5	306	123
100	227.5	247.5	379	146
200	427.5	427.5	693	246

Load diagram for unsupported length depending on the additional load.

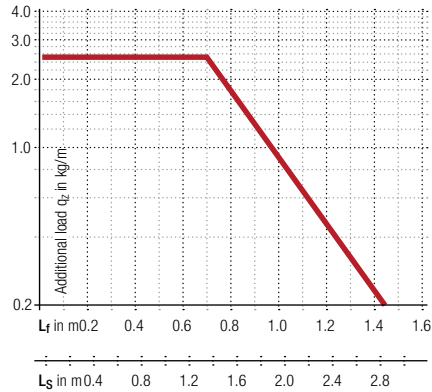
Sagging of the cable carrier is technically permitted for extended travel lengths, depending on the specific application.





Intrinsic cable carrier weight $q_k = 0.54 \text{ kg/m}$. For other inner widths, the maximum additional load changes.

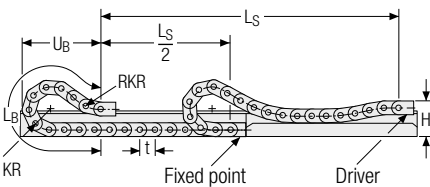

-  **Speed**
up to 10 m/s
-  **Acceleration**
up to 50 m/s²
-  **Travel length**
up to 2.8 m
-  **Additional load**
up to 2.5 kg/m

Gliding arrangement



-  **Speed**
up to 2.5 m/s
 -  **Acceleration**
up to 25 m/s²
 -  **Travel length**
up to 80 m
 -  **Additional load**
up to 2.5 kg/m
-  The gliding cable carrier must be guided in a channel. See p. 844.

 Our technical support can provide help for gliding arrangements:
technik@kabelschlepp.de

PROTUM® series
K series
UNIFLEX Advanced series
M series
XL series
QUANTUM® series
TKR series
TKA series
UAT series

Aluminum stay 01/02 – frame stay detachable outside

- Extremely quick to open and close
- Aluminum profile bars for light to medium loads.
Assembly without screws.
- Available customized in **1 mm grid**.
- **Outside/inside:** release by turning by 90°.

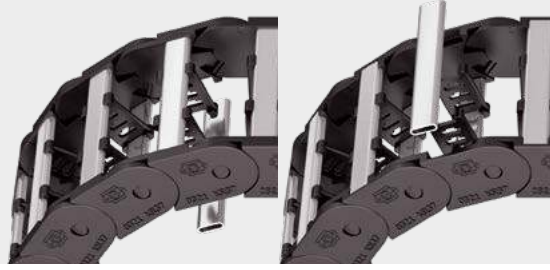

Stay arrangement on each chain link (**VS: fully-stayed**)



1 mm B_i 25 – 280 mm
in 1 mm width sections

Aluminum stay 01 frame stay detachable inside

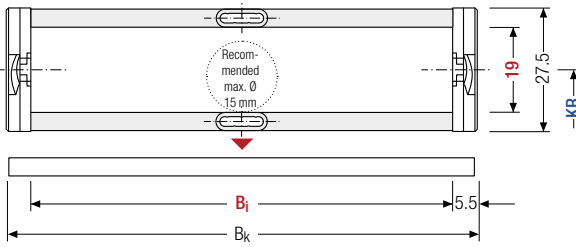

Aluminum stay 02 frame stay detachable outside

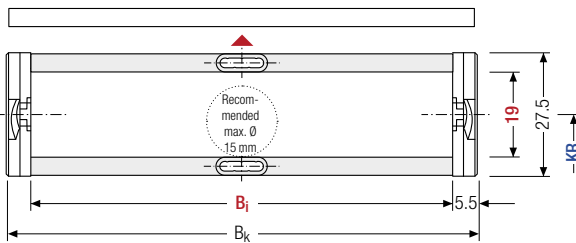

The maximum cable diameter strongly depends on the bending radius and the desired cable type. Please contact us.

Calculating the cable carrier length

Cable carrier length L_k

$$L_k \approx \frac{L_S}{2} + L_B$$

Cable carrier length L_k
rounded to pitch t

h_i [mm]	h_G [mm]	B_i [mm]*	B_k [mm]	KR [mm]			q_k [kg/m]		
19	27.5	25 – 280	$B_i + 11$	37	47	77	100	200	0.47 – 1.70

* in 1 mm width sections

Order example



MC0320

Type

200

B_i [mm]

01

Stay variant

100

KR [mm]

1152

L_k [mm]

VS

Stay arrangement

Divider systems

As a standard, the divider system is mounted on each crossbar – for stay mounting on every 2nd chain link (HS).

As a standard, dividers and the complete divider system (dividers with height separations) can be moved in the cross section (**version A**).

Divider system TSO without height separation

Vers.	a _T min [mm]	a _x min [mm]	a _c min [mm]	n _T min
A	3	6	4	2

The dividers can be moved in the cross section.

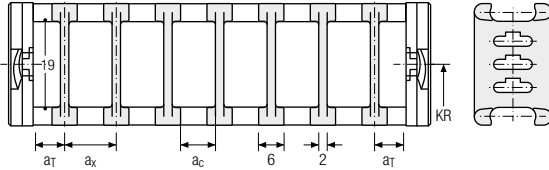

Divider system TS1 with continuous height separation

Vers.	a _T min [mm]	a _T max [mm]	a _x min [mm]	a _c min [mm]	n _T min
A	3	20	6	4	2

The dividers can be moved in the cross section.

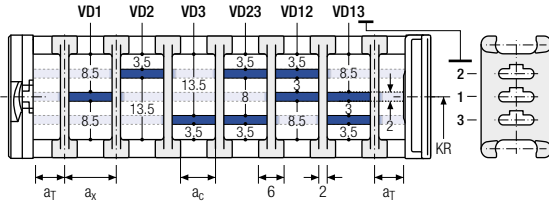

Order example

TS1

A

3

VD1

-

VD3

⋮

VD3

-

VD3

Divider system

Version

n_T

Height separation

Please state the designation of the divider system (**TS0, TS1 ...**), version and number of dividers per cross section [n_T].

If using divider systems with height separation (**TS1**) please also state the positions [e.g. VD1] viewed from the left driver belt. You are welcome to add a sketch to your order.

PROTUM® series
K series
UNIFLEX Advanced series
M series
XL series
QUANTUM® series
TKR series
TKA series
UAT series

Plastic stay RE – screw-in frame stay

- Plastic profile bars for light to medium loads.
Assembly without screws.
- Available customized in **4 mm grid**.
- **Outside/inside:** release by turning by 90°.



Stay arrangement on each chain link (**VS: fully-stayed**)



4 mm B_i 25 – 189 mm
in 4 mm width sections

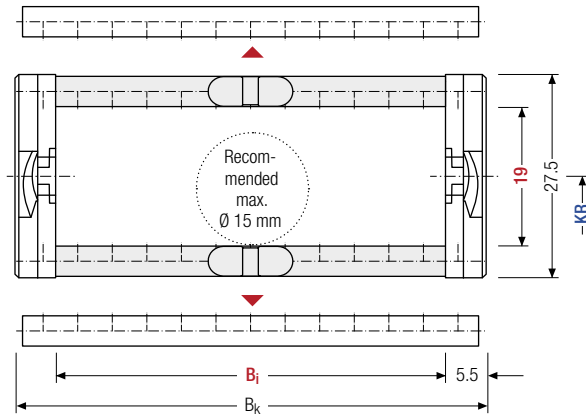

The maximum cable diameter strongly depends on the bending radius and the desired cable type. Please contact us.

Calculating the cable carrier length

Cable carrier length L_k

$$L_k \approx \frac{L_s}{2} + L_B$$

Cable carrier length L_k
rounded to pitch t

h _i [mm]	h _g [mm]	B _i [mm]										B _k [mm]	KR [mm]	q _k [kg/m]		
19	27.5	25	29	33	37	41	45	49	53	57	61	65	B _i + 11	37	47	0.46
		69	73	77	81	85	89	93	97	101	105	109		77	100	
		113	117	121	125	129	133	137	141	145	149	200		1.00		



For B_i > 149 mm we recommend a multi-band chain.

Order example



ME0320

Type

105

B_i [mm]

RE

Stay variant

100

KR [mm]

1152

L_k [mm]

VS

Stay arrangement

Divider systems

As a standard, the divider system is mounted on each crossbar – for stay mounting on every 2nd chain link (HS).

As a standard, dividers and the complete divider system (dividers with height separations) can be moved in the cross section (**version A**).

The dividers are easily attached to the stay for applications with lateral acceleration and for applications laying on their side by simply turning the frame stay by 180°. The arresting cams click into place in the locking grids in the crossbars (**version B**). The groove in the frame stay faces outwards.

Divider system TSO without height separation

Vers.	a _T min [mm]	a _x min [mm]	a _c min [mm]	a _x grid [mm]	n _T min
A	3	6	4	–	–
B	4.5	8	6	4	–

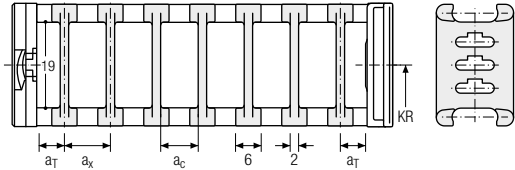

The dividers can be moved in the cross section.

Divider system TS1 with continuous height separation

Vers.	a _T min [mm]	a _T max [mm]	a _x min [mm]	a _c min [mm]	a _x grid [mm]	n _T min
A	3	20	6	4	–	2
B	4.5	20.5	8	6	4	2

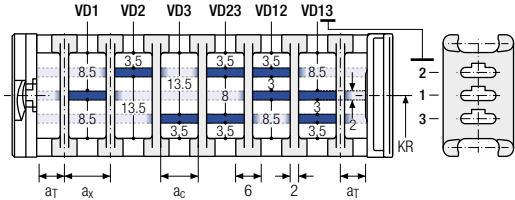

The dividers can be moved in the cross section.

Order example

TS1

A

3

VD1

-

VD1

⋮

VD3

-

VD3

Divider system
Version
n_T
Height separation

Please state the designation of the divider system (**TS0, TS1 ...**), version and number of dividers per cross section [n_T].

If using divider systems with height separation (**TS1**), please also state the positions [e.g. VD1] viewed from the left driver belt. You are welcome to add a sketch to your order.

PROTUM® series
K series
UNIFLEX Advanced series
M series
XL series
QUANTUM® series
TKR series
TKA series
UAT series

PROTUM®
seriesK
seriesUNIFLEX
Advanced
seriesM
seriesXL
seriesQUANTUM®
seriesTKR
seriesTKA
seriesUAT
series

One part end connectors – plastic/aluminum (with integrated strain relief)

The plastic/aluminum end connectors can be **connected from above or below**. The connection variants on the fixed point and on the driver can be combined and, if required, changed afterwards.

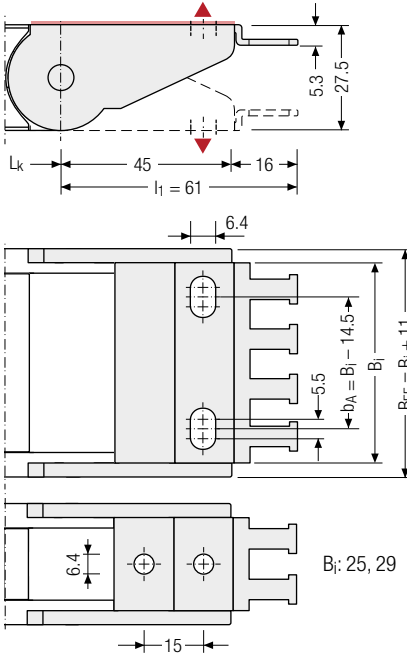

One-part end connectors – plastic/aluminum

The plastic/aluminum end connectors can be **connected from above or below**. The connection variants on the fixed point and on the driver can be combined and, if required, changed afterwards.

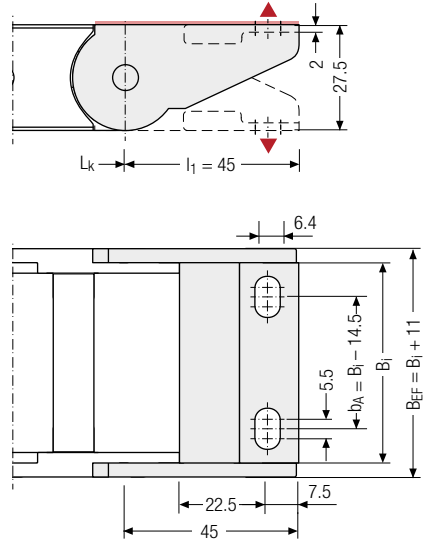

▲ Assembly options

B_i [mm]	n_z	B_i [mm]	n_z	B_i [mm]	n_z	B_i [mm]	n_z
25	2	39	4	89	7	149	11
29	2	49	4	109	8		
37	3	69	5	124	10		

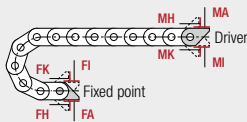

Connection point

F – fixed point
M – driver

Connection type

A – threaded joint outside (standard)
I – threaded joint inside
H – threaded joint, rotated 90° to the outside
K – threaded joint, rotated 90° to the inside

Order example



Plastic/aluminum

F A

Plastic/aluminum

M A

End connector

Connection point

Connection type



We recommend the use of strain reliefs at the driver and fixed point. See from p. 904.



Subject to change without notice.

PROTUM®
series

K
series

UNIFLEX
Advanced
series

M
series

XL
series

QUANTUM®
series

TKR
series

TKA
series

UAT
series

M0475



Pitch
47.5 mm



Inner height
28 mm



Inner widths
24 - 280 mm



Bending radii
55 - 300 mm

Stay variants



Plastic stay RD 01 page 366

Frame stay with hinge in the inner radius

- » Plastic profile bars with hinge for light to medium loads.
Assembly without screws.
- » **Outside:** release by turning by 90°.
- » **Inside:** swivable to both sides.



Plastic stay RD 02 page 368

Frame stay with hinge in the outer radius

- » Plastic profile bars with hinge for light to medium loads.
Assembly without screws.
- » **Outside:** swivable to both sides.
- » **Inside:** release by turning by 90°.



MT series

Also available as covered variants with cover system.
More information can be found
in chapter "MT series" from p. 612.

More product information online



Assembly instructions etc.:
Additional info via your smartphone
or check online at
[tsubaki-kabelschlepp.com/
downloads](http://tsubaki-kabelschlepp.com/downloads)



Configure your custom
cable carrier here:
online-engineer.de

Unsupported arrangement

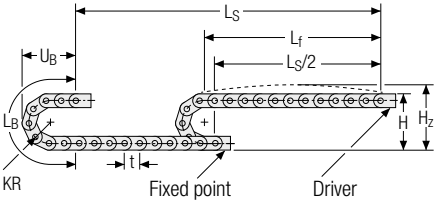

KR [mm]	H [mm]	H _z [mm]	L _B [mm]	U _B [mm]
55	149	174	268	122
75	189	214	331	142
100	239	264	410	167
130	299	324	504	197
160	359	384	598	227
200	439	464	724	267
250	539	564	881	317
300	639	664	1038	367

Load diagram for unsupported length depending on the additional load.

Sagging of the cable carrier is technically permitted for extended travel lengths, depending on the specific application.

Intrinsic cable carrier weight $q_k = 1.7 \text{ kg/m}$. For other inner widths, the maximum additional load changes.

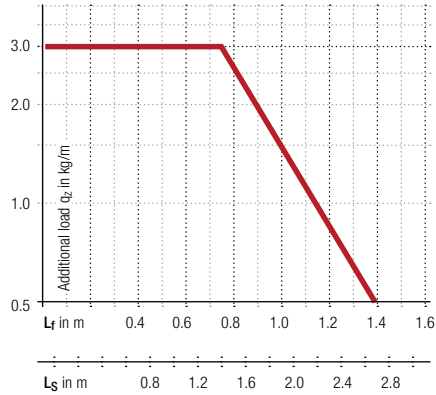

Speed
up to 10 m/s

Acceleration
up to 50 m/s²

Travel length
up to 2.7 m

Additional load
up to 3.0 kg/m

PROTUM® series
K series
UNIFLEX Advanced series
M series
XL series
QUANTUM® series
TKR series
TKA series
UAT series

Plastic stay RD 01 – frame stay with hinge in the inner radius

- Plastic profile bars with hinge for light to medium loads. Assembly without screws.
- Available customized in **8 mm grid**.
- **Outside:** release by turning by 90°.
Inside: swivable to both sides.



Stay arrangement on every chain link (**VS: fully-stayed**)



8 mm B_i 24 – 280 mm
in 8 mm width sections

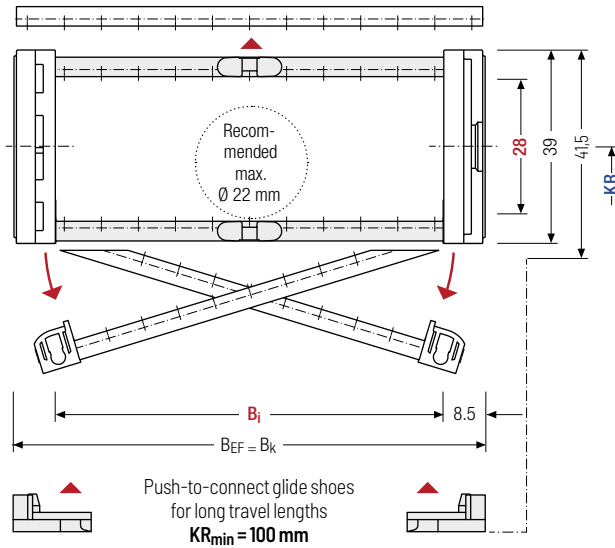

The maximum cable diameter strongly depends on the bending radius and the desired cable type. Please contact us.

Calculating the cable carrier length

Cable carrier length L_k

$$L_k \approx \frac{L_S}{2} + L_B$$

Cable carrier length L_k rounded to pitch t

h_i [mm]	h_g [mm]	B_i [mm]										B_k [mm]	B_{EF} [mm]	KR [mm]	q_k [kg/m]		
28	39	24	32	40	48	56	64	72	80	88	$B_i + 17$	$B_i + 17$	55	75	0.79		
		96	104	112	120	128	136	144	152	160			100	130		-	
		168	176	184	192	200	208	216	224	232			160	200			3.03
		240	248	256	264	272	280	250	300								

Order example



MK0475

Type

128

B_i [mm]

RD 01

Stay variant

100

KR [mm]

1425

L_k [mm]

VS

Stay arrangement

Divider systems

As a standard, the divider system is mounted on each crossbar – for stay mounting on every 2nd chain link (HS).

As a standard, dividers and the complete divider system (dividers with height separations) can be moved in the cross section (**version A**).

The dividers are easily attached to the stay for applications with lateral acceleration and for applications laying on their side by simply turning the frame stay by 180°. The arresting cams click into place in the locking grids in the crossbars (**version B**). The groove in the frame stay faces outwards.

Divider system TSO without height separation

Vers.	a _T min [mm]	a _x min [mm]	a _c min [mm]	a _x grid [mm]	n _T min
A	6	7.8	5	–	–
B	12	8	5.2	8	–

The dividers can be moved within the cross section (version A) or fixed (version B).

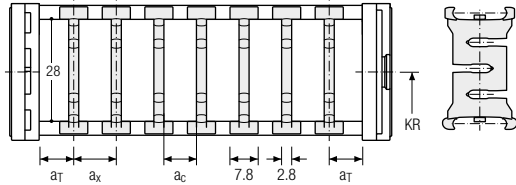

Divider system TS1 with continuous height separation

Vers.	a _T min [mm]	a _T max [mm]	a _x min [mm]	a _c min [mm]	a _x grid [mm]	n _T min
A	6	20	7.8	5	–	2
B	12	20	8	5.2	8	2

The dividers can be moved within the cross section (version A) or fixed (version B).

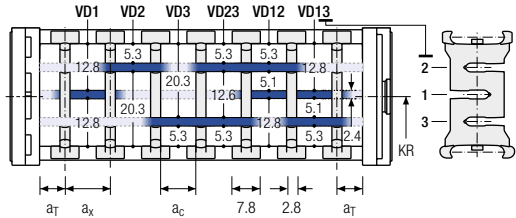

Divider system TS2 with partial height separation

Vers.	a _T min [mm]	a _x min [mm]	a _c min [mm]	a _x grid [mm]	n _T min
B	12	8*/24	5.2*/21.2	8	2

* for VR0

With grid distribution (8 mm grid). The dividers are fixed by the height separation, the complete divider system is movable in the cross section (version A) or fixed (version B).

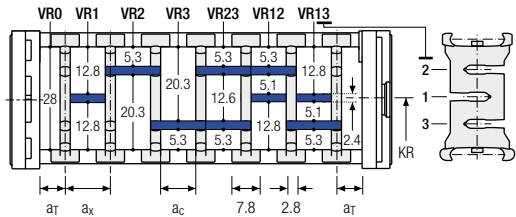

Order example

TS2

A

3

K1

34

VR1

⋮

⋮

⋮

K4

38

VR3

Divider system

Version

n_T

Chamber

a_x

Height separation

PROTUM® series
K series
UNIFLEX Advanced series
M series
XL series
QUANTUM® series
TKR series
TKA series
UAT series

Plastic stay RD 02 – frame stay with hinge in the outer radius

- Plastic profile bars with hinge for light to medium loads. Assembly without screws.
- Available customized in **8 mm grid**.
- **Outside:** swivable to both sides.
Inside: release by turning by 90°.



Stay arrangement on every chain link (**VS: fully-stayed**)



8 mm B_i 24 – 280 mm
in **8 mm** width sections

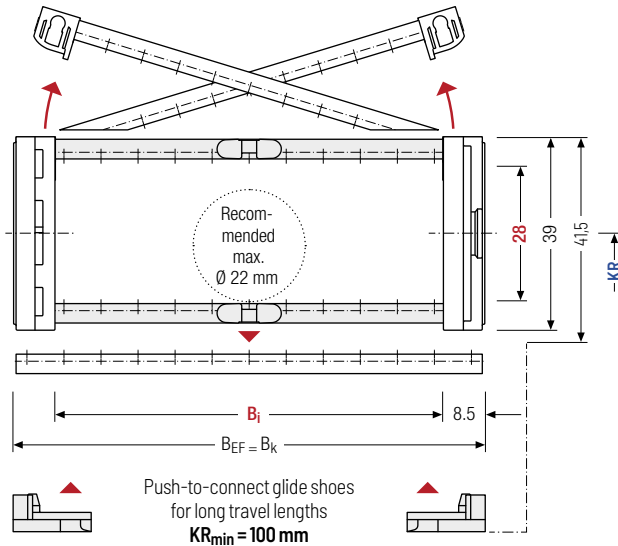

The maximum cable diameter strongly depends on the bending radius and the desired cable type. Please contact us.

Calculating the cable carrier length

Cable carrier length L_k

$$L_k \approx \frac{L_S}{2} + L_B$$

Cable carrier length L_k rounded to pitch t

h_i [mm]	h_g [mm]	B_i [mm]										B_k [mm]	B_{EF} [mm]	KR [mm]	q_k [kg/m]	
28	39	24	32	40	48	56	64	72	80	88	$B_i + 17$	$B_i + 17$	55	75	0.79	
		96	104	112	120	128	136	144	152	160			100	130		
		168	176	184	192	200	208	216	224	232			160	200		–
		240	248	256	264	272	280	250	300	3.03						

Order example



MK0475

Type

128

B_i [mm]

RD 02

Stay variant

100

KR [mm]

1425

L_k [mm]

VS

Stay arrangement

Divider systems

As a standard, the divider system is mounted on each crossbar – for stay mounting on every 2nd chain link (HS).

As a standard, dividers and the complete divider system (dividers with height separations) can be moved in the cross section (**version A**).

The dividers are easily attached to the stay for applications with lateral acceleration and for applications laying on their side by simply turning the frame stay by 180°. The arresting cams click into place in the locking grids in the crossbars (**version B**). The groove in the frame stay faces outwards.

Divider system TSO without height separation

Vers.	a _T min [mm]	a _x min [mm]	a _c min [mm]	a _x grid [mm]	n _T min
A	6	7.8	5	–	–
B	12	8	5.2	8	–

The dividers can be moved within the cross section (version A) or fixed (version B).

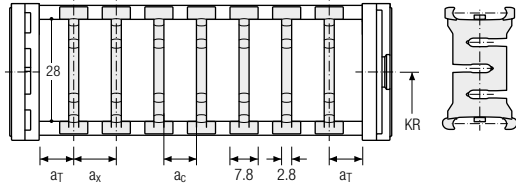

Divider system TS1 with continuous height separation

Vers.	a _T min [mm]	a _T max [mm]	a _x min [mm]	a _c min [mm]	a _x grid [mm]	n _T min
A	6	20	7.8	5	–	2
B	12	20	8	5.2	8	2

The dividers can be moved within the cross section (version A) or fixed (version B).

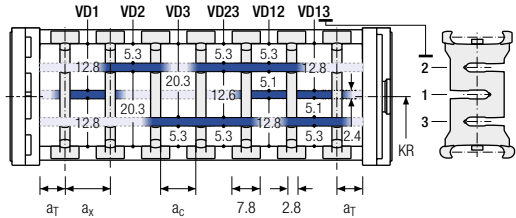

Divider system TS2 with partial height separation

Vers.	a _T min [mm]	a _x min [mm]	a _c min [mm]	a _x grid [mm]	n _T min
B	12	8*/24	5.2*/21.2	8	2

* for VR0

With grid distribution (8 mm grid). The dividers are fixed by the height separation, the complete divider system is movable in the cross section (version A) or fixed (version B).

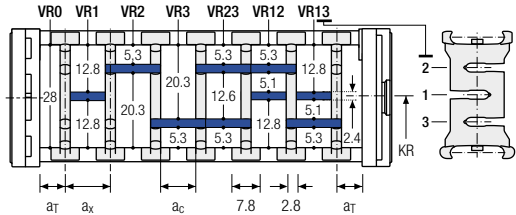

Order example

TS2

A

3

K1

34

VR1

⋮

⋮

⋮

K4

38

VR3

Divider system

Version

n_T

Chamber

a_x

Height separation

PROTUM® series
K series
UNIFLEX Advanced series
M series
XL series
QUANTUM® series
TKR series
TKA series
UAT series

End connectors – plastic/steel (with strain relief)

Link end connector made of plastic, end connector made of sheet steel with screw-fixed aluminum strain relief. The connection variants on the fixed point and on the driver can be combined and, if required, changed afterwards.

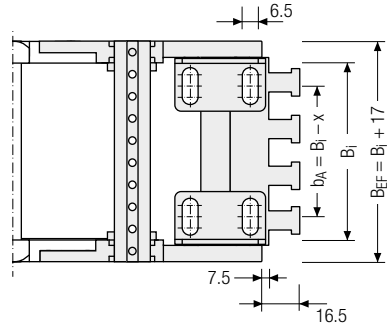
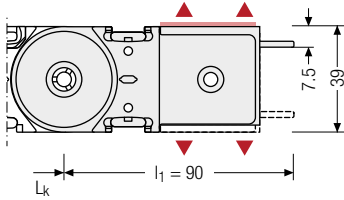

▲ Assembly options

B_i [mm]	x [mm]	n_z
40	17.5	3
56	21.5	4
80	17.5	6
104	19.0	8
128	19.5	9
152	17.5	11
192	18.5	14

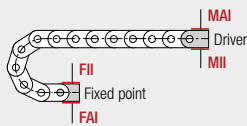

Connection point

F – fixed point
M – driver

Connection surface

I – connection surface inside

Connection type

A – threaded joint outside (standard)
I – threaded joint inside

Order example



Plastic/steel	F	A	I
Plastic/steel	M	A	I
End connector	Connection point	Connection type	Connection surface

End connectors – plastic/steel

Plastic link end connector, steel end connector. The connection variants on the fixed point and on the driver can be combined and, if required, changed afterwards.

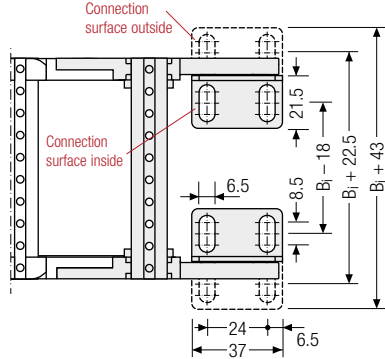
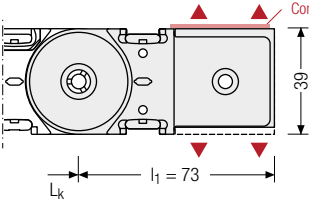

▲ Assembly options

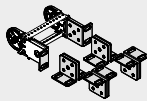
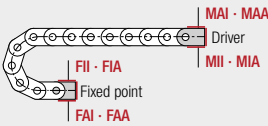

Connection point

- F – fixed point
- M – driver

Connection surface

- I – connection surface inside
- A – connection surface outside

Connection type

- A – threaded joint outside (standard)
- I – threaded joint inside
- F – flange connection

Order example

	Plastic/steel	F	A	A
	Plastic/steel	M	U	
	End connector	Connection point	Connection type	Connection surface



We recommend the use of strain reliefs at the driver and fixed point. See from p. 904.

PROTUM® series
K series
UNIFLEX Advanced series
M series
XL series
QUANTUM® series
TKR series
TKA series
UAT series

M0650

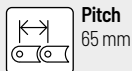

Pitch
65 mm



Inner heights
36 - 42 mm



Inner widths
50 - 600 mm

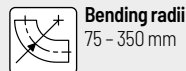

Bending radii
75 - 350 mm

Stay variants



Aluminum stay RS page **374**

Frame stay, narrow "The standard"

- » Aluminum profile bars for light to medium loads.
Assembly without screws.
- » **Outside/inside:** release by turning by 90°.

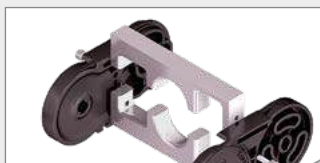

Aluminum stay LG page **378**

Hole stay, split version

- » Optimum cable routing in the neutral bending line.
Split version for easy cable routing. Stays also available unsplit.
- » **Outside/inside:** Screw-fixing easy to release.



Aluminum stay RMA page **380**

Mounting frame stay

- » Aluminum profile bars with plastic mounting frame stays for guiding very large cable diameters.
- » **Outside/inside:** Screw-fixing easy to release.



Plastic stay RE page **382**

Frame screw-in stay

- » Plastic profile bars for light to medium loads. Assembly without screws.
- » **Outside/inside:** release by turning by 90°.



Plastic stay RD page **383**

Frame stay with hinge

- » Plastic profile bars with hinge for light to medium loads.
Assembly without screws.
- » **Outside:** swivable to both sides.
- » **Inside:** release by turning by 90°.



Also available as covered variants with cover system.
More information can be found in chapter "MT series" from p. 612.

Unsupported arrangement

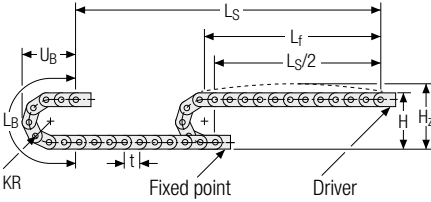





KR [mm]	H [mm]	H _z [mm]	L _B [mm]	U _B [mm]
75	207	242	366	169
95	247	282	429	189
115	287	322	492	209
145	347	382	586	239
175	407	442	680	269
220	497	532	822	314
260	577	612	948	354
275	607	642	994	369
300	657	692	1073	394
350	757	792	1230	444

Load diagram for unsupported length depending on the additional load.

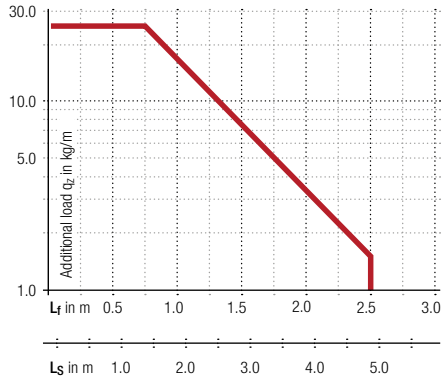
Sagging of the cable carrier is technically permitted for extended travel lengths, depending on the specific application.

Intrinsic cable carrier weight $q_k = 2.4 \text{ kg/m}$. For other inner widths, the maximum additional load changes.





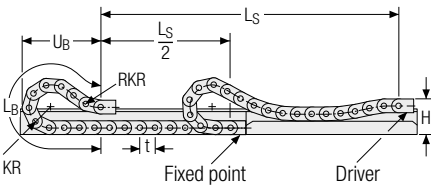

-  **Speed**
up to 10 m/s
-  **Acceleration**
up to 40 m/s²
-  **Travel length**
up to 4.8 m
-  **Additional load**
up to 25 kg/m

Gliding arrangement | GO module with chain links optimized for gliding



KR [mm]	H [mm]	GO module RKR [mm]	L _B [mm]	U _B [mm]
95	171	300	1180	560
115	171	300	1310	605
145	171	300	1440	640
175	171	300	1635	705
220	171	300	1950	810
260	171	300	2275	926
275	171	300	2405	973
300	171	300	2535	1014
350	171	300	2925	1152

-  **Speed**
up to 8 m/s
-  **Acceleration**
up to 20 m/s²
-  **Travel length**
up to 220 m
-  **Additional load**
up to 25 kg/m

 The gliding cable carrier must be guided in a channel. See p. 844.

The GO module mounted on the driver is a defined sequence of 5 adapted KR/RKR link plates.

Gliding shoes have to be used for gliding applications.

PROTUM® series
K series
UNIFLEX Advanced series
M series
XL series
QUANTUM® series
TKR series
TKA series
UAT series

Aluminum stay RS – frame stay narrow

- Extremely quick to open and close
- Aluminum profile bars for light to medium loads.
Assembly without screws.
- Available customized in **1 mm grid**.
- **Outside/inside:** release by turning by 90°.



Stay arrangement on every
2nd chain link, **standard**
(HS: half-stayed)



Stay arrangement on each
chain link (**VS: fully-stayed**)



1 mm B_i 75 – 400 mm
in **1 mm width sections**

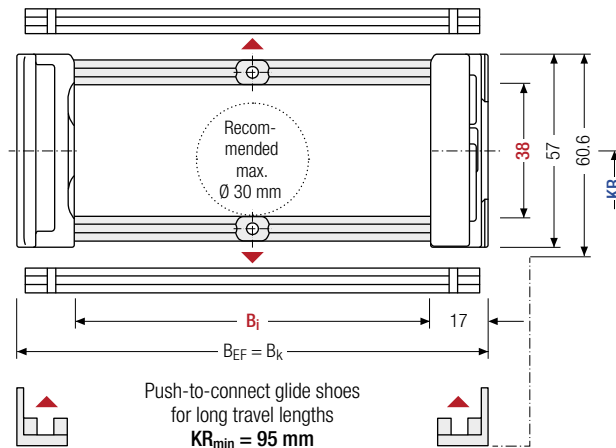

The maximum cable diameter strongly depends on the bending radius and the desired cable type. Please contact us.

For rough environmental conditions, we recommend the use of OFFROAD glide shoes with 80 % higher wear volume.

Calculating the cable carrier length

Cable carrier length L_k

$$L_k \approx \frac{L_s}{2} + L_B$$

Cable carrier length L_k
rounded to pitch t

h_i [mm]	h_G [mm]	$h_{G'}$ [mm]	$h_{G'}$ Offroad [mm]	B_i [mm]*	B_k [mm]	B_{EF} [mm]	KR [mm]			q_k [kg/m]		
38	57	60.6	62.2	75 – 400	$B_i + 34$	$B_i + 34$	75	95	115	145	175	1.98 – 3.85
							220	260	275	300	350	

* in 1 mm width sections

Order example



MC0650

Type

300

B_i [mm]

RS

Stay variant

175

KR [mm]

1430

L_k [mm]

HS

Stay arrangement

Divider systems

As a standard, the divider system is mounted on each crossbar – for stay mounting on every 2nd chain link (HS).
As a standard, dividers and the complete divider system (dividers with height separations) can be moved in the cross section (**version A**).

For applications with lateral acceleration and rotated by 90°, the dividers can be attached by simply clipping on to a socket (available as an accessory).
The bushing additionally serves as a spacer between the dividers and is available in 1 mm sections between 3 – 50 mm. The inner height is reduced to 32 mm (**version B**).

Divider system TSO without height separation

Vers.	a _T min [mm]	a _x min [mm]	a _c min [mm]	n _T min
A	6.5	13	10	2

The dividers can be moved in the cross section.

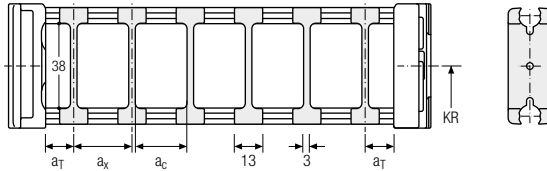

Divider system TS1 with continuous height separation

Vers.	a _T min [mm]	a _T max [mm]	a _x min [mm]	a _c min [mm]	n _T min
A	6.5	25	13	10	2

The dividers can be moved in the cross section.

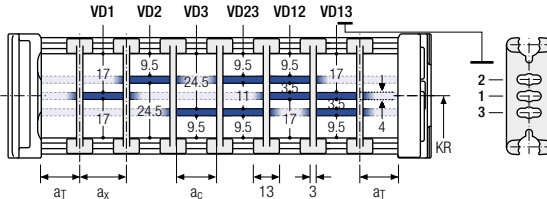

Divider system TS2 with partial height separation

Vers.	a _T min [mm]	a _x min [mm]	a _c min [mm]	n _T min
A	1.5	21	15	2

With grid distribution (1 mm grid).
The dividers are attached by the height separation, the grid can be moved in the cross section.

Sliding dividers are optionally available (thickness of divider = 3 mm).

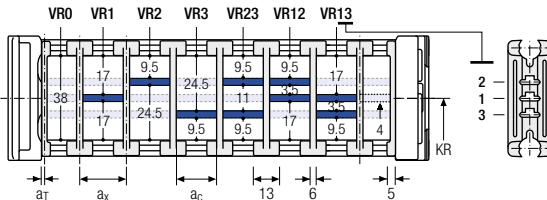

PROTUM® series
K series
UNIFLEX Advanced series
M series
XL series
QUANTUM® series
TKR series
TKA series
UAT series



TRAXLINE® cables for cable carriers
Hi-flex electric cables which were especially developed, optimized and tested for use in cable carriers can be found at tsubaki-kabelschlepp.com/traxline

Divider system TS3 with height separation made of plastic partitions

Vers.	a_T min [mm]	a_x min [mm]	a_c min [mm]	n_T min
A	4	16 / 42*	8	2

* For aluminum partitions

The dividers are fixed by the partitions, the complete divider system is movable in the cross section.

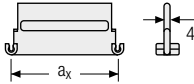
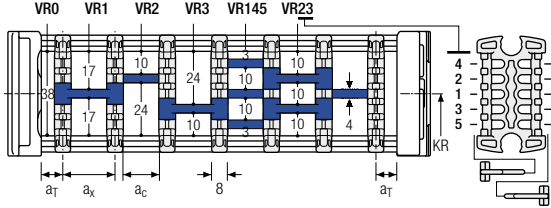

Aluminum partitions in 1 mm increments with $a_x > 42$ mm are also available.

a_x (center distance of dividers) [mm]											
a_c (nominal width of inner chamber) [mm]											
16	18	23	28	32	33	38	43	48	58	64	68
8	10	15	20	24	25	30	35	40	50	56	60
78	80	88	96	112	128	144	160	176	192	208	
70	72	80	88	104	120	136	152	168	184	200	

When using **plastic partitions with $a_x > 112$ mm**, we recommend an additional center support with a **twin divider** ($S_T = 3$ mm). Twin dividers are also suitable for retrofitting in the partition system.

Order example



TS3	A	3	K1	34	VR1
			⋮	⋮	⋮
			K4	38	VR3
Divider system	Version	n_T	Chamber	a_x	Height separation

Please state the designation of the divider system (**TS0, TS1 ...**), version and number of dividers per cross section [n_T]. In addition, please also enter the chambers [K] from left to right, as well as the assembly distances [a_T/a_x] (as seen from the driver).

If using divider systems with height separation (**TS1, TS3**) please also state the positions [e.g. VD23] viewed from the left driver belt. You are welcome to add a sketch to your order.

More product information online



Assembly instructions etc.:
Additional info via your
smartphone or check online at
[tsubaki-kabelschlepp.com/
support](http://tsubaki-kabelschlepp.com/support)



Configure your custom
cable carrier here:
online-engineer.de



PROTUM®
series

K
series

UNIFLEX
Advanced
series

M
series

XL
series

QUANTUM®
series

TKR
series

TKA
series

UAT
series

Aluminum stay LG – Hole stay, split version

- Optimum cable routing in the neutral bending line. Split version for easy cable routing. Stays also available unsplit.
- Available customized in **1 mm width sections**.
- **Outside/inside:** Screw-fixing easy to release.



Stay arrangement on every 2nd chain link, **standard** (HS: half-stayed)



Stay arrangement on each chain link (**VS: fully-stayed**)



1 mm B_i 75 – 600 mm in **1 mm width sections**

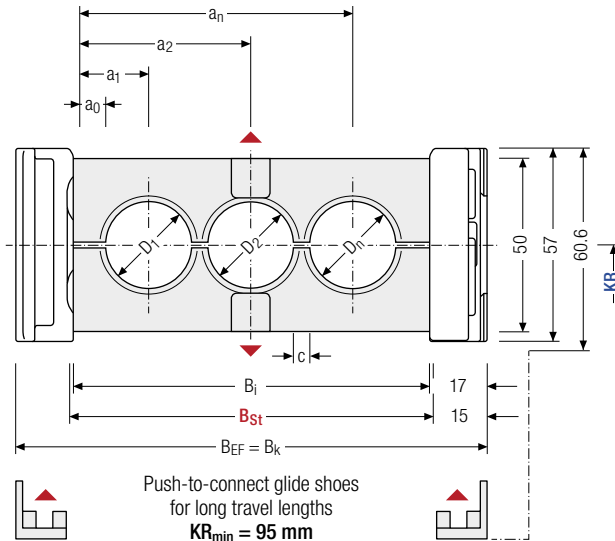

The maximum cable diameter strongly depends on the bending radius and the desired cable type. Please contact us.

Calculating the cable carrier length

Cable carrier length L_k

$$L_k \approx \frac{L_s}{2} + L_B$$

Cable carrier length L_k rounded to pitch t

Calculating the stay width

Stay width B_{St}

$$B_{St} = \sum D + \sum c + 2 a_0$$

D _{max} [mm]	D _{min} [mm]	h _G [mm]	B _i [mm]	B _{St} [mm]*	B _k [mm]	B _{EF} [mm]	c _{min} [mm]	a _{0 min} [mm]	KR [mm]				q _k 50 %** [kg/m]
36	9	57	75 – 600	79 – 604	B _{St} + 30	B _{St} + 30	4	10	75	95	115	145	2.39 – 4.66
									175	220	260	275	
									300	350			

* in 1 mm width sections

** Hole ratio of the hole stay approx. 50 %

Order example



MC0650

Type

300

B_i [mm]

LG

Stay variant

175

KR [mm]

1430

L_k [mm]

HS

Stay arrangement

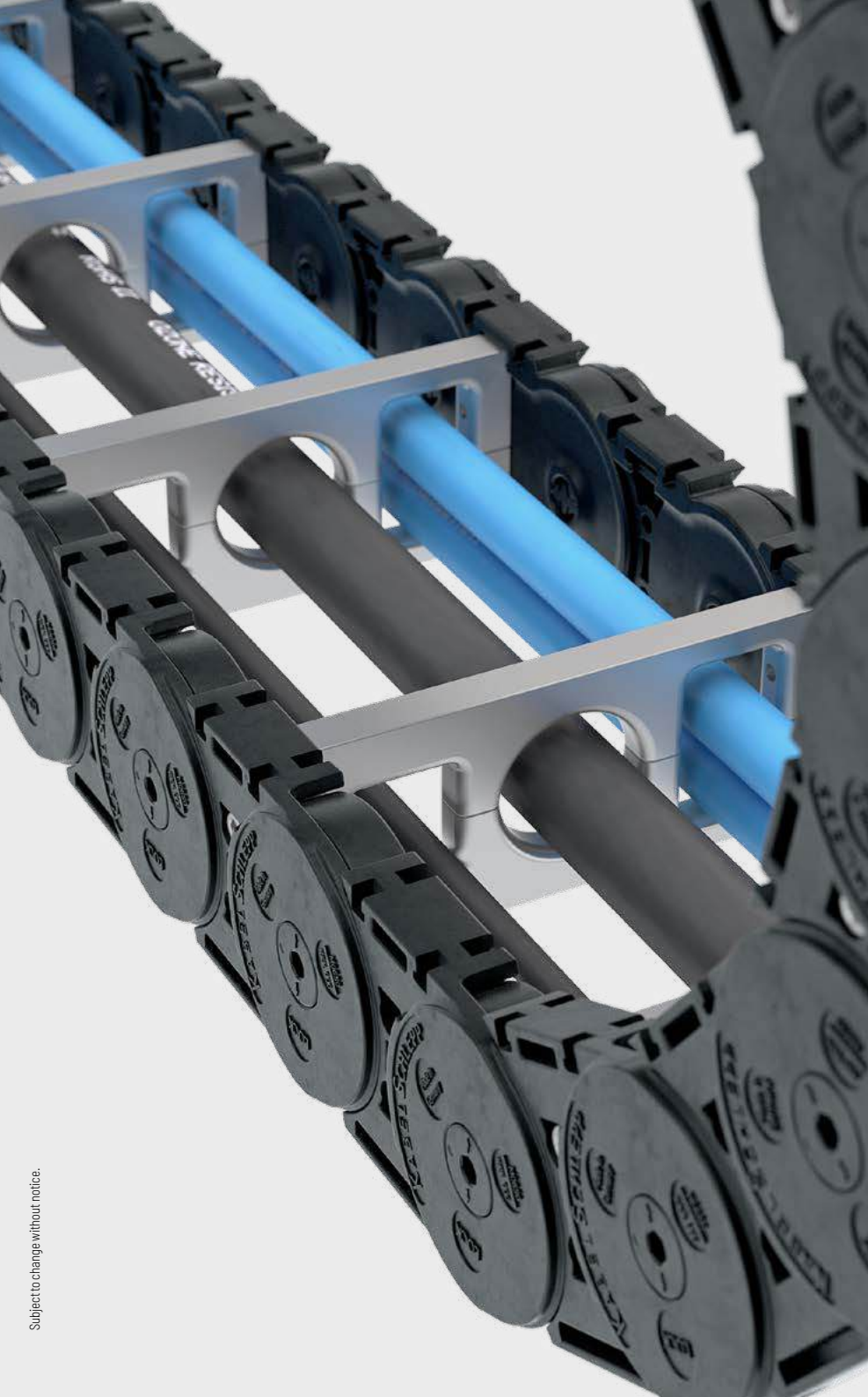

PROTUM®
series

K
series

UNIFLEX
Advanced
series

M
series

XL
series

QUANTUM®
series

TKR
series

TKA
series

UAT
series

Aluminum stay RMA – mounting frame stay

- Aluminum profile bars with plastic mounting frame stays for guiding very large cable diameters.
- The mounting frame stay can be mounted either inside or outside in the bending radius. Available customized in **1 mm width sections**.
- Outside/inside:** Screw-fixing easy to release.



Stay arrangement on every 2nd chain link, **standard** (HS: half-stayed)



Stay arrangement on each chain link (**VS: fully-stayed**)



B_i 200 – 400 mm in **1 mm width sections**

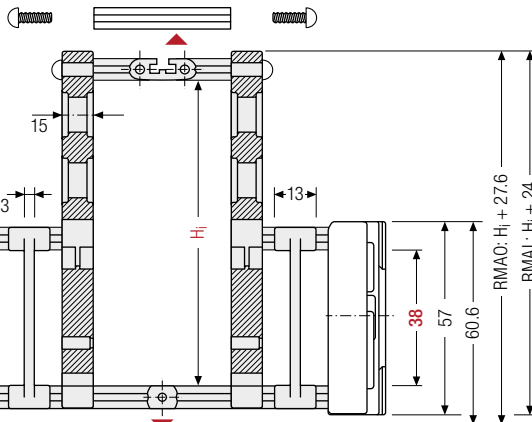

The maximum cable diameter strongly depends on the bending radius and the desired cable type. Please contact us.

Calculating the cable carrier length

Cable carrier length L_k

$$L_k \approx \frac{L_S}{2} + L_B$$

Cable carrier length L_k rounded to pitch t



Intrinsic cable carrier weight

Determining the intrinsic cable carrier weight strongly depends on the selected stay arrangement. Please contact us.

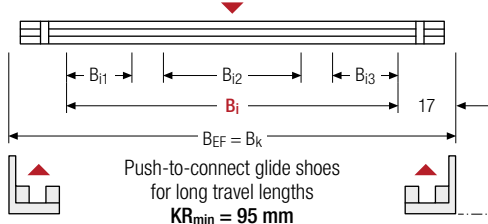

Push-to-connect glide shoes
for long travel lengths
 $KR_{min} = 95 \text{ mm}$

h_i [mm]	H_i [mm]	h_G [mm]	B_i [mm]	$B_{i1 \text{ min}}$ [mm]	$B_{i3 \text{ min}}$ [mm]	B_k [mm]	B_{EF} [mm]	KR [mm]				
38	130 160	57	200 – 400	16	16	$B_i + 34$	$B_i + 34$	75	95	115	145	175
	200							220	260	275	300	350

Order example



MC0650

Type

300

B_i [mm]

RMAO

Stay variant

175

KR [mm]

1430

L_k [mm]

HS

Stay arrangement

Assembly variants

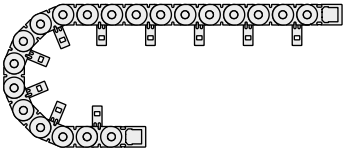

RMAI – assembly to the inside:

Gliding application is not possible when using assembly version RMAI.

Observe minimum KR:

H_i = 130 mm: KR_{min} = 220 mm

H_i = 160 mm: KR_{min} = 300 mm

H_i = 200 mm: KR_{min} = 300 mm

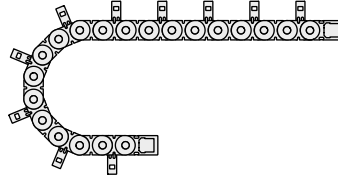

RMAO – assembly to the outside:

The cable carrier has to rest on the side bands and not on the stays.

Guiding in a **channel is required** for support.

Please contact our technical support at technik@kabelschlepp.de to find the corresponding guide channel.

Please note the operating and installation height.



Subject to change without notice.

PROTUM® series
K series
UNIFLEX Advanced series
M series
XL series
QUANTUM® series
TKR series
TKA series
UAT series

Plastic stay RE – screw-in frame stay

- Plastic profile bars for light to medium loads.
Assembly without screws.
- Available customized in **8 mm grid**.
- **Outside/inside:** release by turning by 90°.



Stay arrangement on every
2nd chain link, **standard**
(**HS: half-stayed**)



Stay arrangement on each
chain link (**VS: fully-stayed**)



8 mm B_i 50 – 266 mm
in **8 mm width sections**

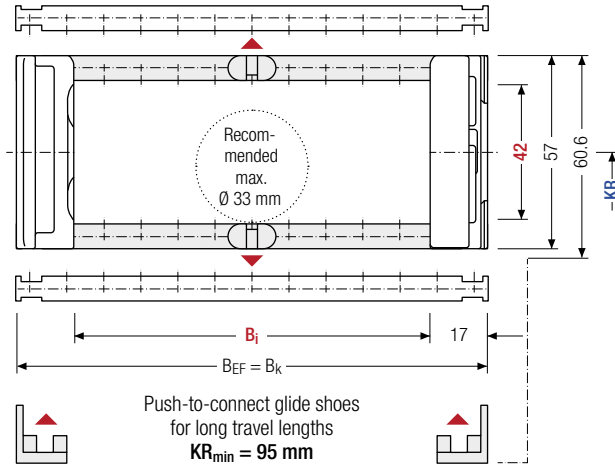

The maximum cable diameter strongly depends on the bending radius and the desired cable type. Please contact us.

For rough environmental conditions, we recommend the use of OFFROAD glide shoes with 80 % higher wear volume.

Calculating the cable carrier length

Cable carrier length L_k

$$L_k \approx \frac{L_s}{2} + L_B$$

Cable carrier length L_k
rounded to pitch t

h _i [mm]	h _G [mm]	h _{G'} [mm]	h _{G'} Offroad [mm]	B _i [mm]					B _K [mm]	B _{EF} [mm]	KR [mm]		q _k [kg/m]	
42	57	60.6	62.2	50	58	66	74	82	90	B _i + 34	B _i + 34	75	95	2.00 – 2.84
				98	106	114	122	130	138			115	145	
				146	154	162	170	178	186			175	220	
				194	202	210	218	226	234			260	275	
				242	250	258	266	300	350					

Order example



ME0650

Type

210

B_i [mm]

RE

Stay variant

175

KR [mm]

1430

L_k [mm]

HS

Stay arrangement

Plastic stay RD – Frame stay with hinge



- Plastic profile bars with hinge for light to medium loads. Assembly without screws.
- Available customized in **8 mm grid**.
- **Outside:** swivable to both sides.
- **Inside:** release by turning by 90°.

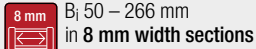
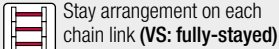
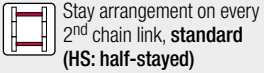

PROTUM® series

K series

UNIFLEX Advanced series

M series

XL series

QUANTUM® series

TKR series

TKA series

UAT series

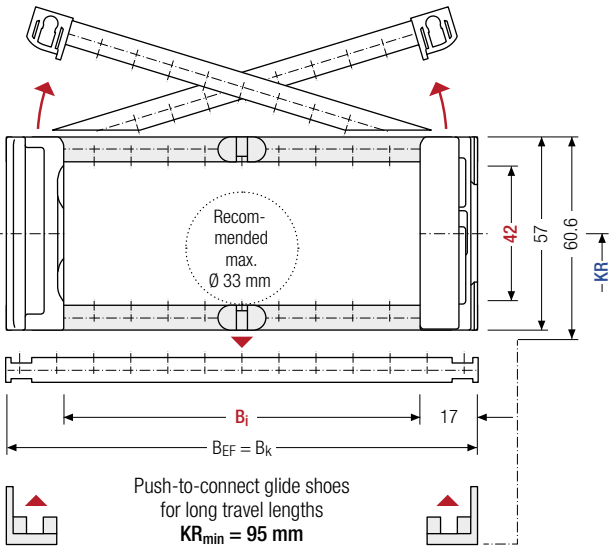

i The maximum cable diameter strongly depends on the bending radius and the desired cable type. Please contact us.

i For rough environmental conditions, we recommend the use of OFFROAD glide shoes with 80 % higher wear volume.

Calculating the cable carrier length

Cable carrier length L_k

$$L_k \approx \frac{L_s}{2} + L_B$$

Cable carrier length L_k rounded to pitch t

h _i [mm]	h _g [mm]	h _{g'} [mm]	h _{g'} Offroad [mm]	B _i [mm]						B _k [mm]	B _{EF} [mm]	KR [mm]		q _k [kg/m]	
42	57	60.6	62.2	50	58	66	74	82	90	B _i + 34	B _i + 34	75	95	2.00	
				98	106	114	122	130	138			115	145		
				146	154	162	170	178	186			175	220		–
				194	202	210	218	226	234			260	275		
				242	250	258	266	300	350			2.84			

Order example

MK0650 ·
 210 ·
 RD ·
 175 ·
 1430 ·
 HS
 Type B_i [mm] Stay variant KR [mm] L_k [mm] Stay arrangement

Divider systems

As a standard, the divider system is mounted on each crossbar – for stay mounting on every 2nd chain link (HS).

As a standard, dividers and the complete divider system (dividers with height separations) can be moved in the cross section (**version A**).

The dividers are easily attached to the stay for applications with lateral acceleration and for applications laying on their side by simply turning the frame stay by 180°. The arresting cams click into place in the locking grids in the crossbars (**version B**). The groove in the frame stay faces outwards.

Divider system TSO without height separation

Vers.	a_T min [mm]	a_x min [mm]	a_c min [mm]	a_x Raster [mm]	n_T min
A	6.5	13	8.8	–	–
B	13	16	11.8	8	–

The dividers can be moved within the cross section (version A) or fixed (version B).

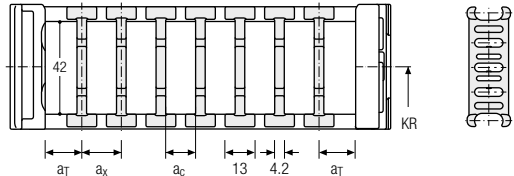

Divider system TS1 with continuous height separation

Vers.	a_T min [mm]	a_T max [mm]	a_x min [mm]	a_c min [mm]	a_x Raster [mm]	n_T min
A	6.5	25	13	8.8	–	2

The dividers can be moved within the cross section.

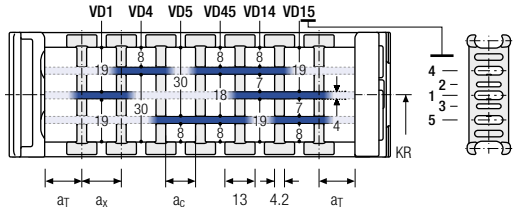

TOTALTRAX® complete systems

Benefit from the advantages of the TOTALTRAX® complete system. A complete delivery from one source – with a warranty certificate on request! Learn more at tsubaki-kabelschlepp.com/totaltrax



TRAXLINE® cables for cable carriers

Hi-flex electric cables which were especially developed, optimized and tested for use in cable carriers can be found at tsubaki-kabelschlepp.com/traxline

Divider system TS3 with height separation made of plastic partitions

Vers.	a _T min [mm]	a _x min [mm]	a _c min [mm]	n _T min
A	4	16 / 42*	8	2

* For aluminum partitions

The dividers are fixed by the partitions, the complete divider system is movable in the cross section.

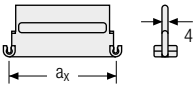
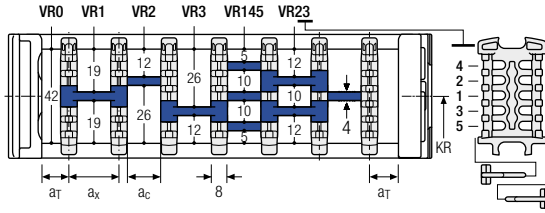

Aluminum partitions in 1 mm increments with a_x > 42 mm are also available.

a _x (center distance of dividers) [mm]											
a _c (nominal width of inner chamber) [mm]											
16	18	23	28	32	33	38	43	48	58	64	68
8	10	15	20	24	25	30	35	40	50	56	60
78	80	88	96	112	128	144	160	176	192	208	
70	72	80	88	104	120	136	152	168	184	200	

When using plastic partitions with a_x > 112 mm, we recommend an additional center support with a twin divider (S_T = 3 mm). Twin dividers are also suitable for retrofitting in the partition system.

Order example

TS3

A

2

K1

34

VR1

⋮
 ⋮
 ⋮

K4

38

VR3

Divider system
Version
n_T
Chamber
a_x
Height separation

Please state the designation of the divider system (TS0, TS1 ...), version and number of dividers per cross section [n_T]. In addition, please also enter the chambers [K] from left to right, as well as the assembly distances [a_T/a_x] (as seen from the driver).

If using divider systems with height separation (TS1, TS3) please also state the positions [e.g. VD23] viewed from the left driver belt. You are welcome to add a sketch to your order.

More product information online



Assembly instructions etc.: Additional info via your smartphone or check online at tsubaki-kabelschlepp.com/downloads



Configure your custom cable carrier: here online-engineer.de

- PROTUM® series
- K series
- UNIFLEX Advanced series
- M series
- XL series
- QUANTUM® series
- TKR series
- TKA series
- UAT series

PROTUM®
series

K
series

UNIFLEX
Advanced
series

M
series

XL
series

QUANTUM®
series

TKR
series

TKA
series

UAT
series

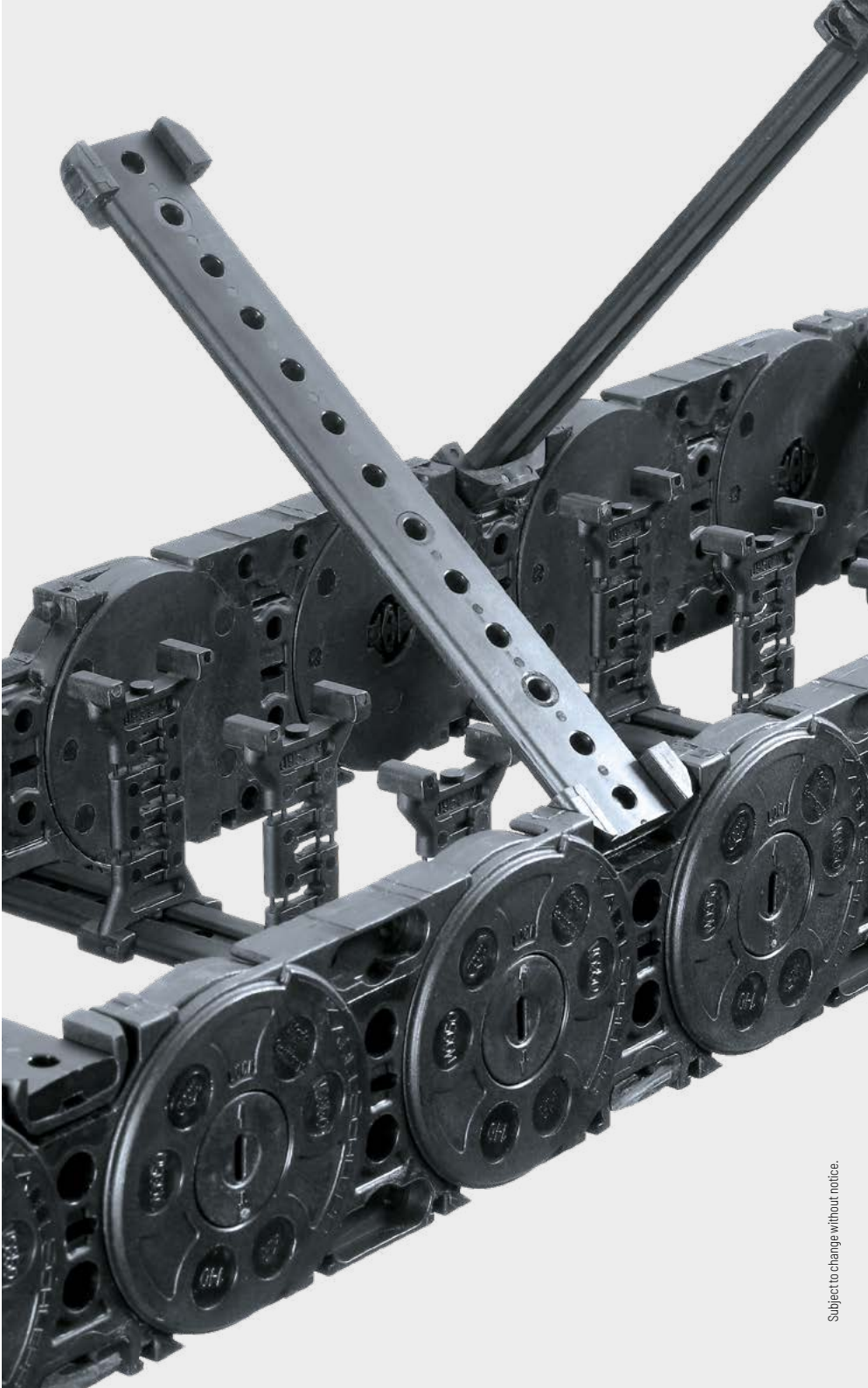

Universal end connectors UMB – plastic (standard)

The universal mounting brackets (UMB) are made from plastic and can be mounted from the top, from the bottom, face on or from the side.

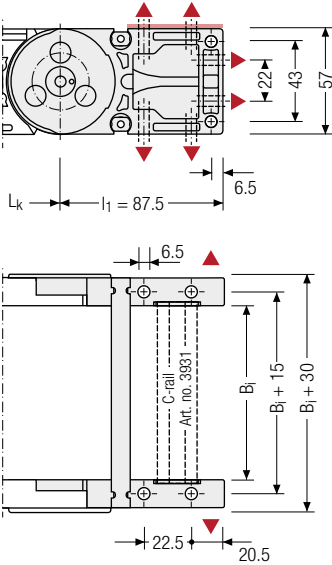

Recommended tightening torque: 11 Nm for cheese-head screws ISO 4762 - M6 - 8.8

End connectors – plastic/steel

Plastic link end connector, steel end connector. The connection variants on the fixed point and on the driver can be combined and, if required, changed afterwards.

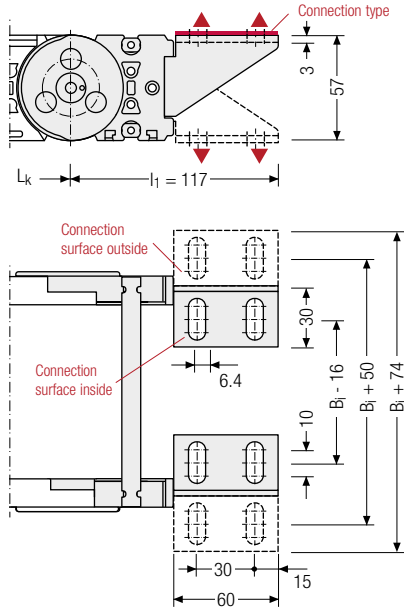

Assembly options

Connection point

- F – fixed point
- M – driver

Connection type

- U – universal mounting bracket

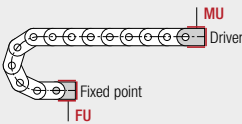

Connection point

- F – fixed point
- M – driver

Connection surface

- I – connection surface inside
- A – connection surface outside

Connection type

- A – threaded joint outside (standard)
- I – threaded joint inside
- F – flange connection

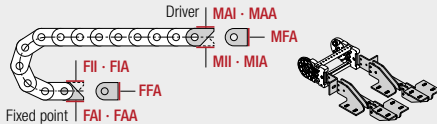

Order example

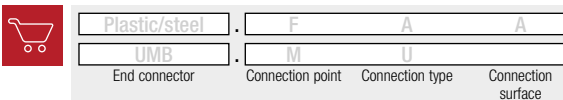

We recommend the use of strain reliefs at the driver and fixed point. See from p. 904.

PROTUM® series

K series

UNIFLEX Advanced series

M series

XL series

QUANTUM® series

TKR series

TKA series

UAT series

M0950



Pitch
95 mm



Inner heights
50 – 58 mm



Inner widths
45 – 600 mm

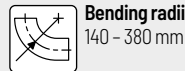

Bending radii
140 – 380 mm

Stay variants



Aluminum stay RS page **392**

Frame stay, narrow "The standard"

- » Aluminum profile bars for light to medium loads. Assembly without screws.
- » **Outside/inside:** release by turning by 90°.



Aluminum stay RV page **396**

Frame stay, reinforced

- » Aluminum profile bars with plastic adapter for medium to high loads and large cable carrier widths. Assembly without screws.
- » **Outside/inside:** release by turning by 90°.

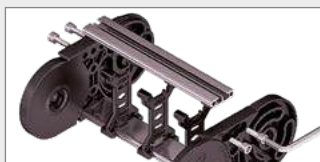

Aluminum stay RM page **400**

Frame stay, solid

- » Aluminum profile bars for heavy loads and maximum cable carrier widths. Double threaded joints on both sides "Heavy Duty".
- » **Inside/outside:** Threaded joint easy to release.

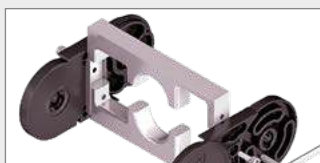

Aluminum stay LG page **402**

Hole stay, split version

- » Optimum cable routing in the neutral bending line. Split version for easy cable routing. Stays also available unsplit.
- » **Outside/inside:** Screw-fixing easy to release.

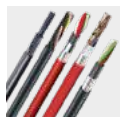

TRAXLINE® cables for cable carriers

Hi-flex electric cables which were specially developed, optimised and tested for use in cable carriers can be found at tsubaki-kabelschlepp.com/traxline.

Stay variants



Aluminum stay RMA page 404

Mounting frame stay

- » Aluminum profile bars with plastic mounting frame stays for guiding very large cable diameters.
- » **Outside/inside:** Screw-fixing easy to release.



Aluminum stay RMR page 406

Frame rolling stay

- » Aluminum profile bars with rotating plastic rolling stay for highest requirements with gentle cable guiding. Double threaded joint on both sides.
- » **Inside/outside:** threaded joint easy to release.



Plastic stay RE page 408

Frame screw-in stay

- » Plastic profile bars for light to medium loads. Assembly without screws.
- » **Outside/inside:** release by turning by 90°.



Plastic stay RD page 409

Frame stay with hinge

- » Plastic profile bars with hinge for light to medium loads. Assembly without screws.
- » **Outside:** swivable to both sides.
- » **Inside:** release by turning by 90°.

MT series

Also available as covered variants with cover system.
More information can be found in chapter "MT series" from p. 612.



PROTUM®
series

K
series

UNIFLEX
Advanced
series

M
series

XL
series

QUANTUM®
series

TKR
series

TKA
series

UAT
series



Unsupported arrangement

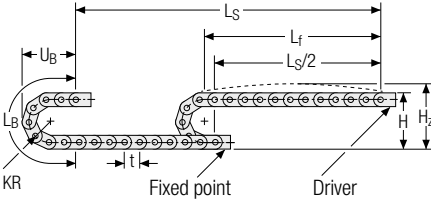

KR [mm]	H [mm]	H _z [mm]	L _B [mm]	U _B [mm]
140	360	405	630	275
170	420	465	725	305
200	480	525	819	335
260	600	645	1007	395
290	660	705	1102	425
320	720	765	1196	445
380	840	885	1384	515

Load diagram for unsupported length depending on the additional load.

Sagging of the cable carrier is technically permitted for extended travel lengths, depending on the specific application.

Intrinsic cable carrier weight $q_k = 4.5 \text{ kg/m}$. For other inner widths, the maximum additional load changes.

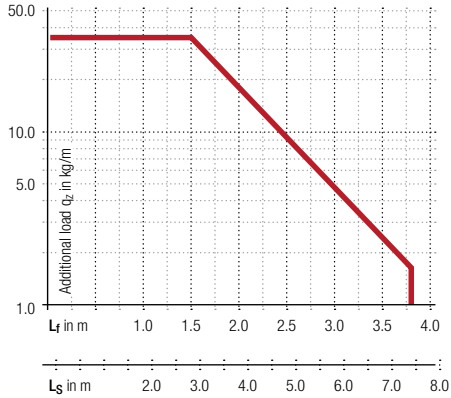

Speed
up to 10 m/s

Acceleration
up to 30 m/s²

Travel length
up to 7.4 m

Additional load
up to 35 kg/m

Gliding arrangement | GO module with chain links optimized for gliding

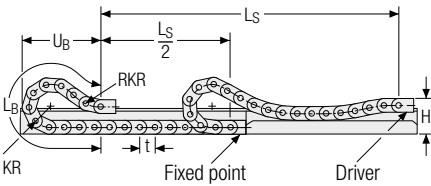

KR [mm]	H [mm]	GO module RKR [mm]	L _B [mm]	U _B [mm]
140	240	500	1580	740
170	240	500	1710	773
200	240	500	1995	888
260	240	500	2565	1114
290	240	500	2755	1183
320	240	500	3040	1296
380	240	500	3610	1523

Speed
up to 8 m/s

Acceleration
up to 20 m/s²

Travel length
up to 260 m

Additional load
up to 35 kg/m

The gliding cable carrier must be guided in a channel. See p. 844.

The GO module mounted on the driver is a defined sequence of 4 adapted KR/RKR link plates.

Gliding shoes have to be used for gliding applications.

Our technical support can provide help for gliding arrangements:
technik@kabelschlepp.de

PROTUM® series
K series
UNIFLEX Advanced series
M series
XL series
QUANTUM® series
TKR series
TKA series
UAT series

Aluminum stay RS – frame stay narrow

- Extremely quick to open and close
- Aluminum profile bars for light to medium loads.
Assembly without screws.
- Available customized in **1 mm grid**.
- **Outside/inside:** release by turning by 90°.

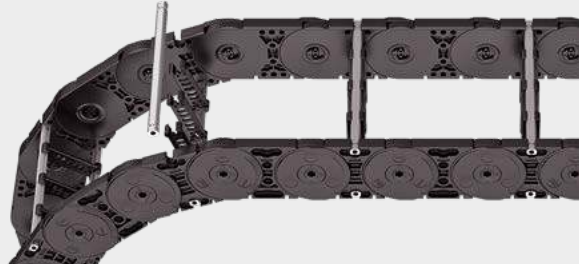

Stay arrangement on every
2nd chain link, **standard**
(HS: half-stayed)



Stay arrangement on each
chain link (VS: fully-stayed)



1 mm B_i 75 – 400 mm
in **1 mm** width sections

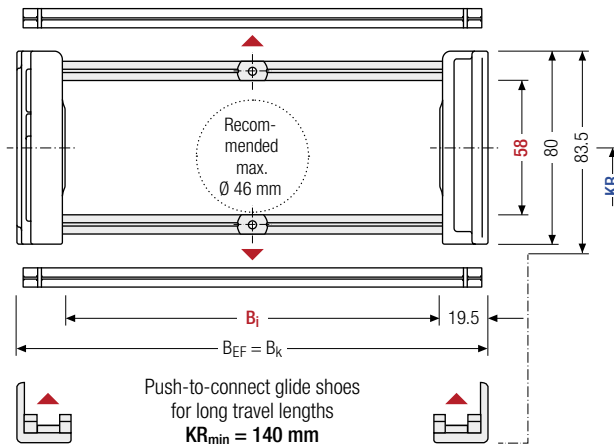

The maximum cable diameter strongly depends on the bending radius and the desired cable type. Please contact us.

For rough environmental conditions, we recommend the use of OFFROAD glide shoes with 80 % higher wear volume.

Calculating the cable carrier length

Cable carrier length L_k

$$L_k \approx \frac{L_s}{2} + L_B$$

Cable carrier length L_k
rounded to pitch t

h _i [mm]	h _G [mm]	h _{G'} [mm]	h _{G'} Offroad [mm]	B _i [mm]*	B _k [mm]	B _{EF} [mm]	KR [mm]				q _k [kg/m]
58	80	83.5	86	75 – 400	B _i + 39	B _i + 39	140	170	200	260	2.93 – 4.71
							290	320	380		

* in 1 mm width sections

Order example



MC0950

Type

400

B_i [mm]

RS

Stay variant

200

KR [mm]

2850

L_k [mm]

HS

Stay arrangement

Divider systems

As a standard, the divider system is mounted on each crossbar – for stay mounting on every 2nd chain link (HS).

As a standard, dividers and the complete divider system (dividers with height separations) can be moved in the cross section (**version A**).

For applications with lateral acceleration and rotated by 90°, the dividers can be attached by simply clipping on a socket (available as an accessory).

The socket additionally serves as a spacer between the dividers and is available in 1 mm sections between 3 – 50 mm. The inner height is reduced to 54 mm (**version B**).

Divider system TSO without height separation

Vers.	a _T min [mm]	a _x min [mm]	a _c min [mm]	π _T min
A	4.5	14	10	2

The dividers can be moved in the cross section.

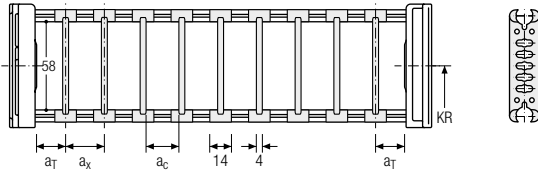

Divider system TS1 with continuous height separation

Vers.	a _T min [mm]	a _T max [mm]	a _x min [mm]	a _c min [mm]	π _T min
A	4.5	25	14	10	2

The dividers can be moved in the cross section.

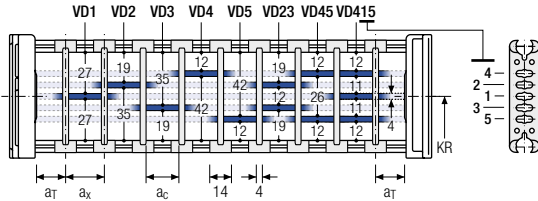

Divider system TS2 with partial height separation

Vers.	a _T min [mm]	a _x min [mm]	a _c min [mm]	π _T min
A	4.5	23	19	2

With grid distribution (1 mm grid). The dividers are attached by the height separation, the grid can be moved in the cross section.

Sliding dividers are optionally available (thickness of divider = 4 mm).

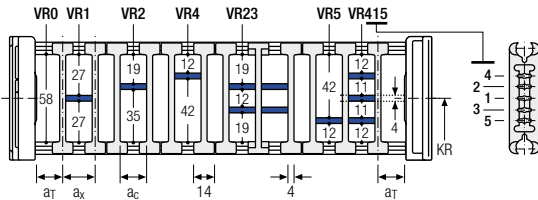

Please note that the real dimensions may deviate slightly from the values indicated here.

Order example

TS2

A

3

K1

34

VR1

⋮

⋮

⋮

π_T

K4

38

VR3

Divider system

Version

π_T

Chamber

a_x

Height separation

PROTUM® series
K series
UNIFLEX Advanced series
M series
XL series
QUANTUM® series
TKR series
TKA series
UAT series

Divider system TS3 with height separation consisting of plastic partitions

As a standard, the divider **version A** is used for vertical partitioning within the cable carrier. The complete divider system can be moved within the cross section.

PROTUM® series

K series

Divider version A

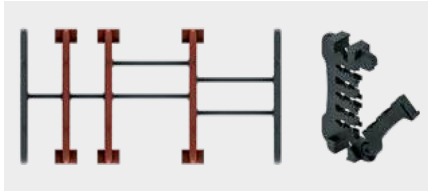

End divider

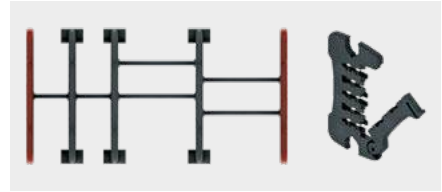

UNIFLEX Advanced series

M series

Vers.	a _T min [mm]	a _x min [mm]	a _c min [mm]	n _T min
A	6/2*	14	10	2

* For End divider

The dividers are fixed by the partitions, the complete divider system is movable in the cross section.

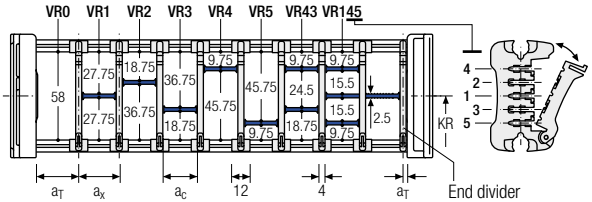

XL series

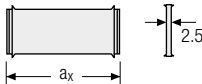

a _x (center distance of dividers) [mm]																
a _c (nominal width of inner chamber) [mm]																
14	16	19	23	24	28	29	32	33	34	38	39	43	44	48	49	54
10	12	15	19	20	24	25	28	29	30	34	35	39	40	44	45	50
58	59	64	68	69	74	78	79	80	84	88	89	94	96	99	112	
54	55	60	64	65	70	74	75	76	80	84	85	90	92	95	108	

When using partitions with a_x > 49 mm we recommended an additional preferential central support.

QUANTUM® series

TKR series

Order example

TS3 .
 A .
 3 .
 K1 .
 34 -
 VR1
 ⋮
 ⋮
 ⋮
K4 .
 38 -
 VR3

Divider system
Version
n_T
Chamber
a_x
Height separation

TKA series

Please state the designation of the divider system (TS0, TS1,...), version and number of dividers per cross section [n_T]. In addition, please also enter the chambers [K] from left to right, as well as the assembly distances [a_T/a_x] (as seen from the driver).

If using divider systems with height separation (TS1, TS3) please also state the positions [e.g. VD23] viewed from the left driver belt. You are welcome to add a sketch to your order.

UAT series



PROTUM®
series

K
series

UNIFLEX
Advanced
series

M
series

XL
series

QUANTUM®
series

TKR
series

TKA
series

UAT
series

Aluminum stay RV – frame stay reinforced

- Aluminum profile bars with plastic adapter for medium to high loads and large cable carrier widths. Assembly without screws.
- Available customized in **1 mm grid**.
- **Outside/inside:** release by turning by 90°.

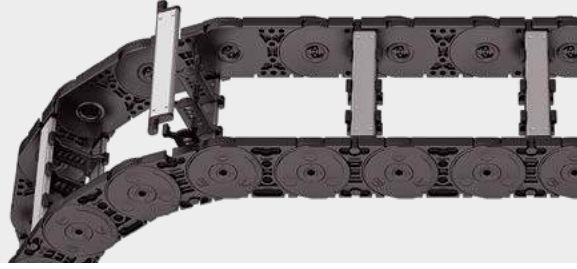

Stay arrangement on every 2nd chain link, **standard (HS: half-stayed)**



Stay arrangement on each chain link (**VS: fully-stayed**)



1 mm B_i 75 – 500 mm in **1 mm width sections**

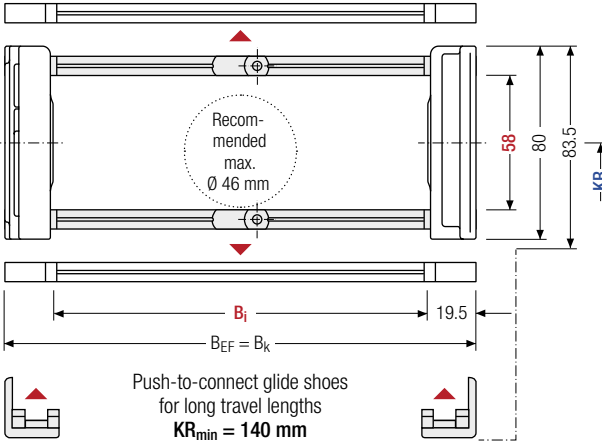

The maximum cable diameter strongly depends on the bending radius and the desired cable type. Please contact us.

For rough environmental conditions, we recommend the use of OFFROAD glide shoes with 80 % higher wear volume.

Calculating the cable carrier length

Cable carrier length L_k

$$L_k \approx \frac{L_s}{2} + L_B$$

Cable carrier length L_k rounded to pitch t

h_i [mm]	h_G [mm]	h_G^* [mm]	h_G^* Offroad [mm]	B_i [mm]*	B_k [mm]	B_{EF} [mm]	KR [mm]				q_k [kg/m]
58	80	83.5	86	75 – 500	$B_i + 39$	$B_i + 39$	140	170	200	260	3.32 – 6.02
							290	320	380		

* in 1 mm width sections

Order example



MC0950

Type

400

B_i [mm]

RV

Stay variant

200

KR [mm]

2850

L_k [mm]

HS

Stay arrangement

Divider systems

As a standard, the divider system is mounted on each crossbar – for stay mounting on every 2nd chain link (HS).

As a standard, dividers and the complete divider system (dividers with height separations) can be moved in the cross section (**version A**).

Divider system TSO without height separation

Vers.	a _T min [mm]	a _x min [mm]	a _c min [mm]	π _T min
A	4.5	14	10	2

The dividers can be moved in the cross section.

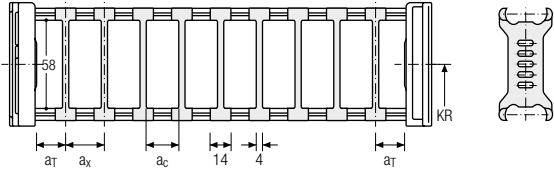

Divider system TS1 with continuous height separation

Vers.	a _T min [mm]	a _T max [mm]	a _x min [mm]	a _c min [mm]	π _T min
A	4.5	25	14	10	2

The dividers can be moved in the cross section.

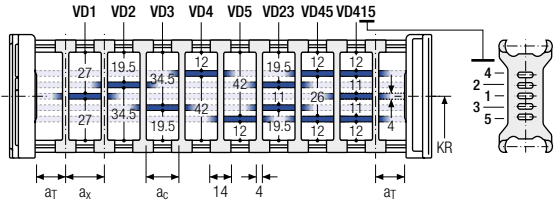

Divider system TS2 with partial height separation

Vers.	a _T min [mm]	a _x min [mm]	a _c min [mm]	π _T min
A	5.5	21	15	2

With grid distribution (1 mm grid). The dividers are attached by the height separation, the grid can be moved in the cross section.

Sliding dividers are optionally available (thickness of divider = 4 mm).

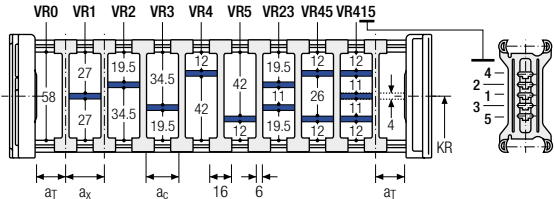

PROTUM® series
K series
UNIFLEX Advanced series
M series
XL series
QUANTUM® series
TKR series
TKA series
UAT series

TOTALTRAX® complete systems

Benefit from the advantages of the TOTALTRAX® complete system. A complete delivery from one source – with a warranty certificate on request! Learn more at tsubaki-kabelschlepp.com/totaltrax

TRAXLINE® cables for cable carriers

Hi-flex electric cables which were especially developed, optimized and tested for use in cable carriers can be found at tsubaki-kabelschlepp.com/traxline

Divider system TS3 with height separation made of plastic partitions

Vers.	a_T min [mm]	a_x min [mm]	a_c min [mm]	n_T min
A	4	16 / 42*	8	2

* For aluminum partitions

The dividers are fixed by the partitions, the complete divider system is movable in the cross section.

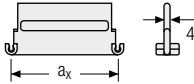

Aluminum partitions in 1 mm increments with $a_x > 42$ mm are also available.

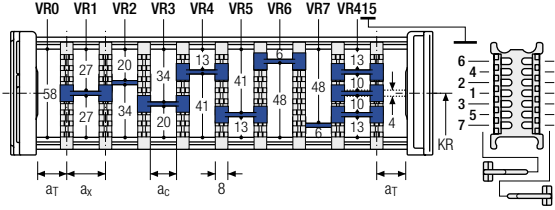

a_x (center distance of dividers) [mm]											
a_c (nominal width of inner chamber) [mm]											
16	18	23	28	32	33	38	43	48	58	64	68
8	10	15	20	24	25	30	35	40	50	56	60
78	80	88	96	112	128	144	160	176	192	208	
70	72	80	88	104	120	136	152	168	184	200	

When using **plastic partitions with $a_x > 112$ mm**, we recommend an additional center support with a **twin divider** ($S_T = 4$ mm). Twin dividers are also suitable for retrofitting in the partition system.

Order example



TS3	A	3	K1	34	VR1
			⋮	⋮	⋮
			K4	38	VR3
Divider system	Version	n_T	Chamber	a_x	Height separation

Please state the designation of the divider system (TS0, TS1 ...), version and number of dividers per cross section [n_T]. In addition, please also enter the chambers [K] from left to right, as well as the assembly distances [a_T/a_x] (as seen from the driver).

If using divider systems with height separation (TS1, TS3) please also state the positions [e.g. VD23] viewed from the left driver belt. You are welcome to add a sketch to your order.

More product information online



Assembly instructions etc.:
Additional info via your
smartphone or check online at
[tsubaki-kabelschlepp.com/
downloads](http://tsubaki-kabelschlepp.com/downloads)



Configure your custom
cable carrier here:
online-engineer.de

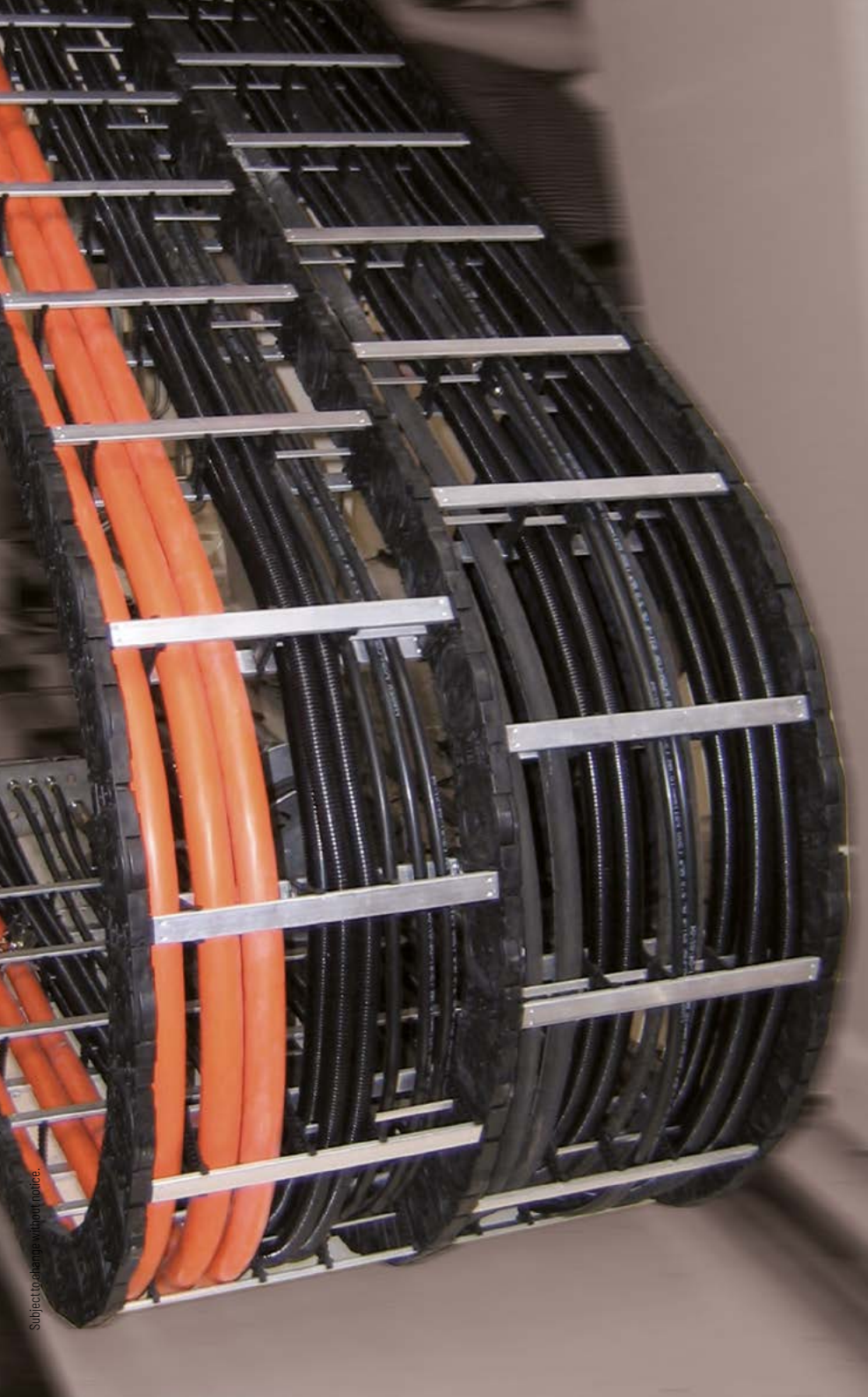

Subject to change without notice.

UAT
series

TKA
series

TKR
series

QUANTUM®
series

XL
series

M
series

UNIFLEX
Advanced
series

K
series

PROTUM®
series

Aluminum stay RM – frame stay solid

- Aluminum profile bars for heavy loads and maximum cable carrier widths. Double threaded joints on both sides “**Heavy Duty**”.
- Available customized in **1 mm grid**.
- **Inside/outside:** Threaded joint easy to release.

HEAVY DUTY
TSUBAKI KABELSCHLEPP

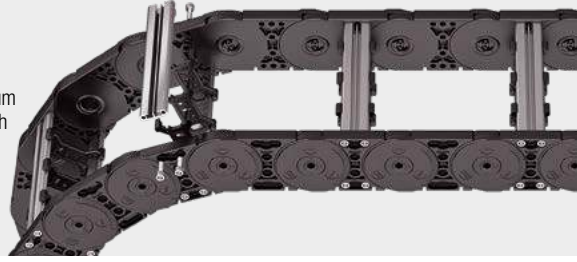

Stay arrangement on every 2nd chain link, **standard (HS: half-stayed)**



Stay arrangement on each chain link (**VS: fully-stayed**)



1 mm B_i 75 – 600 mm
in **1 mm width sections**

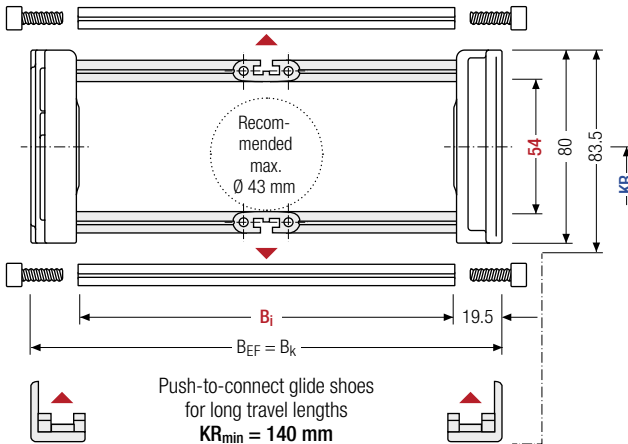

The maximum cable diameter strongly depends on the bending radius and the desired cable type. Please contact us.



For rough environmental conditions, we recommend the use of OFFROAD glide shoes with 80 % higher wear volume.

Calculating the cable carrier length

Cable carrier length L_k

$$L_k \approx \frac{L_s}{2} + L_B$$

Cable carrier length L_k rounded to pitch t

h_i [mm]	h_G [mm]	h_G' [mm]	h_G' Offroad [mm]	B_i [mm]*	B_k [mm]	B_{EF} [mm]	KR [mm]				q_k [kg/m]
54	80	83.5	86	75 – 600	$B_i + 39$	$B_i + 39$	140	170	200	260	3.63 – 6.55
							290	320	380		

* in 1 mm width sections

Order example



MC0950

Type

400

B_i [mm]

RM

Stay variant

200

KR [mm]

2850

L_k [mm]

HS

Stay arrangement

Divider systems

As a standard, the divider system is mounted on each crossbar – for stay mounting on every 2nd chain link (HS).

As a standard, dividers and the complete divider system (dividers with height separations) can be moved in the cross section (**version A**).

Divider system TSO without height separation

Vers.	a _T min [mm]	a _X min [mm]	a _C min [mm]	n _T min
A	4.5	14	10	–

The dividers can be moved in the cross section.

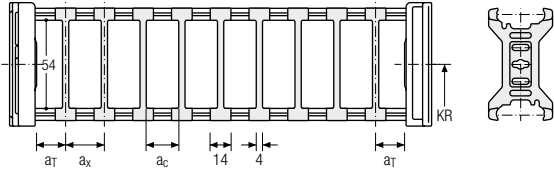

PROTUM® series

K series

UNIFLEX Advanced series

Divider system TS1 with continuous height separation

Vers.	a _T min [mm]	a _T max [mm]	a _X min [mm]	a _C min [mm]	n _T min
A	3.5	25	12	8	2

The dividers can be moved in the cross section.

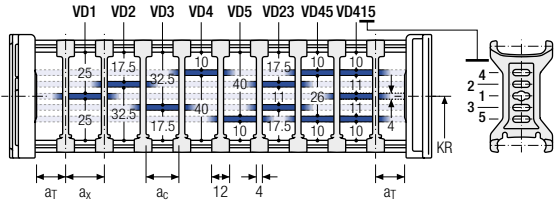

M series

Divider system TS2 with partial height separation

Vers.	a _T min [mm]	a _X min [mm]	a _C min [mm]	n _T min
A	4.5	21	15	2

With grid distribution (1 mm grid). The dividers are attached by the height separation, the grid can be moved in the cross section.

Sliding dividers are optionally available (thickness of divider = 4 mm).

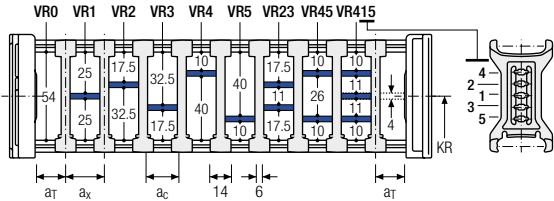

XL series

QUANTUM® series

Order example

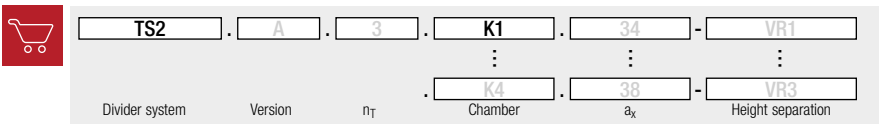

TKR series

TKA series

Please state the designation of the divider system (TS0, TS1 ...), version and number of dividers per cross section [n_T]. In addition, please also enter the chambers [K] from left to right, as well as the assembly distances [a_T/a_X] (as seen from the driver).

If using divider systems with height separation (TS1, TS2) please also state the positions [e.g. VD23] viewed from the left driver belt. You are welcome to add a sketch to your order.

UAT series

Aluminum stay LG – Hole stay, split version

- Optimum cable routing in the neutral bending line. Split version for easy cable routing. Stays also available unsplit.
- Available customized in **1 mm width sections**.
- **Outside/inside:** Screw-fixing easy to release.



Stay arrangement on every 2nd chain link, **standard** (HS: half-stayed)



Stay arrangement on each chain link (**VS: fully-stayed**)



1 mm B_i 75 – 600 mm in **1 mm width sections**

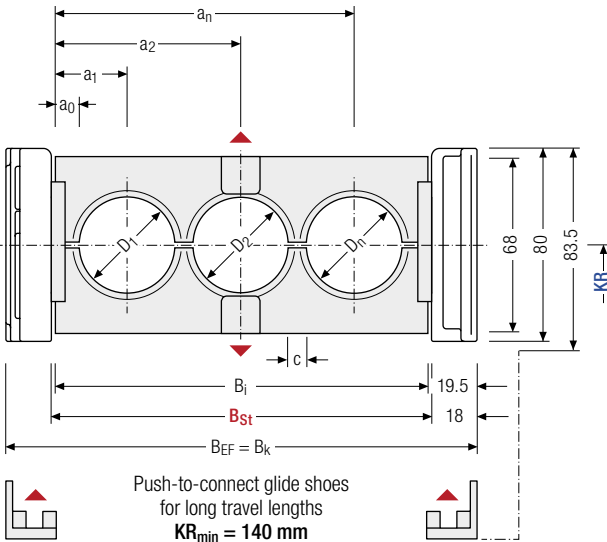

The maximum cable diameter strongly depends on the bending radius and the desired cable type. Please contact us.

Calculating the cable carrier length

Cable carrier length L_k

$$L_k \approx \frac{L_s}{2} + L_B$$

Cable carrier length L_k rounded to pitch t

Calculating the stay width

Stay width B_{St}

$$B_{St} = \sum D + \sum c + 2 a_0$$

D _{max} [mm]	D _{min} [mm]	h _G [mm]	B _i [mm]	B _{St} [mm]*	B _k [mm]	B _{EF} [mm]	c _{min} [mm]	a _{0 min} [mm]	KR [mm]	q _k 50%** [kg/m]
50	12	80	75 – 600	78 – 603	B _{St} + 39	B _{St} + 39	4	11	140 170 200 260 290 320 380	3.89 – 8.25

* in 1 mm width sections

** Hole ratio of the hole stay approx. 50 %

Order example



MC0950

Type

400

B_i [mm]

LG

Stay variant

200

KR [mm]

2850

L_k [mm]

HS

Stay arrangement

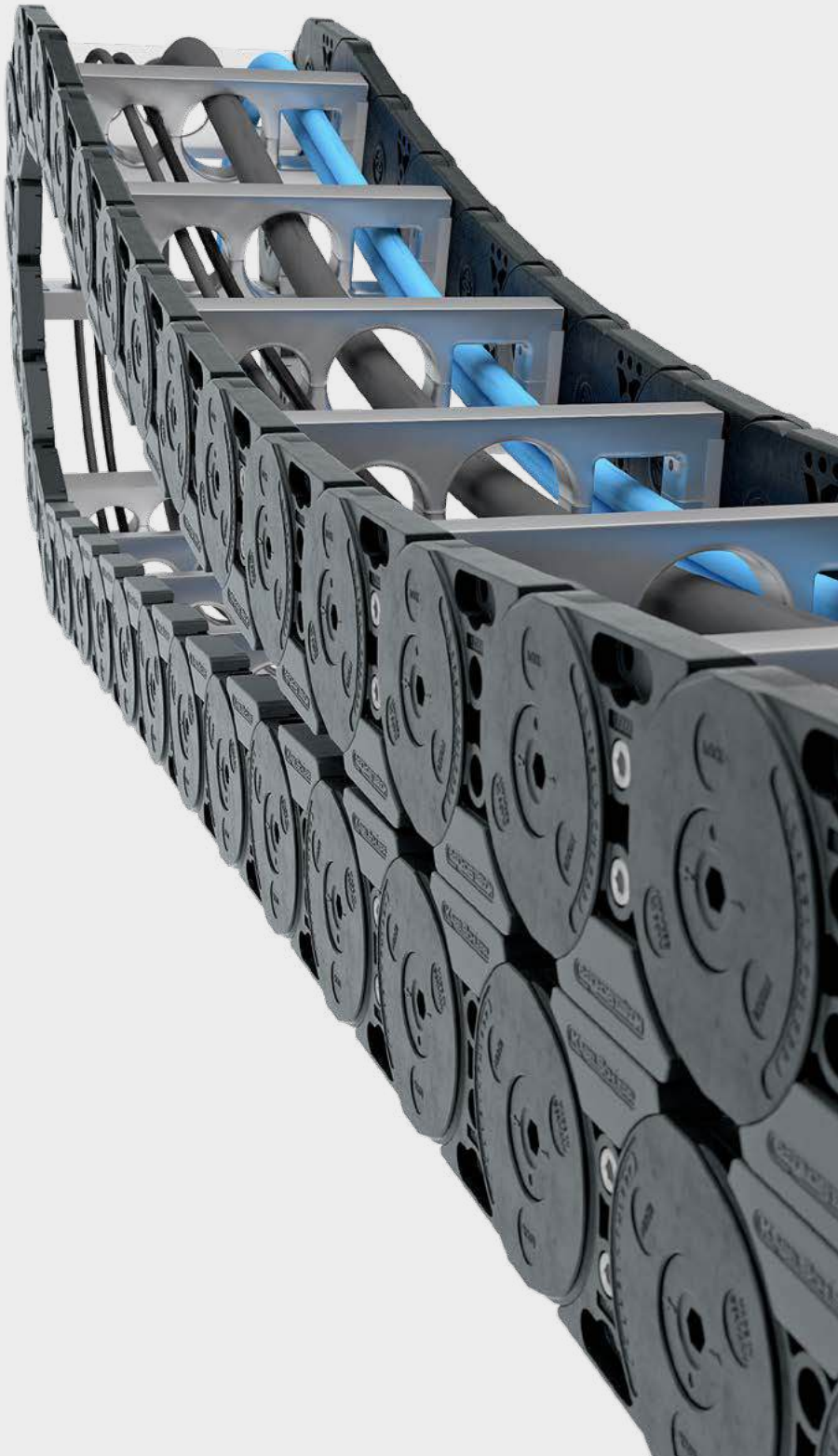

UAT
series

TKA
series

TKR
series

QUANTUM®
series

XL
series

M
series

UNIFLEX
Advanced
series

K
series

PROTUM®
series

Aluminum stay RMA – mounting frame stay

- Aluminum profile bars with plastic mounting frame stays for guiding very large cable diameters.
- The mounting frame stay can be mounted either inside or outside in the bending radius. Available customized in **1 mm width sections**.
- **Outside/inside:** Screw-fixing easy to release.

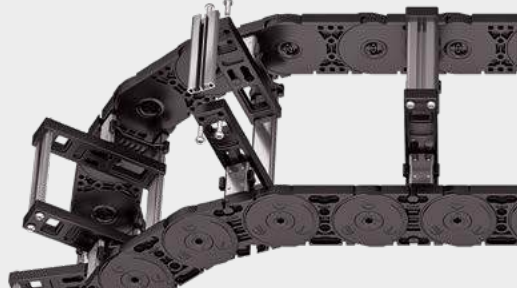

 Stay arrangement on every 2nd chain link, **standard (HS: half-stayed)**

 Stay arrangement on each chain link (**VS: fully-stayed**)

 **1 mm** B_i 200 – 500 mm in **1 mm width sections**

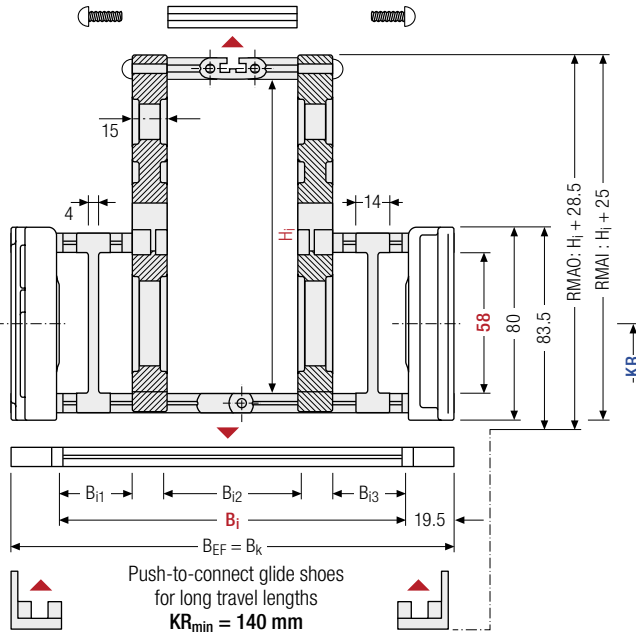

 The maximum cable diameter strongly depends on the bending radius and the desired cable type. Please contact us.

Calculating the cable carrier length

Cable carrier length L_k

$$L_k \approx \frac{L_s}{2} + L_B$$

Cable carrier length L_k rounded to pitch t

Intrinsic cable carrier weight

Determining the intrinsic cable carrier weight strongly depends on the selected stay arrangement. Please contact us.

h _i [mm]	H _i [mm]	h _G [mm]	B _i [mm]	B _{i1} min [mm]	B _{i3} min [mm]	B _k [mm]	B _{EF} [mm]	KR [mm]			
58	130 160	80	200 – 500	40	40	B _i + 39	B _i + 39	140 290	170 320	200 380	260

Order example

 **MC0950** Type · **400** B_i [mm] · **RMAO** Stay variant · **200** KR [mm] · **2850** L_k [mm] · **HS** Stay arrangement

Assembly variants

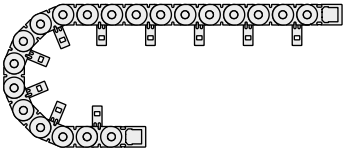

RMAI – assembly to the inside:

Gliding application is not possible when using assembly version RMAI.

Observe minimum KR:

$H_i = 130 \text{ mm}; KR_{\min} = 170 \text{ mm}$

$H_i = 160 \text{ mm}; KR_{\min} = 200 \text{ mm}$

$H_i = 200 \text{ mm}; KR_{\min} = 260 \text{ mm}$

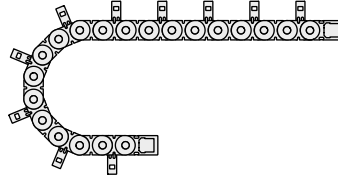

RMAI – assembly to the outside:

The cable carrier has to rest on the side bands and not on the stays.

Guiding in a **channel is required** for support.

Please contact our technical support at technik@kabelschlepp.de to find the corresponding guide channel.

Please note the operating and installation height.

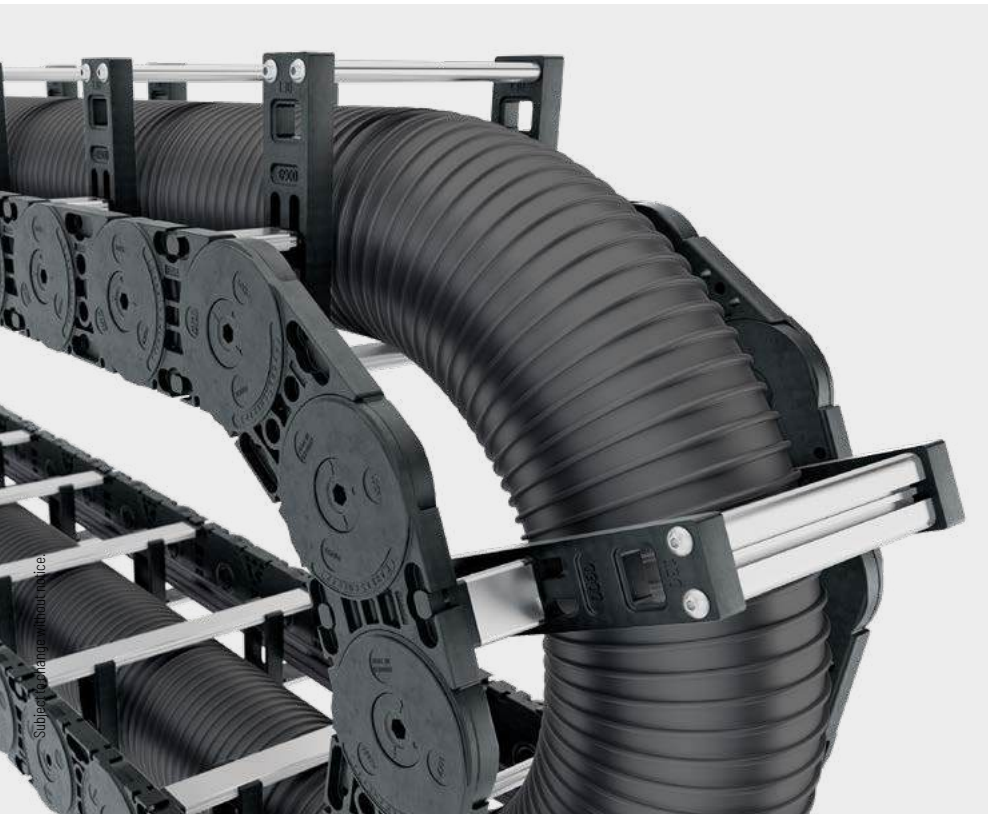

Subject to change without notice

PROTUM® series
K series
UNIFLEX Advanced series
M series
XL series
QUANTUM® series
TKR series
TKA series
UAT series

Aluminum stay RMR – Frame rolling stay

- Aluminum profile bars with rotating plastic rolling stay for highest requirements with gentle cable guiding. Double threaded joint on both sides.
- Available customized in **1 mm grid**.
- **Inside/outside:** Threaded joint easy to release.

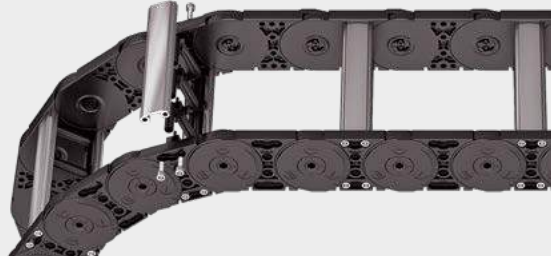

Stay arrangement on every 2nd chain link, **standard** (HS: half-stayed)



Stay arrangement on each chain link (**VS: fully-stayed**)



1 mm B_i 75 – 600 mm in 1 mm width sections

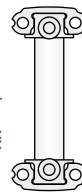
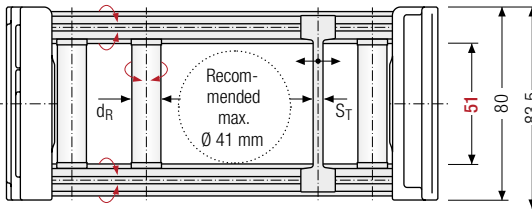

Calculating the cable carrier length

Cable carrier length L_k

$$L_k \approx \frac{L_s}{2} + L_B$$

Cable carrier length L_k rounded to pitch t

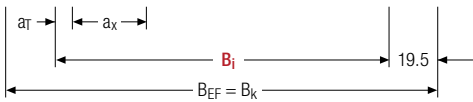

Push-to-connect glide shoes for long travel lengths
 $KR_{min} = 140$ mm

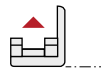

The maximum cable diameter strongly depends on the bending radius and the desired cable type. Please contact us.



For rough environmental conditions, we recommend the use of OFFROAD glide shoes with 80 % higher wear volume.

h_i [mm]	h_G [mm]	h_G' [mm]	h_G' Offroad [mm]	B_i [mm]*	B_k [mm]	B_{EF} [mm]	d_R [mm]	S_T [mm]	a_T min [mm]	a_x min [mm]	KR [mm]	q_k [kg/m]
51	80	83.5	86	75 – 600	$B_i + 39$	$B_i + 39$	10	4	6.5	37	140 170 200 260 290 320 380	3.63 – 6.55

* in 1 mm width sections

Order example



MC0950
Type

400
 B_i [mm]

RMR
Stay variant

200
 KR [mm]

2850
 L_k [mm]

HS
Stay arrangement



Subject to change without notice.

PROTUM®
series

K
series

UNIFLEX
Advanced
series

M
series

XL
series

QUANTUM®
series

TKR
series

TKA
series

UAT
series

Plastic stay RE – screw-in frame stay

- Plastic profile bars for light to medium loads.
Assembly without screws.
- Available customized in **16 mm grid**.
- **Outside/inside:** release by turning by 90°.



Stay arrangement on every
2nd chain link, **standard**
(**HS:** half-stayed)



Stay arrangement on each
chain link (**VS:** fully-stayed)



16 mm B_i 45 – 557 mm
in **16 mm** width sections

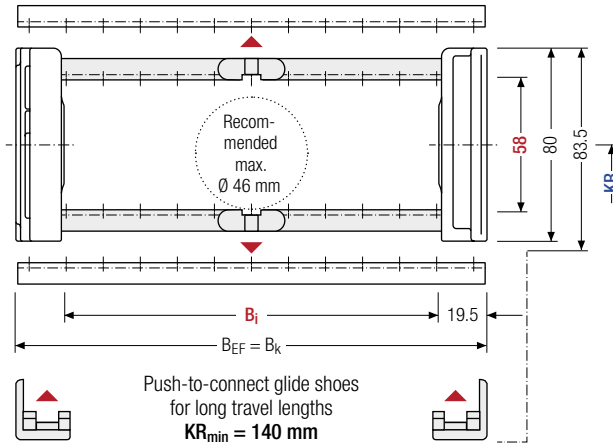

The maximum cable diameter strongly depends on the bending radius and the desired cable type. Please contact us.

For rough environmental conditions, we recommend the use of OFFROAD glide shoes with 80 % higher wear volume.

Calculating the cable carrier length

Cable carrier length L_k

$$L_k \approx \frac{L_S}{2} + L_B$$

Cable carrier length L_k
rounded to pitch t

h _i [mm]	h _G [mm]	h _{G'} [mm]	h _{G'} Offroad [mm]	B _i [mm]						B _k [mm]	B _{EF} [mm]	KR [mm]	q _k [kg/m]			
58	80	83.5	86	45	61	77	93	109	125	141	B _i + 39	B _i + 39	140	170	3.0	
				157	173	189	205	221	237	253			200	260		
				269	285	301	317	333	349	365			290	320		6.2
				381	397	413	429	445	461	477			380			
				493	509	525	541	557								

Order example



ME0950

Type

413

B_i [mm]

RE

Stay variant

200

KR [mm]

2850

L_k [mm]

HS

Stay arrangement

Plastic stay RD – Frame stay with hinge

- Plastic profile bars with hinge for light to medium loads. Assembly without screws.
- Available customized in **16 mm grid**.
- **Outside:** swivable to both sides.
- **Inside:** release by turning by 90°.



 Stay arrangement on every 2nd chain link, **standard** (HS: half-stayed)

 Stay arrangement on each chain link (**VS: fully-stayed**)

 **16 mm** B_i 45 – 557 mm in **16 mm width sections**

PROTUM® series

K series

UNIFLEX Advanced series

M series

XL series

QUANTUM® series

TKR series

TKA series

UAT series

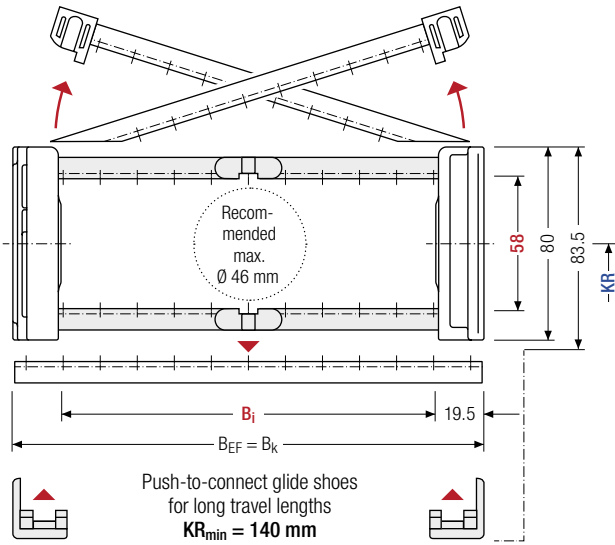

 The maximum cable diameter strongly depends on the bending radius and the desired cable type. Please contact us.

 For rough environmental conditions, we recommend the use of OFFROAD glide shoes with 80 % higher wear volume.

Calculating the cable carrier length

Cable carrier length L_k

$$L_k \approx \frac{L_s}{2} + L_B$$

Cable carrier length L_k rounded to pitch t

h _i [mm]	h _G [mm]	h _{G'} [mm]	h _{G'} Offroad [mm]	B _i [mm]						B _k [mm]	B _{EF} [mm]	KR [mm]	q _k [kg/m]			
58	80	83.5	86	45	61	77	93	109	125	141	B _i + 39	B _i + 39	140	170	3.0	
				157	173	189	205	221	237	253			200	260		
				269	285	301	317	333	349	365			290	320		6.2
				381	397	413	429	445	461	477			380			
				493	509	525	541	557								

Order example

MK0950 Type ·
 413 B_i [mm] ·
 RD Stay variant ·
 200 KR [mm] ·
 2850 L_k [mm] ·
 HS Stay arrangement

Subject to change without notice.

Divider systems

As a standard, the divider system is mounted on each crossbar – for stay mounting on every 2nd chain link (HS).

As a standard, dividers and the complete divider system (dividers with height separations) can be moved in the cross section (**version A**).

The dividers are easily attached to the stay for applications with lateral acceleration and for applications laying on their side by simply turning the frame stay by 180°. The arresting cams click into place in the locking grids in the crossbars (**version B**).

The groove in the frame stay faces outwards.

Divider system TS0 without height separation

Vers.	a_T min [mm]	a_x min [mm]	a_c min [mm]	a_x grid [mm]	n_T min
A	5.5	14.5	8.5	–	–
B	6.5	16	10	16	–

The dividers can be moved within the cross section (version A) or fixed (version B).

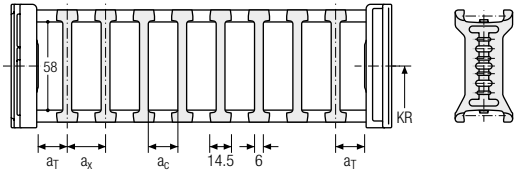

Divider system TS1 with continuous height separation

Vers.	a_T min [mm]	a_T max [mm]	a_x min [mm]	a_c min [mm]	a_x grid [mm]	n_T min
A	5.5	25	14.5	8.5	–	2
B	6.5	25	16	10	16	2

The dividers can be moved within the cross section (version A) or fixed (version B).

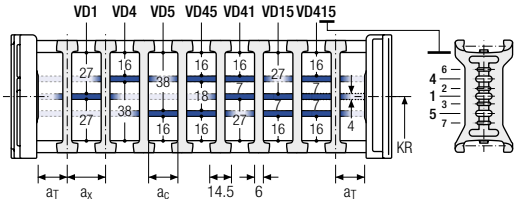

Divider system TS2 with partial height separation

Vers.	a_T min [mm]	a_x min [mm]	a_c min [mm]	a_x grid [mm]	n_T min
A	5.5	14.5/21	8.5/15	–	2
B	6.5	16/32	10/26	16	2

* for VR0

With grid distribution (16 mm grid). The dividers are attached by the height separation, the grid can be moved in the cross section (version A) or fixed (version B).

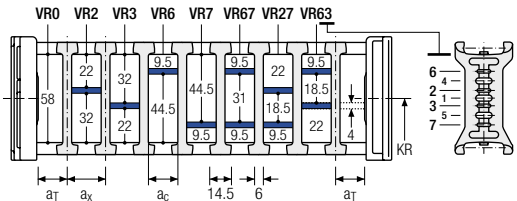

More product information online



Assembly instructions etc.:
Additional info via your
smartphone or check online at
[tsubaki-kabelschlepp.com/
downloads](http://tsubaki-kabelschlepp.com/downloads)



Configure your custom
cable carrier here:
online-engineer.de

Divider system TS3 with height separation made of plastic partitions

Vers.	a _T min [mm]	a _x min [mm]	a _c min [mm]	n _T min
A	4	16 / 42*	8	2

* For aluminum partitions

The dividers are fixed by the partitions, the complete divider system is movable in the cross section.

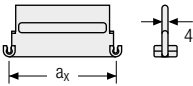
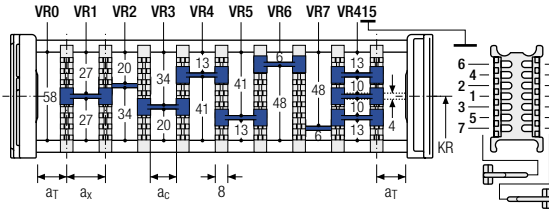

Aluminum partitions in 1 mm increments with a_x > 42 mm are also available.

a _x (center distance of dividers) [mm]											
a _c (nominal width of inner chamber) [mm]											
16	18	23	28	32	33	38	43	48	58	64	68
8	10	15	20	24	25	30	35	40	50	56	60
78	80	88	96	112	128	144	160	176	192	208	
70	72	80	88	104	120	136	152	168	184	200	

When using plastic partitions with a_x > 112 mm, we recommend an additional center support with a twin divider (S_T = 4 mm). Twin dividers are also suitable for retrofitting in the partition system.

Order example

TS3

A

3

K1

34

VR1

⋮
 ⋮
 ⋮

K4

38

VR3

Divider system
Version
n_T
Chamber
a_x
Height separation

Please state the designation of the divider system (TS0, TS1 ...), version and number of dividers per cross section [n_T]. In addition, please also enter the chambers [K] from left to right, as well as the assembly distances [a_T/a_x] (as seen from the driver).

If using divider systems with height separation (TS1, TS3) please also state the positions [e.g. VD23] viewed from the left driver belt. You are welcome to add a sketch to your order.

TOTALTRAX® complete systems

Benefit from the advantages of the TOTALTRAX® complete system. A complete delivery from one source – with a warranty certificate on request! Learn more at tsubaki-kabelschlepp.com/totaltrax

TRAXLINE® cables for cable carriers

Hi-flex electric cables which were especially developed, optimized and tested for use in cable carriers can be found at tsubaki-kabelschlepp.com/traxline

PROTUM® series
K series
UNIFLEX Advanced series
M series
XL series
QUANTUM® series
TKR series
TKA series
UAT series

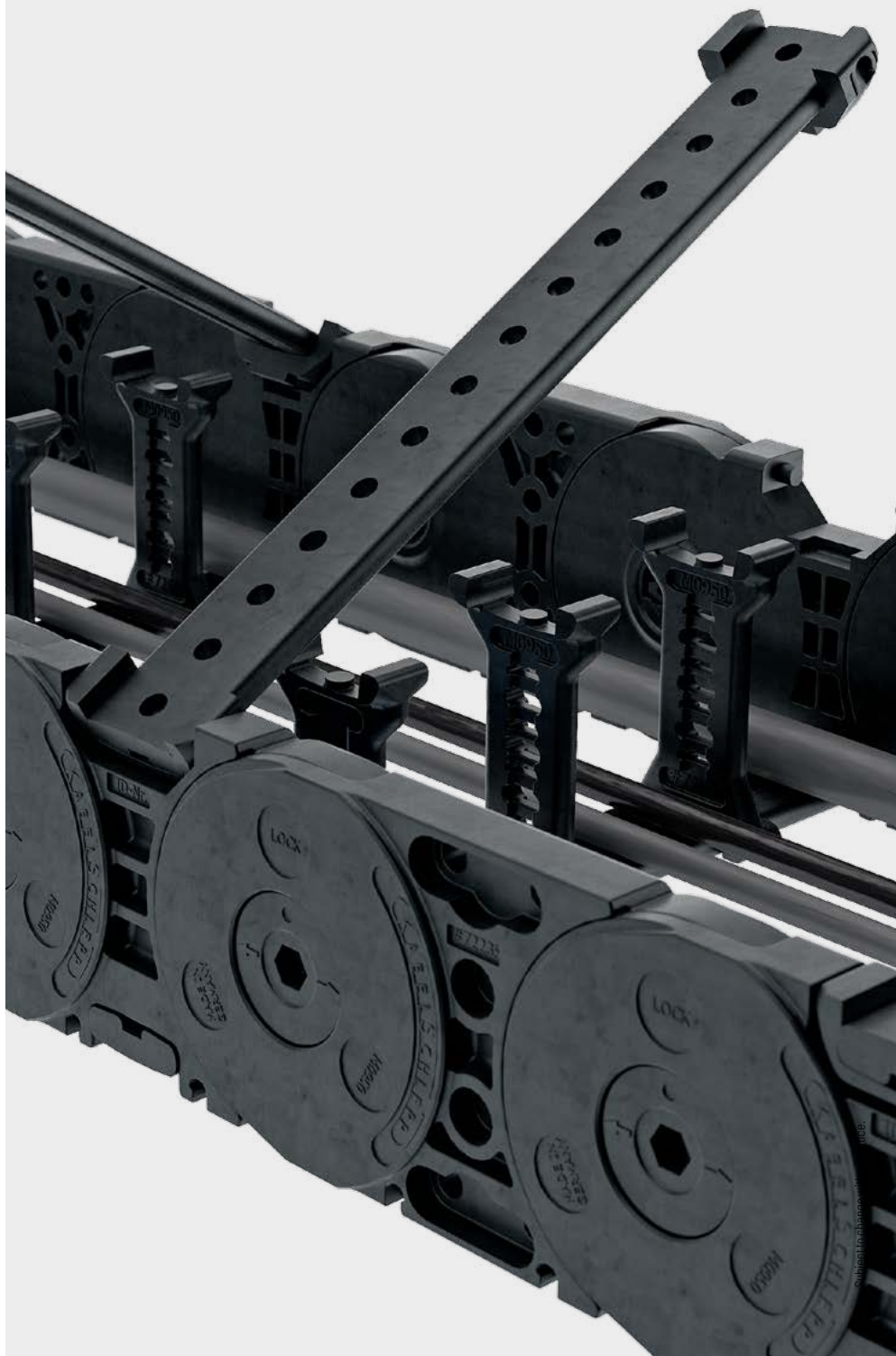
PROTUM®
seriesK
seriesUNIFLEX
Advanced
series**M**
seriesXL
seriesQUANTUM®
seriesTKR
seriesTKA
seriesUAT
series

Universal end connectors UMB – plastic (standard)

The universal mounting brackets (UMB) are made from plastic and can be mounted **from the top, from the bottom, face on or from the side.**

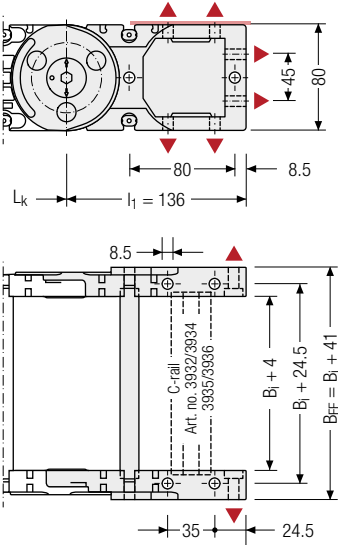

Recommended tightening torque: 27 Nm for cheese-head screws ISO 4762 - M8 - 8.8

End connectors – plastic/steel

Plastic link end connector, steel end connector. The connection variants on the fixed point and on the driver can be combined and, if required, changed afterwards.

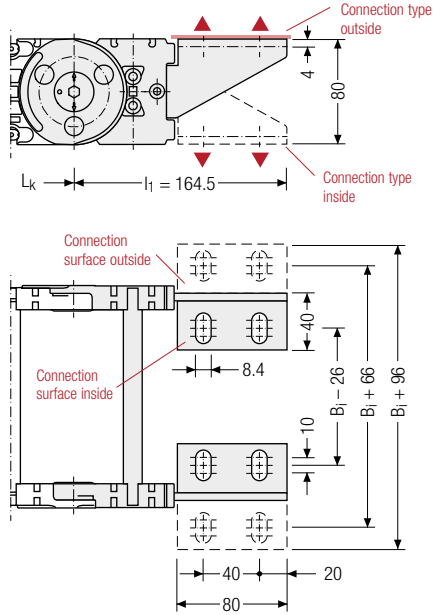

Assembly options

Connection point

- F – fixed point
- M – driver

Connection type

- U – universal mounting bracket

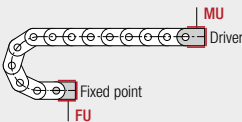

Connection point

- F – fixed point
- M – driver

Connection surface

- I – connection surface inside
- A – connection surface outside

Connection type

- A – threaded joint outside (standard)
- I – threaded joint inside
- F – flange connection

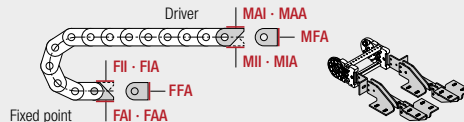

Order example

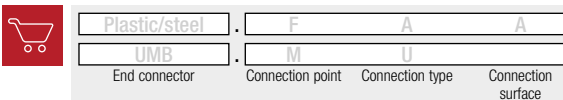

We recommend the use of strain reliefs at the driver and fixed point. See from p. 904.

PROTUM® series
K series
UNIFLEX Advanced series
M series
XL series
QUANTUM® series
TKR series
TKA series
UAT series

M1250

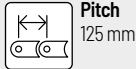

Pitch
125 mm

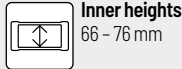

Inner heights
66 – 76 mm



Inner widths
71 – 800 mm

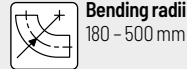

Bending radii
180 – 500 mm

Stay variants

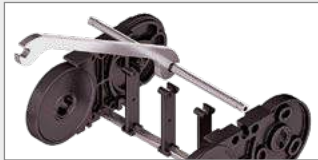

Aluminum stay RS page 418

Frame stay, narrow "The standard"

- » Aluminum profile bars for light to medium loads. Assembly without screws.
- » **Outside/inside:** release by turning by 90°.



Aluminum stay RV page 422

Frame stay, reinforced

- » Aluminum profile bars with plastic adapter for medium to high loads and large cable carrier widths. Assembly without screws.
- » **Outside/inside:** release by turning by 90°.



Aluminum stay RM page 426

Frame stay, solid

- » Aluminum profile bars for heavy loads and maximum cable carrier widths. Double threaded joints on both sides "Heavy Duty".
- » **Inside/outside:** Threaded joint easy to release.



Aluminum stay LG page 428

Hole stay, split version

- » Optimum cable routing in the neutral bending line. Split version for easy cable routing. Stays also available unsplit.
- » **Outside/inside:** Screw-fixing easy to release.

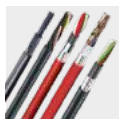

TRAXLINE® cables for cable carriers

Hi-flex electric cables which were specially developed, optimised and tested for use in cable carriers can be found at tsubaki-kabelschlepp.com/traxline.

Stay variants



Aluminum stay RMA page 430

Mounting frame stay

- » Aluminum profile bars with plastic mounting frame stays for guiding very large cable diameters.
- » **Outside/inside:** Screw-fixing easy to release.



Aluminum stay RMR page 432

Frame rolling stay

- » Aluminum profile bars with rotating plastic rolling stay for highest requirements with gentle cable guiding. Double threaded joint on both sides.
- » **Inside/outside:** threaded joint easy to release.



Plastic stay RE page 434

Frame screw-in stay

- » Plastic profile bars for light to medium loads. Assembly without screws.
- » **Outside/inside:** release by turning by 90°.



Plastic stay RD page 435

Frame stay with hinge

- » Plastic profile bars with hinge for light to medium loads. Assembly without screws.
- » **Outside:** swivable to both sides.
- » **Inside:** release by turning by 90°.

Serie MT

Also available as covered variants with cover system.
More information can be found in
chapter "MT series" from p. 612.



PROTUM®
series

K
series

UNIFLEX
Advanced
series

M
series

XL
series

QUANTUM®
series

TKR
series

TKA
series

UAT
series



Unsupported arrangement

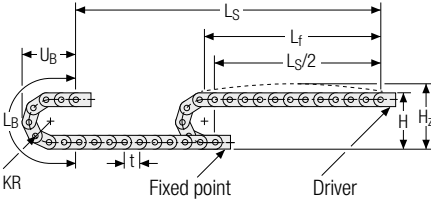

KR [mm]	H [mm]	H _Z [mm]	L _B [mm]	U _B [mm]
180	456	506	816	353
220	536	586	942	393
260	616	666	1067	433
300	696	746	1193	473
340	776	826	1319	513
380	856	906	1444	553
500	1096	1146	1821	673

Load diagram for unsupported length depending on the additional load.

Sagging of the cable carrier is technically permitted for extended travel lengths, depending on the specific application.

Intrinsic cable carrier weight $q_k = 4.5 \text{ kg/m}$. For other inner widths, the maximum additional load changes.

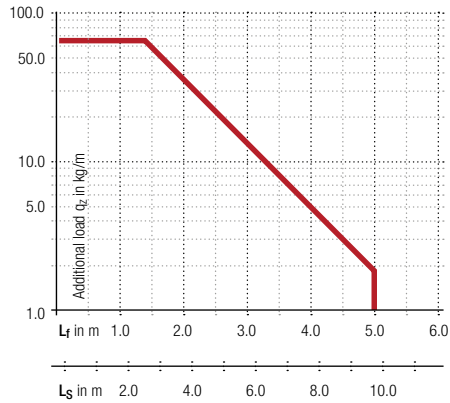

Speed
up to 10 m/s

Acceleration
up to 25 m/s²

Travel length
up to 9.7 m

Additional load
up to 65 kg/m

Gliding arrangement | GO module with chain links optimized for gliding

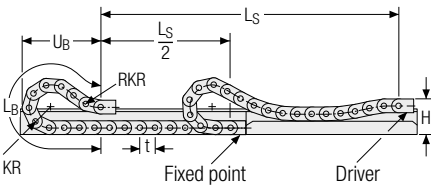

KR [mm]	H [mm]	GO module RKR [mm]	L _B [mm]	U _B [mm]
180	288	500	2000	930
220	288	500	2250	1015
260	288	500	2500	1095
300	288	500	2750	1177
340	288	500	3125	1318
380	288	500	3375	1403
500	288	500	4375	1770

Speed
up to 8 m/s

Acceleration
up to 20 m/s²

Travel length
up to 320 m

Additional load
up to 65 kg/m

The gliding cable carrier must be guided in a channel. See p. 844.

The GO module mounted on the driver is a defined sequence of 4 adapted KR/RKR link plates.

Glide shoes have to be used for gliding applications.

PROTUM® series
K series
UNIFLEX Advanced series
M series
XL series
QUANTUM® series
TKR series
TKA series
UAT series

Aluminum stay RS – frame stay narrow

- Extremely quick to open and close
- Aluminum profile bars for light to medium loads.
Assembly without screws.
- Available customized in **1 mm grid**.
- **Outside/inside:** release by turning by 90°.



Stay arrangement on every
2nd chain link, **standard**
(HS: half-stayed)



Stay arrangement on each
chain link (VS: fully-stayed)



1 mm B_i 75 – 400 mm
in **1 mm width sections**

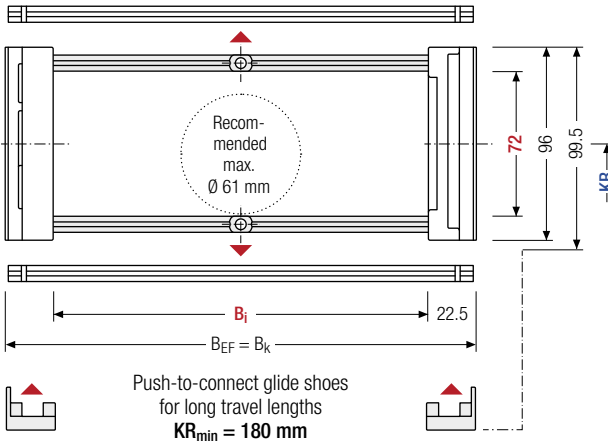

The maximum cable diameter strongly depends on the bending radius and the desired cable type. Please contact us.



For rough environmental conditions, we recommend the use of OFFROAD glide shoes with 80 % higher wear volume.

Calculating the cable carrier length

Cable carrier length L_k

$$L_k \approx \frac{L_s}{2} + L_B$$

Cable carrier length L_k
rounded to pitch t

h _i [mm]	h _G [mm]	h _{G'} [mm]	h _{G'} Offroad [mm]	B _i [mm]*	B _k [mm]	B _{EF} [mm]	KR [mm]		q _k [kg/m]		
72	96	99.5	103	75 – 400	B _i + 45	B _i + 45	180	220	260	300	4.10 – 4.97
							340	380	500		

* in 1 mm width sections

Order example



MC1250

Type

400

B_i [mm]

RS

Stay variant

300

KR [mm]

4250

L_k [mm]

HS

Stay arrangement

Divider systems

As a standard, the divider system is mounted on each crossbar – for stay mounting on every 2nd chain link (HS).

As a standard, dividers and the complete divider system (dividers with height separations) can be moved in the cross section (**version A**).

For applications with lateral acceleration and rotated by 90°, the dividers can be attached by simply clipping on to a socket (available as an accessory).

The bushing additionally serves as a spacer between the dividers and is available in 1 mm sections between 3 – 50 mm (**version B**).

Divider system TSO without height separation

Vers.	a _T min [mm]	a _x min [mm]	a _c min [mm]	n _T min
A	7.5	15	10	2

The dividers can be moved in the cross section.

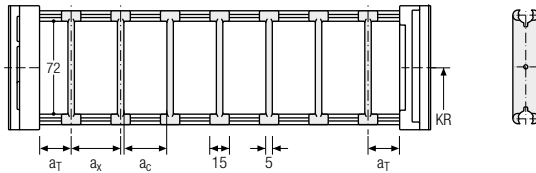

Divider system TS1 with continuous height separation

Vers.	a _T min [mm]	a _T max [mm]	a _x min [mm]	a _c min [mm]	n _T min
A	7.5	25	15	10	2

The dividers can be moved in the cross section.

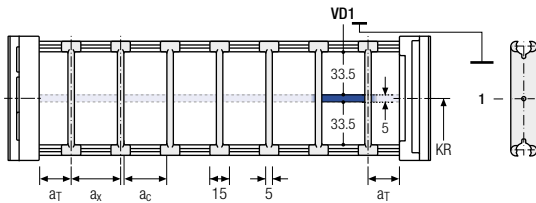

PROTUM® series
K series
UNIFLEX Advanced series
M series
XL series
QUANTUM® series
TKR series
TKA series
UAT series



TOTALTRAX® complete systems

Benefit from the advantages of the TOTALTRAX® complete system. A complete delivery from one source – with a warranty certificate on request! Learn more at tsubaki-kabelschlepp.com/totaltrax



TRAXLINE® cables for cable carriers

Hi-flex electric cables which were especially developed, optimized and tested for use in cable carriers can be found at tsubaki-kabelschlepp.com/traxline

Divider system TS3 with height separation consisting of plastic partitions

As a standard, the divider **version A** is used for vertical partitioning within the cable carrier. The complete divider system can be moved within the cross section.

PROTUM® series

K series

Divider version A

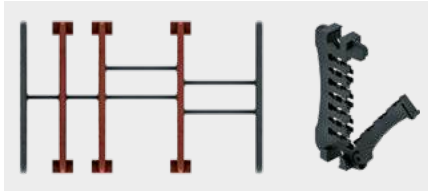

End divider

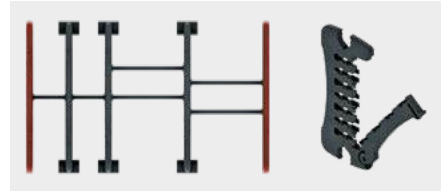

UNIFLEX Advanced series

M series

Vers.	a _T min [mm]	a _x min [mm]	a _c min [mm]	n _T min
A	6/2*	14	10	2

* For End divider

The dividers are fixed by the partitions, the complete divider system is movable in the cross section.

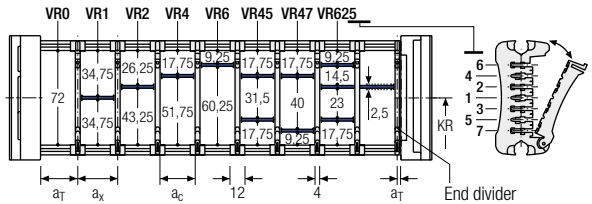

XL series

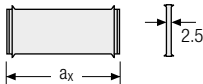

a _x (center distance of dividers) [mm]																
a _c (nominal width of inner chamber) [mm]																
14	16	19	23	24	28	29	32	33	34	38	39	43	44	48	49	54
10	12	15	19	20	24	25	28	29	30	34	35	39	40	44	45	50
58	59	64	68	69	74	78	79	80	84	88	89	94	96	99	112	
54	55	60	64	65	70	74	75	76	80	84	85	90	92	95	108	

When using partitions with a_x > 49 mm we recommended an additional preferential central support.

QUANTUM® series

TKR series

Order example



TS3	A	3	K1	34	VR1
			⋮	⋮	⋮
			K4	38	VR3
Divider system	Version	n _T	Chamber	a _x	Height separation

TKA series

Please state the designation of the divider system (TS0, TS1,...), version and number of dividers per cross section [n_T]. In addition, please also enter the chambers [K] from left to right, as well as the assembly distances [a_T/a_x] (as seen from the driver).

If using divider systems with height separation (TS1, TS3) please also state the positions [e.g. VD23] viewed from the left driver belt. You are welcome to add a sketch to your order.

UAT series

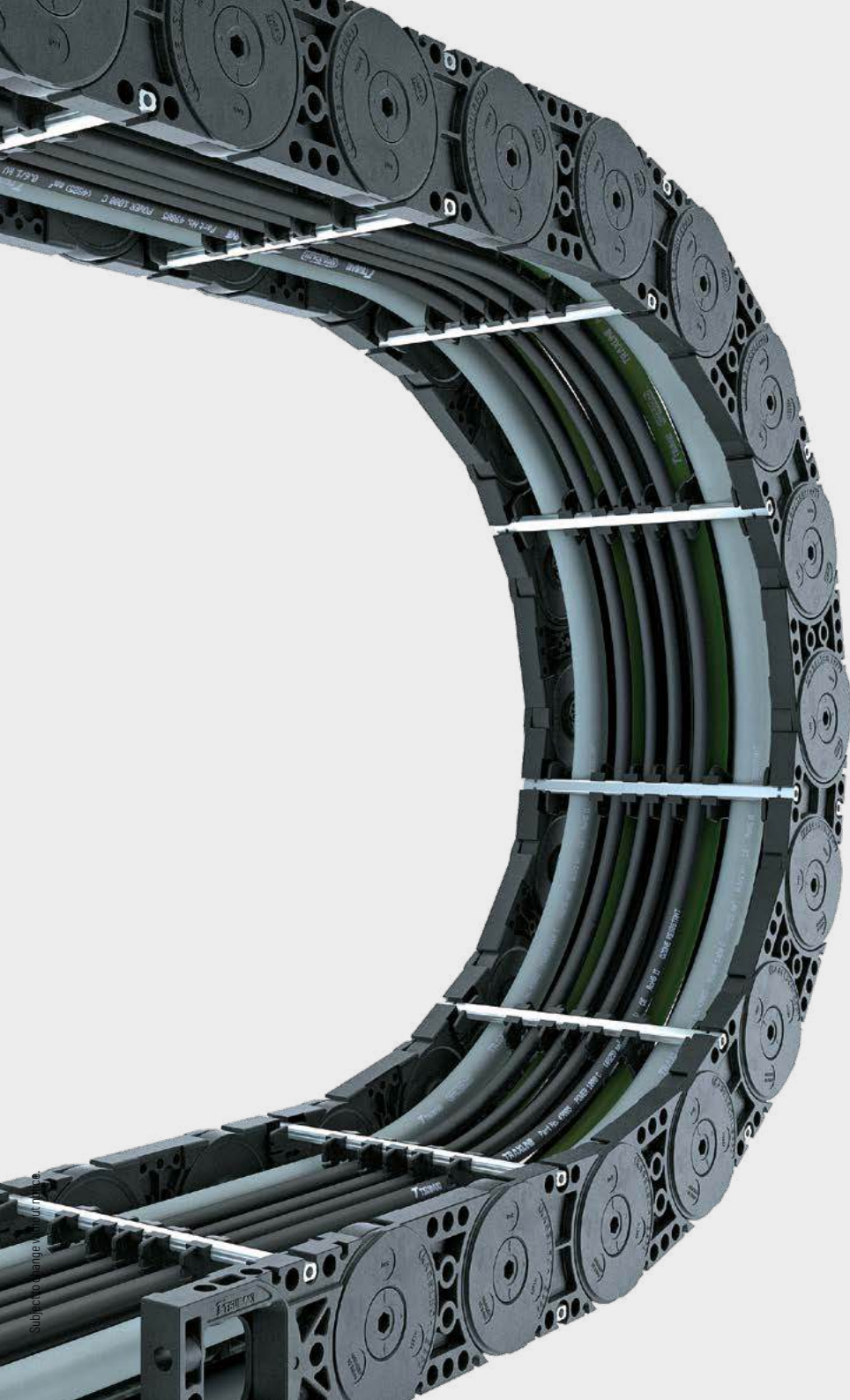

Subject to change without notice.

PROTIUM®
series

K
series

UNIFLEX
Advanced
series

M
series

XL
series

QUANTUM®
series

TKR
series

TKA
series

UAT
series

Aluminum stay RV – frame stay reinforced

- Aluminum profile bars with plastic adapter for medium to high loads and large cable carrier widths. Assembly without screws.
- Available customized in **1 mm grid**.
- **Outside/inside:** release by turning by 90°.



Stay arrangement on every 2nd chain link, **standard** (HS: half-stayed)



Stay arrangement on each chain link (**VS: fully-stayed**)



1 mm B_i 100 – 600 mm in **1 mm width sections**

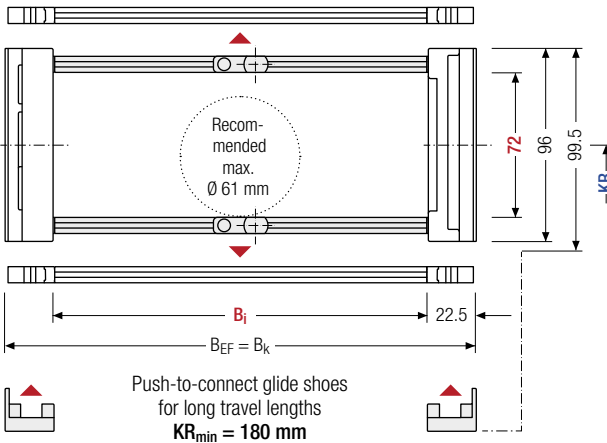

The maximum cable diameter strongly depends on the bending radius and the desired cable type. Please contact us.

For rough environmental conditions, we recommend the use of OFFROAD glide shoes with 80 % higher wear volume.

Calculating the cable carrier length

Cable carrier length L_k

$$L_k \approx \frac{L_s}{2} + L_B$$

Cable carrier length L_k rounded to pitch t

h _i [mm]	h _G [mm]	h _{G'} [mm]	h _{G'} Offroad [mm]	B _i [mm]*	B _k [mm]	B _{EF} [mm]	KR [mm]		q _k [kg/m]			
72	96	99.5	103	100 – 600	B _i + 45	B _i + 45	180	220	260	300	4.40 – 6.18	
							340	380	500			

* in 1 mm width sections

Order example



MC1250

Type

400

B_i [mm]

RV

Stay variant

300

KR [mm]

4250

L_k [mm]

HS

Stay arrangement

Divider systems

As a standard, the divider system is mounted on each crossbar – for stay mounting on every 2nd chain link (HS).

As a standard, dividers and the complete divider system (dividers with height separations) can be moved in the cross section (**version A**).

Divider system TSO without height separation

Vers.	a _T min [mm]	a _x min [mm]	a _c min [mm]	n _T min
A	8	16	10	2

The dividers can be moved in the cross section.

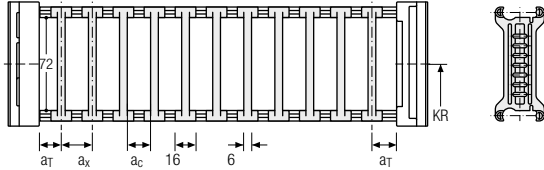

Divider system TS1 with continuous height separation

Vers.	a _T min [mm]	a _T max [mm]	a _x min [mm]	a _c min [mm]	n _T min
A	8	25	16	10	2

The dividers can be moved in the cross section.

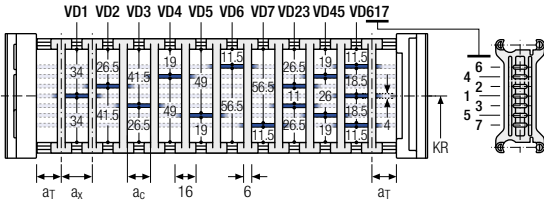

Divider system TS2 with partial height separation

Vers.	a _T min [mm]	a _x min [mm]	a _c min [mm]	n _T min
A	8	21	15	2

With grid distribution (1 mm grid). The dividers are attached by the height separation, the grid can be moved in the cross section.

Sliding dividers are optionally available (thickness of divider = 6 mm).

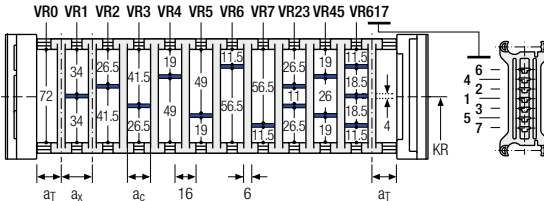

PROTUM® series
K series
UNIFLEX Advanced series
M series
XL series
QUANTUM® series
TKR series
TKA series
UAT series

Subject to change without notice.



TOTALTRAX® complete systems

Benefit from the advantages of the TOTALTRAX® complete system. A complete delivery from one source – with a warranty certificate on request! Learn more at tsubaki-kabelschlepp.com/totaltrax



TRAXLINE® cables for cable carriers

Hi-flex electric cables which were especially developed, optimized and tested for use in cable carriers can be found at tsubaki-kabelschlepp.com/traxline

Divider system TS3 with height separation made of plastic partitions

Vers.	a_T min [mm]	a_x min [mm]	a_c min [mm]	n_T min
A	4	16/42*	8	2

* For aluminum partitions

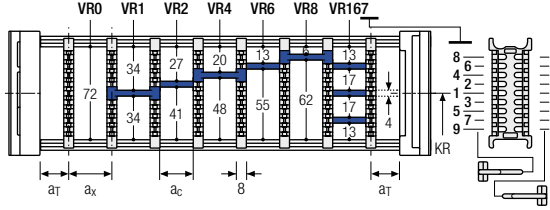

The dividers are fixed by the partitions, the complete divider system is movable in the cross section.

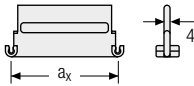

Aluminum partitions in 1 mm increments with $a_x > 42$ mm are also available.

a_x (center distance of dividers) [mm]											
a_c (nominal width of inner chamber) [mm]											
16	18	23	28	32	33	38	43	48	58	64	68
8	10	15	20	24	25	30	35	40	50	56	60
78	80	88	96	112	128	144	160	176	192	208	
70	72	80	88	104	120	136	152	168	184	200	

When using **plastic partitions with $a_x > 112$ mm**, we recommend an additional center support with a **twin divider** ($S_T = 4$ mm). Twin dividers are also suitable for retrofitting in the partition system.

Order example

	TS3	A	3	K1	34	VR1
				⋮	⋮	⋮
			K4	38	VR3	
Divider system	Version	n_T	Chamber	a_x	Height separation	

Please state the designation of the divider system (TS0, TS1 ...), version and number of dividers per cross section n_T . In addition, please also enter the chambers [K] from left to right, as well as the assembly distances $[a_T/a_x]$ (as seen from the driver).

If using divider systems with height separation (TS1, TS3) please also state the positions [e.g. VD23] viewed from the left driver belt. You are welcome to add a sketch to your order.

More product information online



Assembly instructions etc.:
Additional info via your
smartphone or check online at
[tsubaki-kabelschlepp.com/
support](http://tsubaki-kabelschlepp.com/support)



Configure your custom
cable carrier here:
online-engineer.de



UAT
series

TKA
series

TKR
series

QUANTUM®
series

XL
series

M
series

UNIFLEX
Advanced
series

K
series

PROTUM®
series

Aluminum stay RM – frame stay solid

- Aluminum profile bars for heavy loads and maximum cable carrier widths. Double threaded joints on both sides “**Heavy Duty**”.
- Available customized in **1 mm grid**.
- **Inside/outside:** Threaded joint easy to release.

HEAVY DUTY
TSUBAKI KABELSCHLEPP

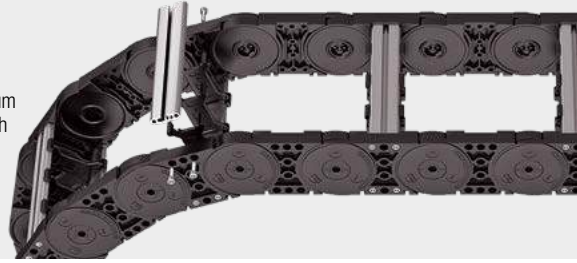

Stay arrangement on every 2nd chain link, **standard** (HS: half-stayed)



Stay arrangement on each chain link (VS: fully-stayed)



1 mm B_i 100 – 800 mm in **1 mm width sections**

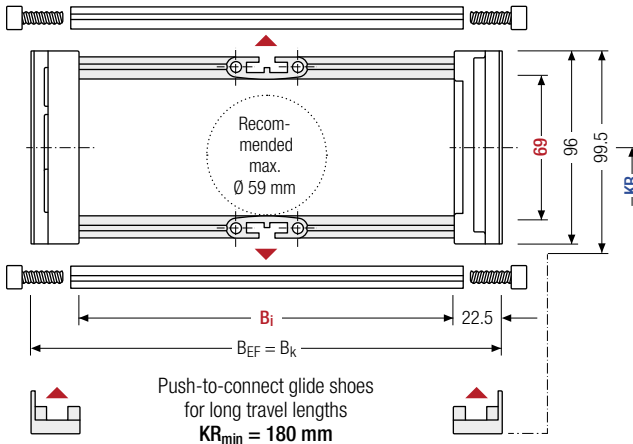

The maximum cable diameter strongly depends on the bending radius and the desired cable type. Please contact us.



For rough environmental conditions, we recommend the use of OFFROAD glide shoes with 80 % higher wear volume.

Calculating the cable carrier length

Cable carrier length L_k

$$L_k \approx \frac{L_s}{2} + L_B$$

Cable carrier length L_k rounded to pitch t

h_i [mm]	h_G [mm]	h_G' [mm]	h_G' Offroad [mm]	B _i [mm]*	B _k [mm]	B _{EF} [mm]	KR [mm]		q _k [kg/m]
69	96	99.5	103	100 – 800	B _i + 45	B _i + 45	180	220	4.14 – 8.48
							340	380	
								500	

* in 1 mm width sections

Order example



MC1250

Type

400

B_i [mm]

RM

Stay variant

300

KR [mm]

4250

L_k [mm]

HS

Stay arrangement

Divider systems

As a standard, the divider system is mounted on each crossbar – for stay mounting on every 2nd chain link (HS).

As a standard, dividers and the complete divider system (dividers with height separations) can be moved in the cross section (**version A**).

Divider system TSO without height separation

Vers.	a _T min [mm]	a _x min [mm]	a _c min [mm]	n _T min
A	10	20	15	–

The dividers can be moved in the cross section.

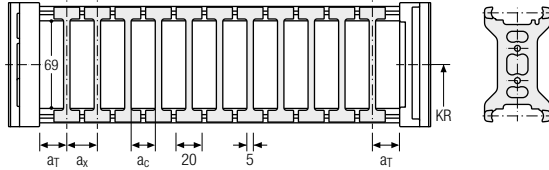

Divider system TS1 with continuous height separation

Vers.	a _T min [mm]	a _T max [mm]	a _x min [mm]	a _c min [mm]	n _T min
A	6	25	12	8	2

The dividers can be moved in the cross section.

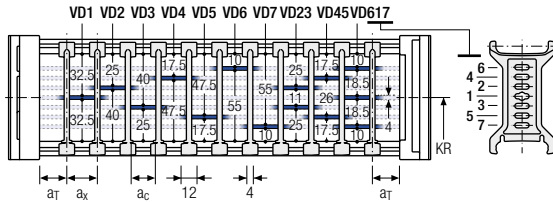

Divider system TS2 with partial height separation

Vers.	a _T min [mm]	a _x min [mm]	a _c min [mm]	n _T min
A	7	21	15	2

With grid distribution (1 mm grid). The dividers are attached by the height separation, the grid can be moved in the cross section.

Sliding dividers are optionally available (thickness of divider = 4 mm).

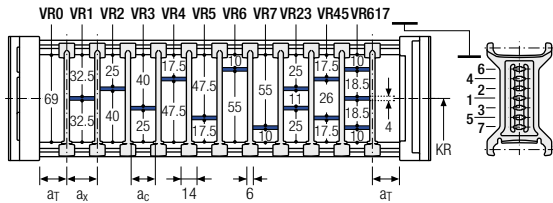

Order example

TS2

A

3

K1

34

VR1

⋮

⋮

⋮

K4

38

VR3

Divider system Version n_T Chamber a_x Height separation

Please state the designation of the divider system (TS0, TS1 ...), version and number of dividers per cross section [n_T]. In addition, please also enter the chambers [K] from left to right, as well as the assembly distances [a_T/a_x] (as seen from the driver).

If using divider systems with height separation (TS1 – TS2) please also state the positions [e.g. VD23] viewed from the left driver belt. You are welcome to add a sketch to your order.

- PROTUM® series
- K series
- UNIFLEX Advanced series
- M series
- XL series
- QUANTUM® series
- TKR series
- TKA series
- UAT series

Aluminum stay LG – Hole stay, split version

- Optimum cable routing in the neutral bending line. Split version for easy cable routing. Stays also available unsplit.
- Available customized in **1 mm width sections**.
- **Outside/inside:** Screw-fixing easy to release.



Stay arrangement on every 2nd chain link, **standard** (HS: half-stayed)



Stay arrangement on each chain link (VS: fully-stayed)



1 mm B_i 100 – 800 mm in **1 mm width sections**

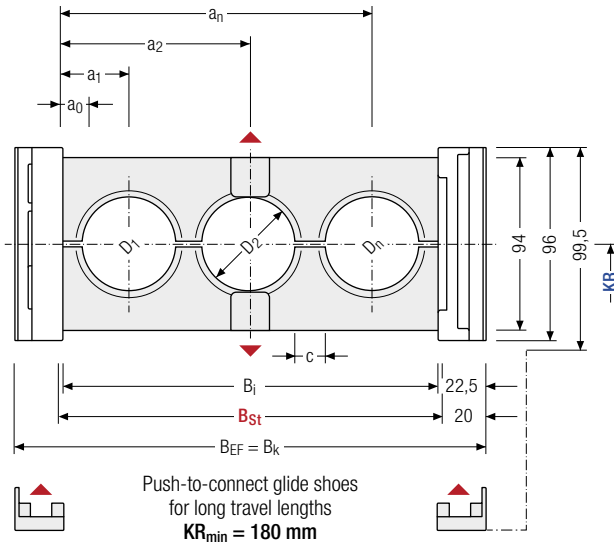

The maximum cable diameter strongly depends on the bending radius and the desired cable type. Please contact us.

Calculating the cable carrier length

Cable carrier length L_k

$$L_k \approx \frac{L_s}{2} + L_B$$

Cable carrier length L_k rounded to pitch t

Calculating the stay width

Stay width B_{St}

$$B_{St} = \sum D + \sum c + 2 a_0$$

D _{max} [mm]	D _{min} [mm]	h _G [mm]	B _i [mm]	B _{St} [mm]*	B _k [mm]	B _{EF} [mm]	c _{min} [mm]	a ₀ min [mm]	KR [mm]	q _k 50 %** [kg/m]
76	12	96	100 – 800	105 – 805	B _{St} + 40	B _{St} + 40	4	12	180 220 260 300 340 380 500	4.75 – 11.17

* in 1 mm width sections

** Hole ratio of the hole stay approx. 50 %

Order example



MC1250

Type

400

B_i [mm]

LG

Stay variant

300

KR [mm]

4250

L_k [mm]

HS

Stay arrangement

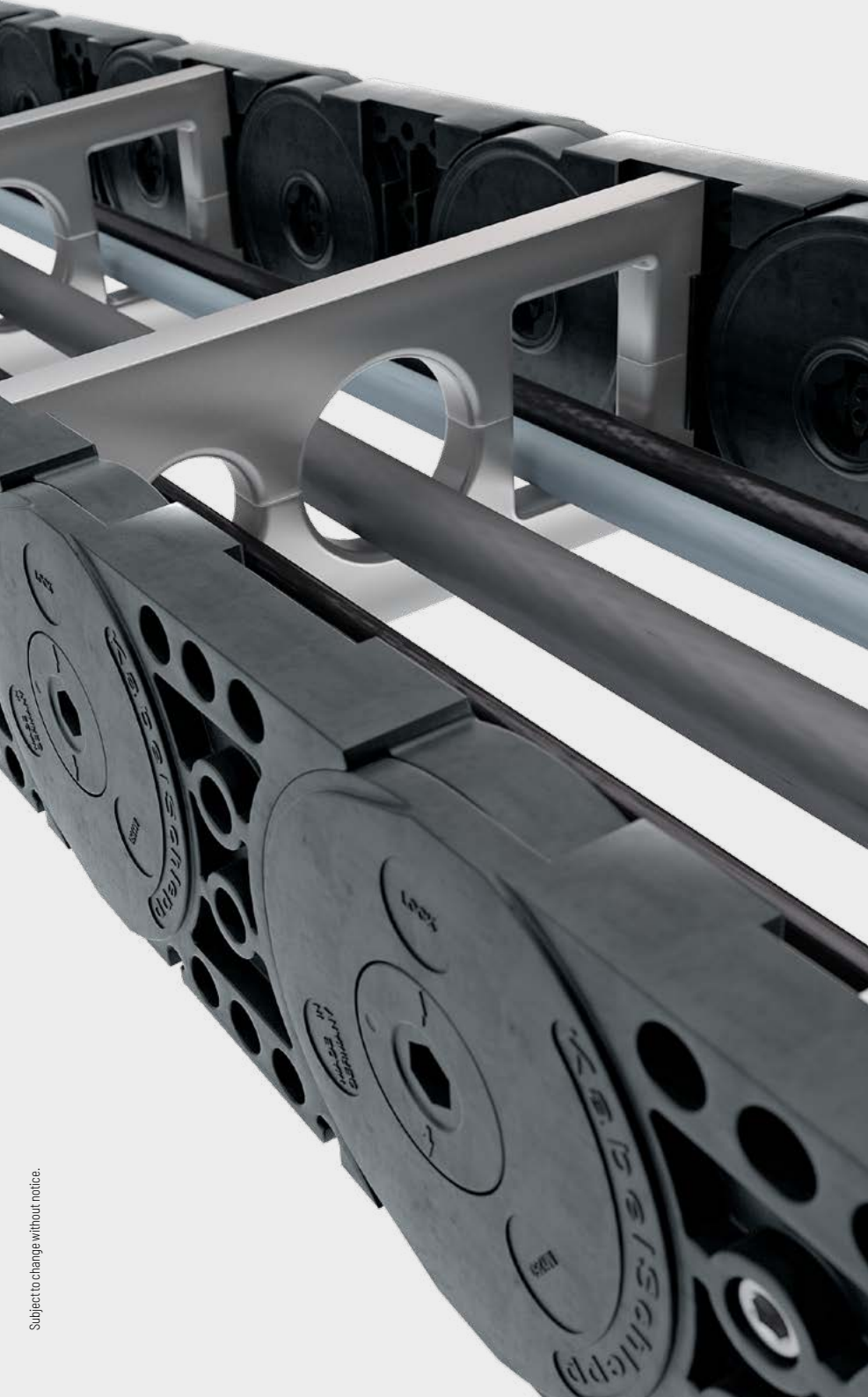

PROTUM®
series

K
series

UNIFLEX
Advanced
series

M
series

XL
series

QUANTUM®
series

TKR
series

TKA
series

UAT
series

Aluminum stay RMA – mounting frame stay

- Aluminum profile bars with plastic mounting frame stays for guiding very large cable diameters.
- The mounting frame stay can be mounted either inside or outside in the bending radius. Available customized in **1 mm width sections**.
- Outside/inside:** Screw-fixing easy to release.



Stay arrangement on every 2nd chain link, **standard** (HS: half-stayed)



Stay arrangement on each chain link (**VS: fully-stayed**)



1 mm B_i 200 – 800 mm in **1 mm width sections**

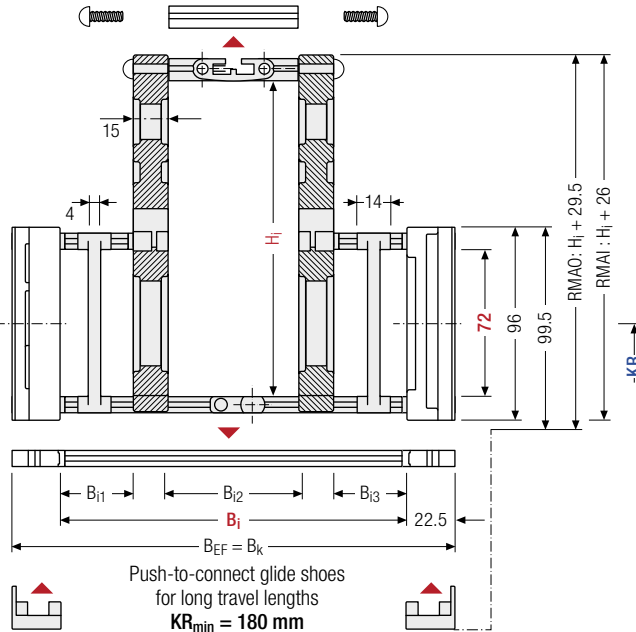

i The maximum cable diameter strongly depends on the bending radius and the desired cable type. Please contact us.

Calculating the cable carrier length

Cable carrier length L_k

$$L_k \approx \frac{L_s}{2} + L_B$$

Cable carrier length L_k rounded to pitch t

i Intrinsic cable carrier weight

Determining the intrinsic cable carrier weight strongly depends on the selected stay arrangement. Please contact us.

h_i [mm]	H_i [mm]	h_G [mm]	B_i [mm]	$B_{i1 \text{ min}}$ [mm]	$B_{i3 \text{ min}}$ [mm]	B_k [mm]	B_{EF} [mm]	KR [mm]			
72	130 160	96	200 – 800	40	40	$B_i + 45$	$B_i + 45$	180	220	260	300
	200							340	380	500	

Order example



MC1250

Type

400

B_i [mm]

RMAO

Stay variant

300

KR [mm]

4250

L_k [mm]

HS

Stay arrangement

Assembly variants

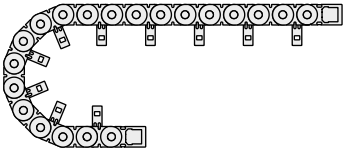

RMAI – assembly to the inside:

Gliding application is not possible when using assembly version RMAI.

Observe minimum KR:

$H_i = 130 \text{ mm}; KR_{\min} = 180 \text{ mm}$

$H_i = 160 \text{ mm}; KR_{\min} = 180 \text{ mm}$

$H_i = 200 \text{ mm}; KR_{\min} = 220 \text{ mm}$

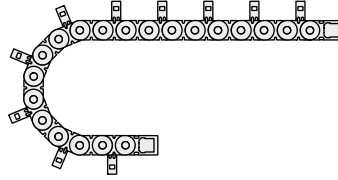

RMAO – assembly to the outside:

The cable carrier has to rest on the side bands and not on the stays.

Guiding in a **channel is required** for support.

Please contact our technical support at technik@kabelschlepp.de to find the corresponding guide channel.

Please note the operating and installation height.



Subject to change without notice.

PROTUM® series
K series
UNIFLEX Advanced series
M series
XL series
QUANTUM® series
TKR series
TKA series
UAT series

Aluminum stay RMR – Frame rolling stay

- Aluminum profile bars with rotating plastic rolling stay for highest requirements with gentle cable guiding. Double threaded joint on both sides.
- Available customized in **1 mm grid**.
- **Inside/outside:** Threaded joint easy to release.

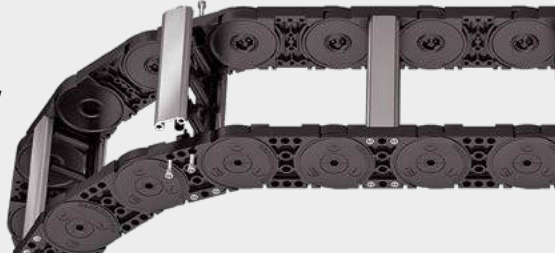

Stay arrangement on every 2nd chain link, **standard** (HS: half-stayed)



Stay arrangement on each chain link (**VS: fully-stayed**)



1 mm B_i 100 – 800 mm in **1 mm** width sections

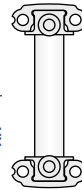
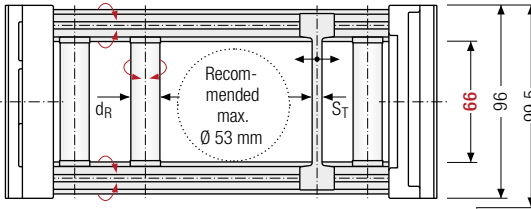

Calculating the cable carrier length

Cable carrier length L_k

$$L_k \approx \frac{L_s}{2} + L_B$$

Cable carrier length L_k rounded to pitch t

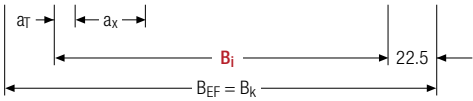

Push-to-connect glide shoes for long travel lengths
KR_{min} = 180 mm



The maximum cable diameter strongly depends on the bending radius and the desired cable type. Please contact us.



For rough environmental conditions, we recommend the use of OFFROAD glide shoes with 80 % higher wear volume.

h _i [mm]	h _G [mm]	h _{G'} [mm]	h _{G'} Offroad [mm]	B _i [mm]*	B _k [mm]	B _{EF} [mm]	d _R [mm]	S _T [mm]	a _T min [mm]	a _x min [mm]	KR [mm]	q _k [kg/m]
66	96	99.5	103	100 – 800	B _i + 45	B _i + 45	10	6	6.5	37	180 220 260 300 340 380 500	4.13 – 8.39

* in 1 mm width sections

Order example

MC1250
Type
400
B_i [mm]
RMR
Stay variant
300
KR [mm]
4250
L_k [mm]
HS
Stay arrangement



Subject to change without notice.

PROTUM®
series

K
series

UNIFLEX
Advanced
series

M
series

XL
series

QUANTUM®
series

TKR
series

TKA
series

UAT
series

Plastic stay RE – screw-in frame stay

- Plastic profile bars for light to medium loads.
Assembly without screws.
- Available customized in **16 mm grid**.
- **Outside/inside:** release by turning by 90°.



Stay arrangement on every
2nd chain link, **standard**
(**HS: half-stayed**)



Stay arrangement on each
chain link (**VS: fully-stayed**)



16 mm B_i 71 – 551 mm
in **16 mm** width sections

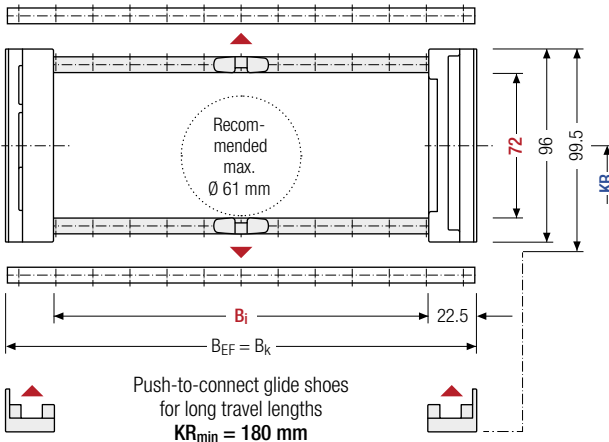

The maximum cable diameter strongly depends on the bending radius and the desired cable type. Please contact us.



For rough environmental conditions, we recommend the use of OFFROAD glide shoes with 80 % higher wear volume.

Calculating the cable carrier length

Cable carrier length L_k

$$L_k \approx \frac{L_s}{2} + L_B$$

Cable carrier length L_k
rounded to pitch t

h _i [mm]	h _G [mm]	h _{G'} [mm]	h _{G'} Offroad [mm]	B _i [mm]					B _K [mm]	B _{EF} [mm]	KR [mm]	q _k [kg/m]			
72	96	99.5	103	71	87	103	119	135	151	167	B _i + 45	B _i + 45	180	220	4.30
				183	199	215	231	247	263	279			260	300	
				295	311	327	343	359	375	391			340	380	
				407	423	439	455	471	487	503			500		
				519	535	551									
												5.80			

Order example



ME1250
Type

407
B_i [mm]

RE
Stay variant

300
KR [mm]

4250
L_k [mm]

HS
Stay arrangement

Plastic stay RD – Frame stay with hinge



- Plastic profile bars with hinge for light to medium loads. Assembly without screws.
- Available customized in **16 mm grid**.
- **Outside:** swivable to both sides.
- **Inside:** release by turning by 90°.

 Stay arrangement on every 2nd chain link, **standard** (HS: half-stayed)

 Stay arrangement on each chain link (**VS: fully-stayed**)

 **16 mm** B_i 71 – 551 mm in **16 mm width sections**

PROTUM® series

K series

UNIFLEX Advanced series

M series

XL series

QUANTUM® series

TKR series

TKA series

UAT series

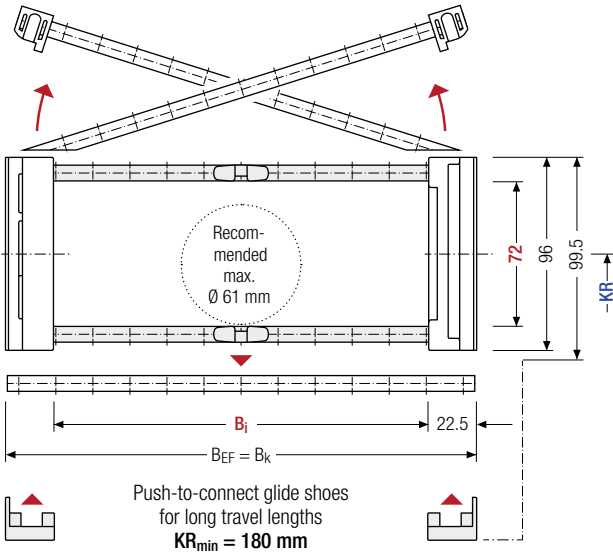

 The maximum cable diameter strongly depends on the bending radius and the desired cable type. Please contact us.

 For rough environmental conditions, we recommend the use of OFFROAD glide shoes with 80 % higher wear volume.

Calculating the cable carrier length

Cable carrier length L_k

$$L_k \approx \frac{L_s}{2} + L_B$$

Cable carrier length L_k rounded to pitch t

h _i [mm]	h _G [mm]	h _{G'} [mm]	h _{G'} Offroad [mm]	B _i [mm]					B _k [mm]	B _{EF} [mm]	KR [mm]	q _k [kg/m]			
72	96	99.5	103	71	87	103	119	135	151	167	B _i + 45	B _i + 45	180	220	4.30 – 5.80
				183	199	215	231	247	263	279			260	300	
				295	311	327	343	359	375	391			340	380	
				407	423	439	455	471	487	503			500		
				519	535	551									

Order example

MK1250 Type ·
 407 B_i [mm] ·
 RD Stay variant ·
 300 KR [mm] ·
 4250 L_k [mm] ·
 HS Stay arrangement

Subject to change without notice.

Divider systems

As a standard, the divider system is mounted on each crossbar – for stay mounting on every 2nd chain link (HS).

As a standard, dividers and the complete divider system (dividers with height separations) can be moved in the cross section (**version A**).

The dividers are easily attached to the stay for applications with lateral acceleration and for applications laying on their side by simply turning the frame stay by 180°. The arresting cams click into place in the locking grids in the crossbars (**version B**).

The groove in the frame stay faces outwards.

Divider system TS0 without height separation

Vers.	a_T min [mm]	a_x min [mm]	a_c min [mm]	a_x grid [mm]	n_T min
A	5	14.5	6.5	—	—
B	19.5	16	8	16	—

The dividers can be moved within the cross section (version A) or fixed (version B).

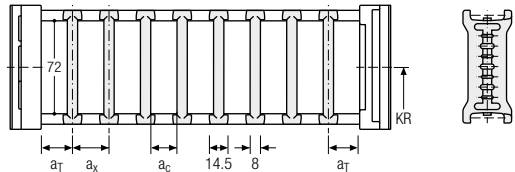

Divider system TS1 with continuous height separation

Vers.	a_T min [mm]	a_T max [mm]	a_x min [mm]	a_c min [mm]	a_x grid [mm]	n_T min
A	5	25	14.5	6.5	—	2
B	19.5	19.5	16	8	16	2

The dividers can be moved within the cross section (version A) or fixed (version B).

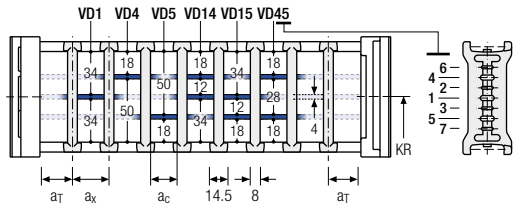

Divider system TS2 with partial height separation

Vers.	a_T min [mm]	a_x min [mm]	a_c min [mm]	a_x grid [mm]	n_T min
A	5	14.5*20	6.5*12	—	2
B	19.5	16*32	8*24	16	2

* for VR0

With grid distribution (**16 mm grid**). The dividers are fixed by the height separation, the complete divider system is movable in the cross section (version A) or fixed (version B).

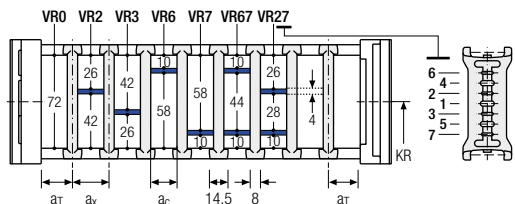

Divider system TS3 with height separation made of plastic partitions

Vers.	a _T min [mm]	a _x min [mm]	a _c min [mm]	n _T min
A	4	16 / 42*	8	2

* For aluminum partitions

The dividers are fixed by the partitions, the complete divider system is movable in the cross section.

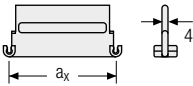
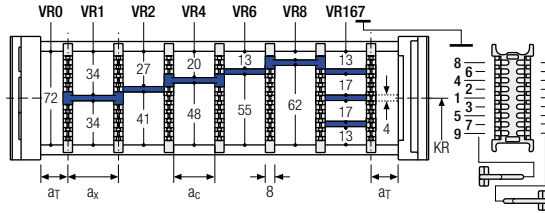

Aluminum partitions in 1 mm increments with **a_x > 42 mm** are also available.

a _x (center distance of dividers) [mm]											
a _c (nominal width of inner chamber) [mm]											
16	18	23	28	32	33	38	43	48	58	64	68
8	10	15	20	24	25	30	35	40	50	56	60
78	80	88	96	112	128	144	160	176	192	208	
70	72	80	88	104	120	136	152	168	184	200	

When using **plastic partitions with a_x > 112 mm**, we recommend an additional center support with a **twin divider** (S_T = 4 mm). Twin dividers are also suitable for retrofitting in the partition system.

Order example

TS3

A

3

K1

34

VR1

⋮
 ⋮
 ⋮

K4

38

VR3

Divider system
Version
n_T
Chamber
a_x
Height separation

Please state the designation of the divider system (**TS0, TS1 ...**), version and number of dividers per cross section [n_T]. In addition, please also enter the chambers [K] from left to right, as well as the assembly distances [a_T/a_x] (as seen from the driver).

If using divider systems with height separation (**TS1, TS3**) please also state the positions [e.g. VD23] viewed from the left driver belt. You are welcome to add a sketch to your order.

More product information online



Assembly instructions etc.: Additional info via your smartphone or check online at tsubaki-kabelschlepp.com/downloads



Configure your custom cable carrier: here online-engineer.de

- PROTUM® series
- K series
- UNIFLEX Advanced series
- M series
- XL series
- QUANTUM® series
- TKR series
- TKA series
- UAT series

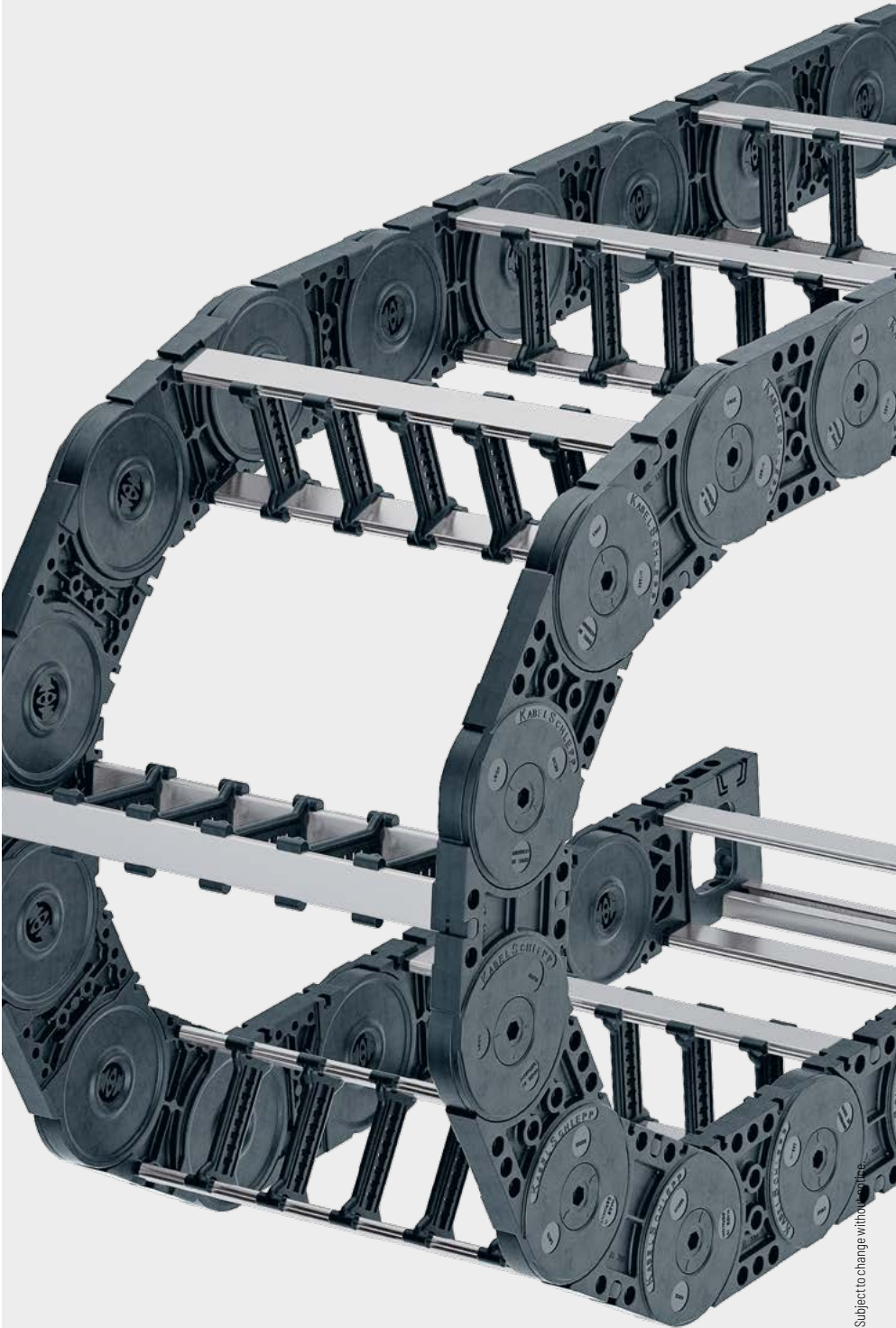
PROTUM®
seriesK
seriesUNIFLEX
Advanced
seriesM
seriesXL
seriesQUANTUM®
seriesTKR
seriesTKA
seriesUAT
series

Universal end connectors UMB – plastic (standard)

The universal mounting brackets (UMB) are made from plastic and can be mounted **from the top, from the bottom, face on or from the side.**

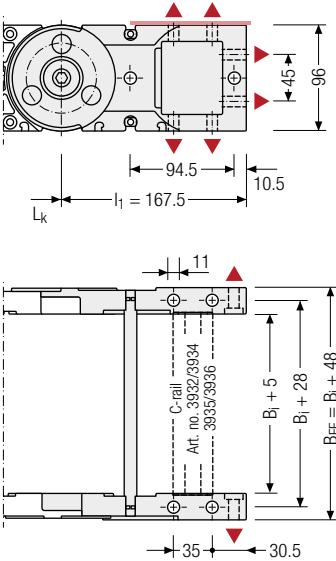

Recommended tightening torque: 54 Nm for cheese-head screws ISO 4762 - M10 - 8.8

End connectors – plastic/steel

Plastic link end connector, steel end connector. The connection variants on the fixed point and on the driver can be combined and, if required, changed afterwards.

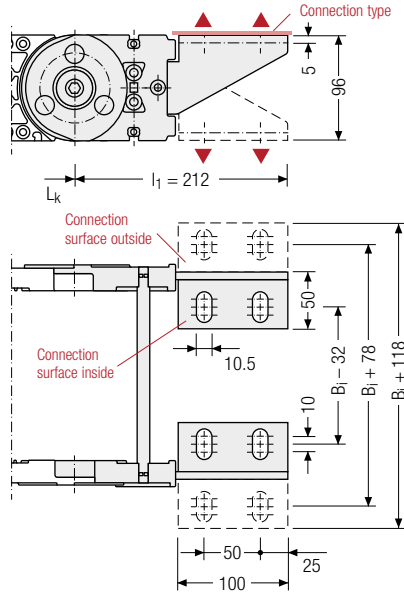

Assembly options

Connection point

- F – fixed point
- M – driver

Connection type

- U – universal mounting bracket

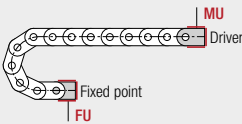

Connection point

- F – fixed point
- M – driver

Connection surface

- I – connection surface inside
- A – connection surface outside

Connection type

- A – threaded joint outside (standard)
- I – threaded joint inside
- F – flange connection

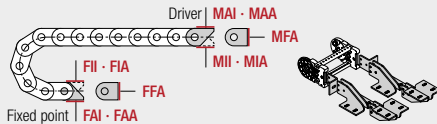

Order example

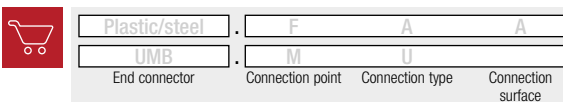

We recommend the use of strain reliefs at the driver and fixed point. See from p. 904.

M1300



Pitch
130 mm



Inner height
87 – 98 mm



Inner widths
100 – 800 mm



Bending radii
150 – 500 mm

Stay variants

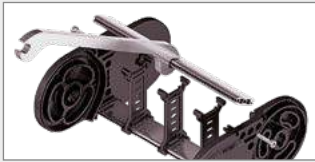

Aluminum stay RMF page 442

Frame stay solid with optional fixing profile

- » Aluminum profile bars for heavy loads and large cable carrier widths. Easy threaded connection.
- » **Inside/outside:** Threaded joint easy to release.

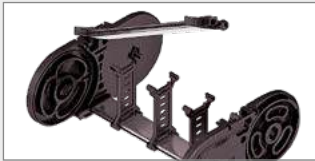

Aluminum stay RMS page 444

Frame stay solid with ball joint

- » Aluminum profile bars with plastic ball joint for heavy loads and large cable carrier widths. Assembly without screws.
- » **Inside/outside:** Swivable and detachable.

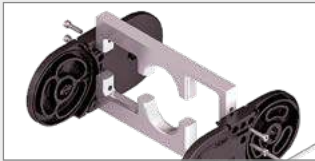

Aluminum stay LG page 446

Hole stay, split version

- » Optimum cable routing in the neutral bending line. Split version for easy cable routing. Stays also available unsplit.
- » **Outside/inside:** Screw-fixing easy to release.

Unsupported arrangement

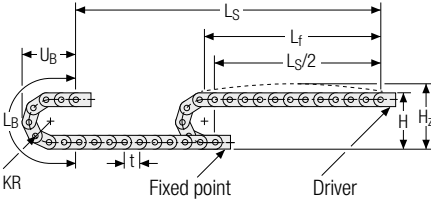

KR [mm]	H [mm]	H _z [mm]	L _B [mm]	U _B [mm]
150	480	540	732	340
195	570	630	873	385
240	660	720	1014	430
280	740	800	1140	470
320	820	880	1266	510
360	900	960	1391	550
400	980	1040	1517	590
500	1180	1240	1831	690

Load diagram for unsupported length depending on the additional load.

Sagging of the cable carrier is technically permitted for extended travel lengths, depending on the specific application.

Intrinsic cable carrier weight $q_k = 8.0 \text{ kg/m}$. For other inner widths, the maximum additional load changes.

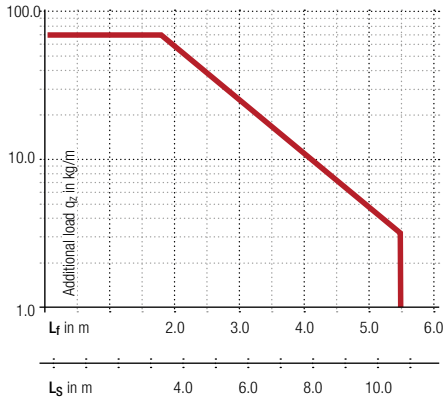

- Speed**
up to 10 m/s
- Acceleration**
up to 25 m/s²
- Travel length**
up to 10.8 m
- Additional load**
up to 70 kg/m

Gliding arrangement | GO module with chain links optimized for gliding

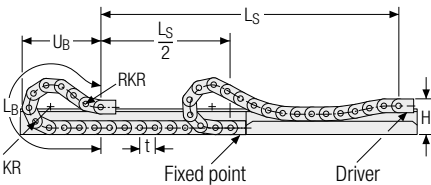

KR [mm]	H [mm]	GO module RKR [mm]	L _B [mm]	U _B [mm]
195	360	500	2210	1040
240	360	500	2470	1125
320	360	500	2880	1240
360	360	500	3140	1331
500	360	500	4310	1756

The cable carrier is to be used gliding only **without pre-tensioning!**

- Speed**
up to 8 m/s
 - Acceleration**
up to 20 m/s²
 - Travel length**
up to 350 m
 - Additional load**
up to 70 kg/m
- The gliding cable carrier must be guided in a channel. See p. 844.
- The GO module mounted on the driver is a defined sequence of 4 adapted KR/RKR link plates.
- Gliding shoes are required for gliding applications.

Subject to change without notice.

Our technical support can provide help for gliding arrangements:
technik@kabelschlepp.de

PROTUM® series

K series

UNIFLEX Advanced series

M series

XL series

QUANTUM® series

TKR series

TKA series

UAT series

Aluminum stay RMF – frame stay solid with optional fixing profile

- Aluminum profile bars for heavy loads and large cable carrier widths. Easy threaded connection.
- Available customized in **1 mm grid**.
- **Inside/outside**: Threaded joint easy to release.

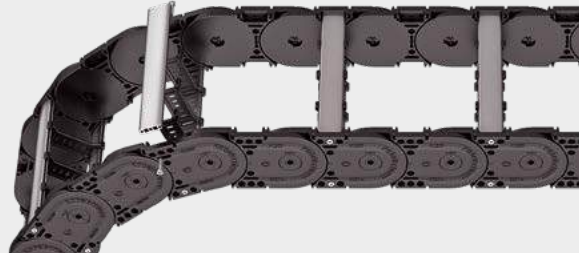

Stay arrangement on every 2nd chain link, **standard** (HS: half-stayed)



Stay arrangement on each chain link (**VS: fully-stayed**)



1 mm B_i 100 – 800 mm in **1 mm** width sections

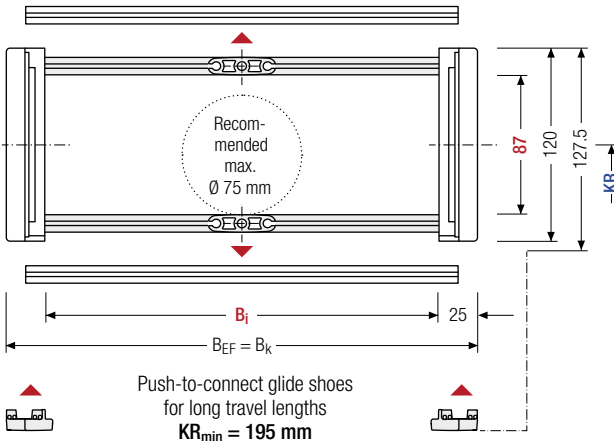

The maximum cable diameter strongly depends on the bending radius and the desired cable type. Please contact us.

Calculating the cable carrier length

Cable carrier length L_k

$$L_k \approx \frac{L_S}{2} + L_B$$

Cable carrier length L_k rounded to pitch t

h_i [mm]	h_G [mm]	h_G' [mm]	B_i [mm]*	B_k [mm]	B_{EF} [mm]	KR [mm]				q_k [kg/m]
87	120	127.5	100 – 800	$B_i + 50$	$B_i + 50$	150	195	240	280	6.24 – 9.59
						320	360	400	500	

* in 1 mm width sections

Order example



MC1300

Type

400

B_i [mm]

RMF

Stay variant

360

KR [mm]

6500

L_k [mm]

HS

Stay arrangement

Divider systems

As a standard, the divider system is mounted on each crossbar – for stay mounting on every 2nd chain link (HS). As a standard, dividers and the complete divider system (dividers with height separations) can be moved in the cross section (**version A**).

For applications with lateral acceleration and lying on the side, the dividers can be attached by simple insertion of a fixing profile into the RMF stay, available as an accessory (**version B**).

Divider system TSO without height separation

Vers.	a _T min [mm]	a _x min [mm]	a _c min [mm]	a _x Raster [mm]	πT min
A	7.5	15	10	–	–
B	10	15	10	5	–

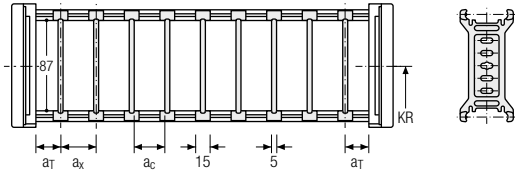

The dividers can be moved within the cross section (version A) or fixed (version B).

Divider system TS1 with continuous height separation

Vers.	a _T min [mm]	a _T max [mm]	a _x min [mm]	a _c min [mm]	a _x Raster [mm]	πT min
A	7.5	25	15	10	–	2
B	10	25	15	10	5	2

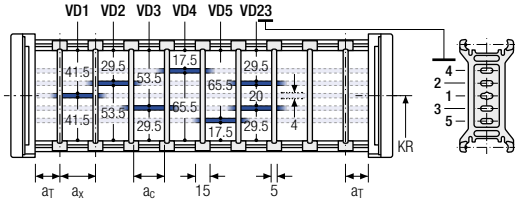

The dividers can be moved within the cross section (version A) or fixed (version B).

Divider system TS3 with partial height separation

Vers.	a _T min [mm]	a _x min [mm]	a _c min [mm]	πT min
A	7.5	16/42*	8	2

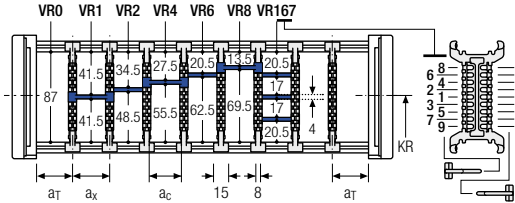

* For aluminum partitions

With grid distribution (1 mm grid). The dividers are attached by the height separation, the grid can be moved in the cross section.

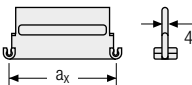

Aluminum partitions in 1 mm increments with a_x > 42 mm are also available.

a _x (center distance of dividers) [mm]											
a _c (nominal width of inner chamber) [mm]											
16	18	23	28	32	33	38	43	48	58	64	68
8	10	15	20	24	25	30	35	40	50	56	60
78	80	88	96	112	128	144	160	176	192	208	
70	72	80	88	104	120	136	152	168	184	200	

When using plastic partitions with a_x > 112 mm, we recommend an additional center support with a twin divider (S_T = 5 mm). Twin dividers are also suitable for retrofitting in the partition system. The height separations VR8 and VR9 are not possible when using twin dividers.

PROTUM® series
K series
UNIFLEX Advanced series
M series
XL series
QUANTUM® series
TKR series
TKA series
UAT series

Aluminum stay RMS – frame stay reinforced

- Aluminum profile bars with plastic ball joint for heavy loads and large cable carrier widths. Assembly without screws.
- Available customized in **1 mm grid**.
- **Inside/outside:** Swivable and detachable.

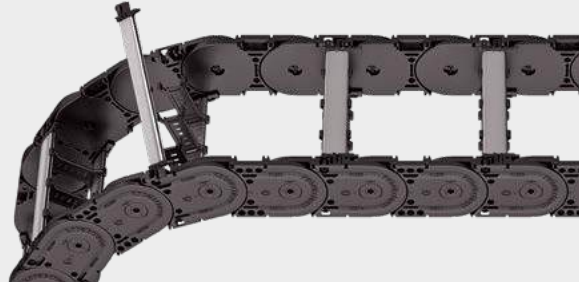

Stay arrangement on every 2nd chain link, **standard (HS: half-stayed)**



Stay arrangement on each chain link (**VS: fully-stayed**)



1 mm B_i 100 – 800 mm in **1 mm width sections**

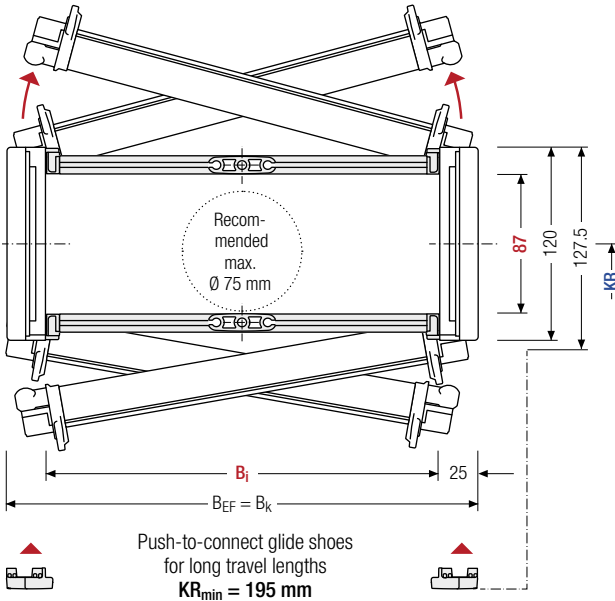

The maximum cable diameter strongly depends on the bending radius and the desired cable type. Please contact us.

Calculating the cable carrier length

Cable carrier length L_k

$$L_k \approx \frac{L_S}{2} + L_B$$

Cable carrier length L_k rounded to pitch t

h_i [mm]	h_G [mm]	h_G' [mm]	B _i [mm]*	B _k [mm]	B _{EF} [mm]	KR [mm]				q _k [kg/m]
87	120	127.5	100 – 800	B _i + 50	B _i + 50	150	195	240	280	6.31 – 9.65
						320	360	400	500	

* in 1 mm width sections

Order example



MC1300

Type

400

B_i [mm]

RMS

Stay variant

360

KR [mm]

6500

L_k [mm]

HS

Stay arrangement

Divider systems

As a standard, the divider system is mounted on each crossbar – for stay mounting on every 2nd chain link (HS). As a standard, dividers and the complete divider system (dividers with height separations) can be moved in the cross section (**version A**).

For applications with lateral acceleration and lying on the side, the dividers can be attached by a fixing profile, available as an accessory (**version B**). The fixing profile must be installed at the factory.

Divider system TS0 without height separation

Vers.	a _T min [mm]	a _x min [mm]	a _c min [mm]	a _x Raster [mm]	π _T min
A	15.5	15	10	–	–
B	18.5	15	10	5	–

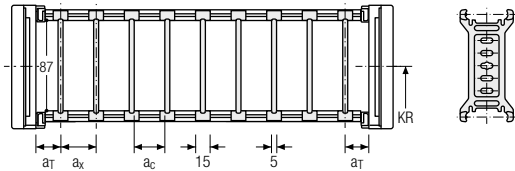

The dividers can be moved within the cross section (version A) or fixed (version B).

Divider system TS1 with continuous height separation

Vers.	a _T min [mm]	a _T max [mm]	a _x min [mm]	a _c min [mm]	a _x Raster [mm]	π _T min
A	15.5	25	15	10	–	2
B	18.5	25	15	10	5	2

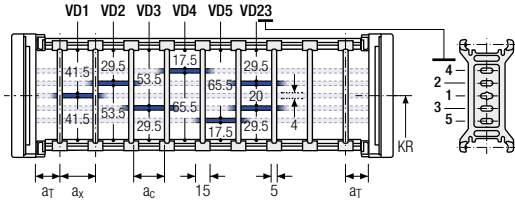

The dividers can be moved within the cross section (version A) or fixed (version B).

Divider system TS3 with partial height separation

Vers.	a _T min [mm]	a _x min [mm]	a _c min [mm]	π _T min
A	15.5	16/42*	8	2

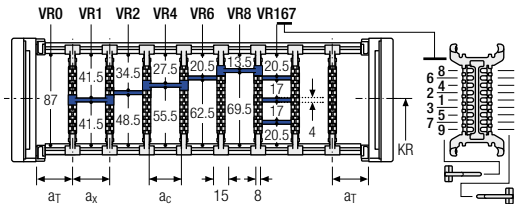

* For aluminum partitions

With grid distribution (1 mm grid). The dividers are attached by the height separation, the grid can be moved in the cross section.

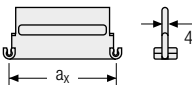

Aluminum partitions in 1 mm increments with a_x > 42 mm are also available.

a _x (center distance of dividers) [mm]											
a _c (nominal width of inner chamber) [mm]											
16	18	23	28	32	33	38	43	48	58	64	68
8	10	15	20	24	25	30	35	40	50	56	60
78	80	88	96	112	128	144	160	176	192	208	
70	72	80	88	104	120	136	152	168	184	200	

When using plastic partitions with a_x > 112 mm, we recommend an additional center support with a twin divider (S_T = 5 mm). Twin dividers are also suitable for retrofitting in the partition system. The height separations VR8 and VR9 are not possible when using twin dividers.

PROTUM® series

K series

UNIFLEX Advanced series

M series

XL series

QUANTUM® series

TKR series

TKA series

UAT series

Aluminum stay LG – Hole stay, split version

- Optimum cable routing in the neutral bending line.
Split version for easy cable routing. Stays also available unsplit.
- Available customized in **1 mm width sections**.
- **Outside/inside:** Screw-fixing easy to release.

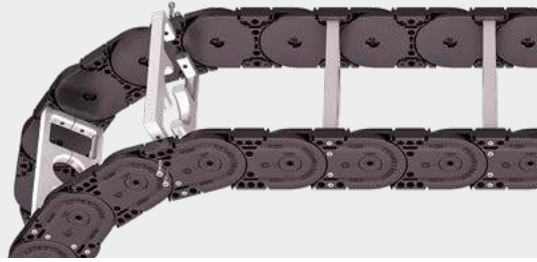

 Stay arrangement on every 2nd chain link, **standard (HS: half-stayed)**

 Stay arrangement on each chain link (**VS: fully-stayed**)

 **1 mm** B_i 100 – 800 mm in **1 mm width sections**

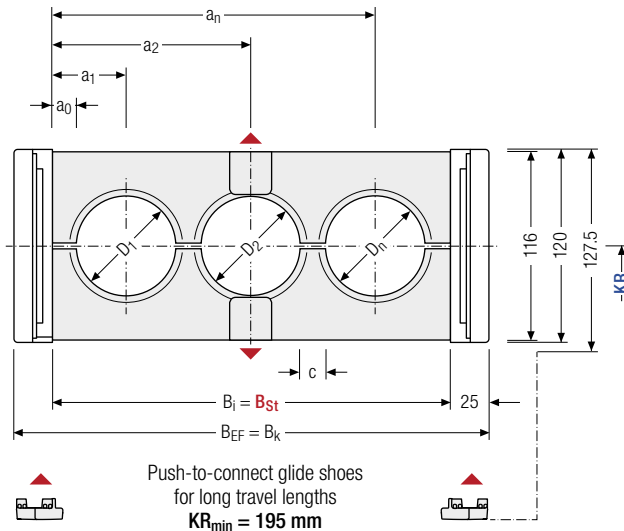

 The maximum cable diameter strongly depends on the bending radius and the desired cable type. Please contact us.

Calculating the cable carrier length

Cable carrier length L_k

$$L_k \approx \frac{L_s}{2} + L_B$$

Cable carrier length L_k rounded to pitch t

Calculating the stay width

Stay width B_{St}

$$B_{St} = \sum D + \sum c + 2 a_0$$

D _{max} [mm]	D _{min} [mm]	h _G [mm]	B _i [mm]	B _{St} [mm]*	B _k [mm]	B _{EF} [mm]	c _{min} [mm]	a _{0 min} [mm]	KR [mm]	q _k 50 %** [kg/m]
98	12	120	100 – 800	100 – 800	B _{St} + 50	B _{St} + 50	4	13	150	7.04
									195	13.53
									240	
									280	
									320	
									400	
									500	

* in 1 mm width sections

** Hole ratio of the hole stay approx. 50 %

Order example

MC1300 Type ·
 400 B_i [mm] ·
 LG Stay variant ·
 360 KR [mm] ·
 6500 L_k [mm] ·
 HS Stay arrangement

Universal end connectors UMB – plastic (standard)

The universal mounting brackets (UMB) are made from plastic and can be mounted **from the top, from the bottom, face on or from the side.**

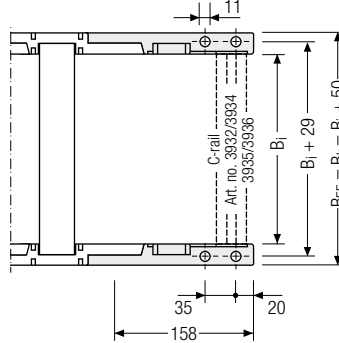
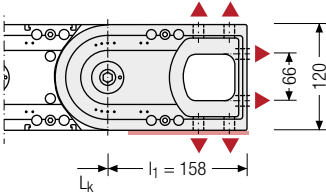

▲ Assembly options

Recommended tightening torque: 54 Nm for cheese-head screws ISO 4762 - M10 - 8.8

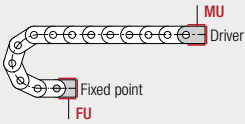

Connection point

F – fixed point
M – driver

Connection type

U – universal mounting bracket

Order example

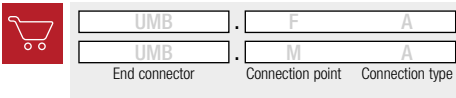

We recommend the use of strain reliefs at the driver and fixed point. See from p. 904.

More product information online



Assembly instructions etc.: Additional info via your smartphone or check online at tsubaki-kabelschlepp.com/downloads



Configure your custom cable carrier here: online-engineer.de