

# TKK series

Dirt-repellent cable carriers  
made of plastic



Trademarks are legally protected for TSUBAKI KABELSCHLEPP GmbH as a national or international registration in the following countries:  
[tsubaki-kabelschlepp.com/Trademarks](http://tsubaki-kabelschlepp.com/Trademarks)

Subject to change.



Inner heights



Inner widths



- 1 Very short steel end connectors
- 2 Plastic chain links
- 3 Extensive unsupported length
- 4 Link system repels dust and chips
- 5 Smooth surface for smooth running
- 6 Inside openable (design 040)
- 7 Dividers and height separations for cable separation

[tsubaki-kabelschlepp.com/tkk](http://tsubaki-kabelschlepp.com/tkk)

## Features

- High torsional rigidity
- Optimised dividers to protect cables: rounded inner and outer profile
- Extensive unsupported length
- New dirt-resistant design of the chain links to protect against dust and chips
- Smooth surface for optimum running
- Closed and openable designs
- Very short end connectors
- Fixable dividers
- Optimised stroke system
- High side stability
- Space-saving design for small spaces

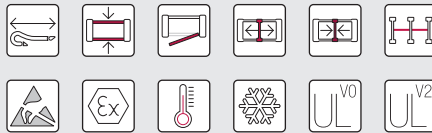

Optimised divider design to protect cables





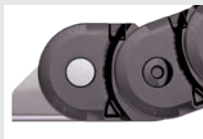











New design of chain links. Link system repels dust, chips and dirt



Very short end connectors

Key for abbreviations  
on page 16Design guidelines  
from page 64Technical support:  
[technik@kabelschlepp.de](mailto:technik@kabelschlepp.de)

Type	Opening variant	Stay variant	$h_i$ [mm]	$h_G$ [mm]	$B_i$ [mm]	$B_k$ [mm]	$B_i$ - grid [mm]	t [mm]	KR [mm]	Additional load ≤ [kg/m]	Cable- $d_{max}$ [mm]
											
<b>TKK39</b>											
		020	39	50	59-99	95	-	39	46-95	10	31
		040	39	50	59-99	95	-	39	46-95	10	31

# TKK series | Overview

Unsupported arrangement			Gliding arrangement			Inner distribution				Installation variants			Page
Travel length $\leq$ [m]	$v_{max}$ $\leq$ [m/s]	$a_{max}$ $\leq$ [m/s <sup>2</sup> ]	Travel length $\leq$ [m]	$v_{max}$ $\leq$ [m/s]	$a_{max}$ $\leq$ [m/s <sup>2</sup> ]	TS0	TS1	TS2	TS3	vertical hanging or standing	lying on the side	rotating arrangement	
4.8	3	9	120	2.5	9	●	●	-	-	●	●	●	202
4.8	3	9	-	-	-	●	●	-	-	●	●	●	203

Inner heights



Inner widths



[tsubaki-kabelschlepp.com/fkk](https://www.tsubaki-kabelschlepp.com/fkk)

# TKK39

Key for abbreviations  
on page 16Pitch  
39 mmInner height  
39 mmInner width  
59 – 99 mmBending radii  
46 – 95 mm

## Stay variants

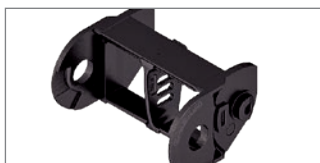

**Design 020** ..... page 202

### Closed frame

- Weight-optimised, closed plastic frame with particularly high torsional rigidity.
- **Outside/inside:** closed.



**Design 040** ..... page 203

### Frame with inside opening crossbar

- Weight-optimised plastic frame with particularly high torsional rigidity.
- Crossbars can be opened at any position on one side.
- **Inside:** openable.

Design guidelines  
from page 64Technical support:  
[technik@kabelschlepp.de](mailto:technik@kabelschlepp.de)

### TRAXLINE® cables for cable carriers

Hi-flex electric cables which were specially developed, optimised and tested for use in cable carriers can be found at [traxline.de](http://traxline.de).

### Additional product information online



Installation instructions, etc.:  
Additional information via your  
smartphone or online at  
[tsubaki-kabelschlepp.com/  
support](http://tsubaki-kabelschlepp.com/support)



Configure your cable carrier here:  
[online-engineer.de](http://online-engineer.de)

Unsupported arrangement

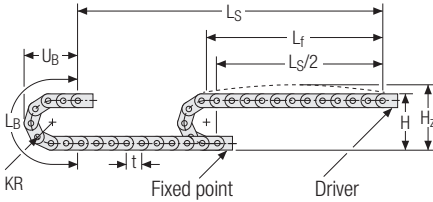

KR [mm]	H [mm]	H <sub>z</sub> [mm]	L <sub>B</sub> [mm]	U <sub>B</sub> [mm]
46	142	172	222	149
58	166	196	260	161
70	190	220	298	173
95	240	270	376	198

Inner heights



Inner widths



Load diagram for unsupported length depending on the additional load.

Sagging of the cable carrier is technically permitted for extended travel lengths, depending on the specific application.

Intrinsic cable carrier weight  $q_k = 1.56 \text{ kg/m}$ . The maximum additional load changes with deviating inner widths.

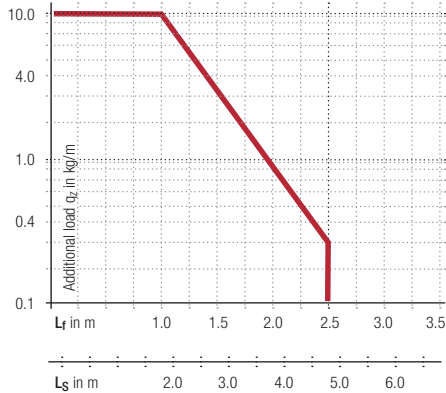

**Speed**  
up to 3 m/s

**Acceleration**  
up to 9 m/s<sup>2</sup>

**Travel length**  
up to 4.8 m

**Additional load**  
up to 10 kg/m

tsubaki-kabelschlepp.com/tkk

Gliding arrangement

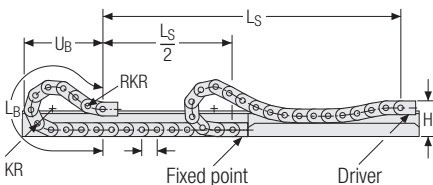

KR [mm]	H [mm]	$n_{RKR}$	L <sub>B</sub> [mm]	U <sub>B</sub> [mm]
46	142	0	222	149
58	150	2	405	196
70	150	3	551	257
95	150	4	770	341

**Speed**  
up to 2.5 m/s

**Acceleration**  
up to 9 m/s<sup>2</sup>

**Travel length**  
up to 120 m

**Additional load**  
up to 10 kg/m

The gliding cable carrier must be guided in a channel. See p. 782.

Glide shoes must be used for gliding applications.

Only design 020 can be used for a gliding arrangement.

Stay variant 020 –  
closed frame

- Weight-optimised, closed plastic frame with particularly high torsional rigidity.
- **Outside/inside:** closed.

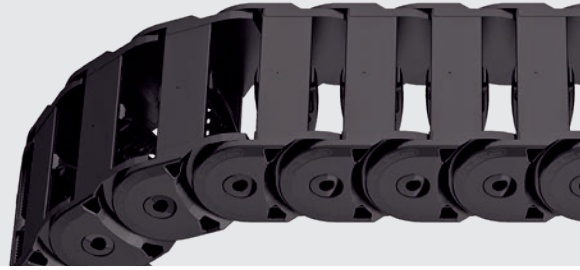
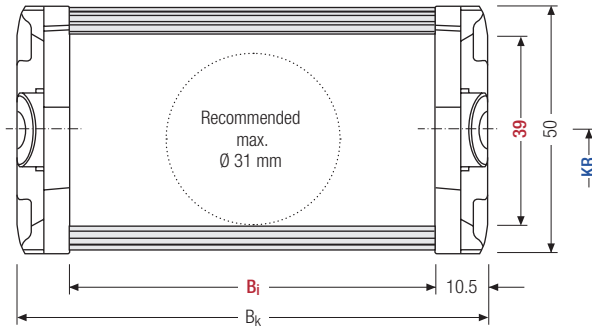
Key for abbreviations  
on page 16Design guidelines  
from page 64Technical support:  
technik@kabelschlepp.deStay arrangement on each  
chain link (**VS: fully-stayed**) $B_i$  59 – 99 mm

The maximum cable diameter strongly depends on the bending radius and the desired cable type. Please contact us.

Calculating the cable  
carrier lengthCable carrier length  $L_k$ 

$$L_k \approx \frac{L_S}{2} + L_B$$

Cable carrier length  $L_k$   
rounded to pitch  $t$

$h_i$ [mm]	$h_G$ [mm]	$B_i$ [mm]	$B_k$ [mm]	$KR$ [mm]	$q_k$ [kg/m]
39	50	59    74    99	$B_i + 21$	46    58    70    95	1.24 – 2.08

## Order example

TKK39  
Type020  
Stay variant74  
 $B_i$  [mm]70  
 $KR$  [mm]- 1950  
 $L_k$  [mm]VS  
Stay arrangement

### Stay variant 040 – with inside opening crossbar

- Weight-optimised plastic frame with particularly high torsional rigidity.
- Crossbars can be opened at any position on one side.
- **Inside:** openable.

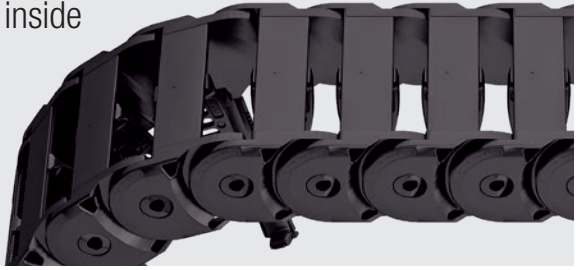

Inner heights



Inner widths



Stay arrangement on each chain link (**VS: fully-stayed**)

$B_i$  59 – 99 mm

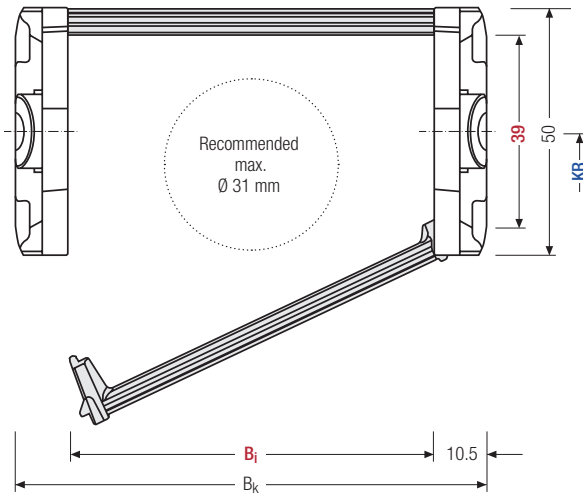

The maximum cable diameter strongly depends on the bending radius and the desired cable type. Please contact us.

#### Calculating the cable carrier length

**Cable carrier length  $L_k$**

$$L_k \approx \frac{L_S}{2} + L_B$$

Cable carrier length  $L_k$  rounded to pitch  $t$

$h_i$ [mm]	$h_G$ [mm]	$B_i$ [mm]	$B_k$ [mm]	$KR$ [mm]	$q_k$ [kg/m]
39	50	59	74	70	1.24 – 2.08
		99	$B_i + 21$	46	
				58	
				70	
				95	

#### Order example

TKK39 · 
 040 · 
 74 · 
 70 · 
 1950 · 
 VS

Type      Stay variant       $B_i$  [mm]       $KR$  [mm]       $L_k$  [mm]      Stay arrangement



### Divider systems

The divider system is mounted on every 2<sup>nd</sup> chain link as a standard.

Dividers, and the complete divider system (dividers with height separations) comes as diameter adjustable as standard (**version A**).

For applications with lateral accelerations and applications with the cable carrier rotated by 90°, the dividers can easily be fixed on the stay.

The arresting cams snap into the catch profiles in the crossbars (**version B**).

### Divider system TS0 without height separation

Vers.	a <sub>T</sub> min [mm]	a <sub>x</sub> min [mm]	a <sub>c</sub> min [mm]	a <sub>x</sub> grid [mm]	n <sub>T</sub> min
A	5	10	7	—	—
B*	5	10	7	2	2

\* not for design 020

The dividers can be moved in the cross section.

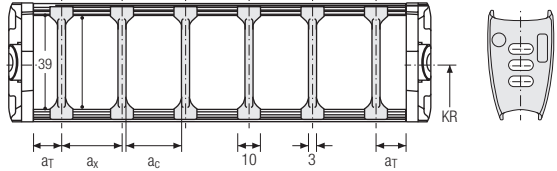

### Divider system TS1 with continuous height separation\*

Vers.	a <sub>T</sub> min [mm]	a <sub>x</sub> min [mm]	a <sub>c</sub> min [mm]	a <sub>x</sub> grid [mm]	n <sub>T</sub> min
A	5	10	7	—	2
B	5	10	7	2	2

\* not for design 020

The dividers can be moved in the cross section.

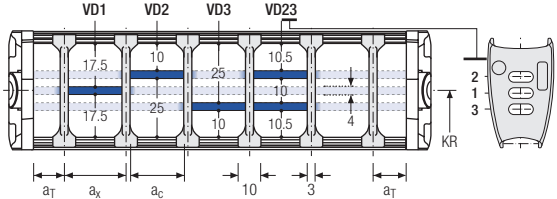

### Order example

TS1 . A . 3 - VD1  
⋮
VD3

Divider system
Version
n<sub>T</sub>
Height separation

Please state the designation of the divider system (**TS0, TS1,...**), the version, and the number of dividers per cross section [n<sub>T</sub>].

When using divider systems with height separation (**TS1**), please additionally state the position (e.g. VD1) viewed from the left driver belt. You are welcome to add a sketch to your order.

## End connectors – steel

The steel end connectors can be connected **from above or below**. The connection type can be changed by altering the position of the end connector.

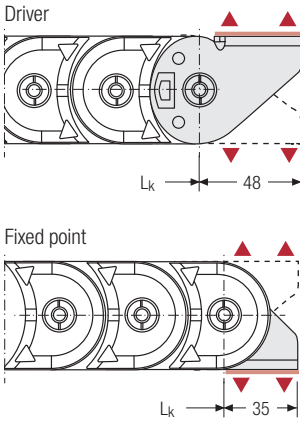

▲ Assembly options

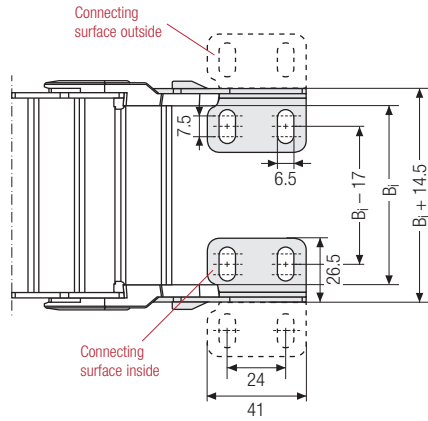

Inner heights



Inner widths



tsubaki-kabelschlepp.com/tkk

### Connection point

- F – fixed point
- M – driver

### Connection type

- I – connecting surface inside
- A – connecting surface outside

### Connecting surface

- A – threaded joint outside (standard)
- I – threaded joint inside

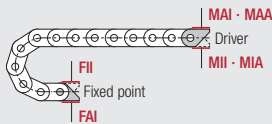

## Order example

	Steel	-	F	A	I
	Steel	-	M	A	I
	End connector		Connection point	Connection type	Connecting surface



We recommend the use of strain reliefs before driver and fixed point. See from p. 834.

## Additional product information online



Installation instructions, etc.:  
Additional info via your smartphone or check online at [tsubaki-kabelschlepp.com/support](http://tsubaki-kabelschlepp.com/support)



Configure your cable carrier here:  
[onlineengineer.de](http://onlineengineer.de)

# BASIC-LINE<sup>PLUS</sup>

## Solid plastic cable carriers with fixed chain widths

The product types from BASIC-LINE PLUS feature pre-defined cable carrier widths and extremely fast cable laying. All combine robustness and reliability with an attractive price-performance ratio.

- Cost-effective solutions for standard applications
- Cables are simply pressed/pulled into the cable carrier
- Very fast cable laying
- Numerous types and designs available immediately from our warehouse
- Ideal for short travel lengths and high travel speeds



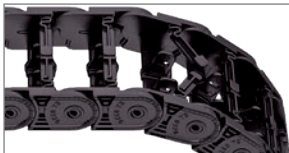
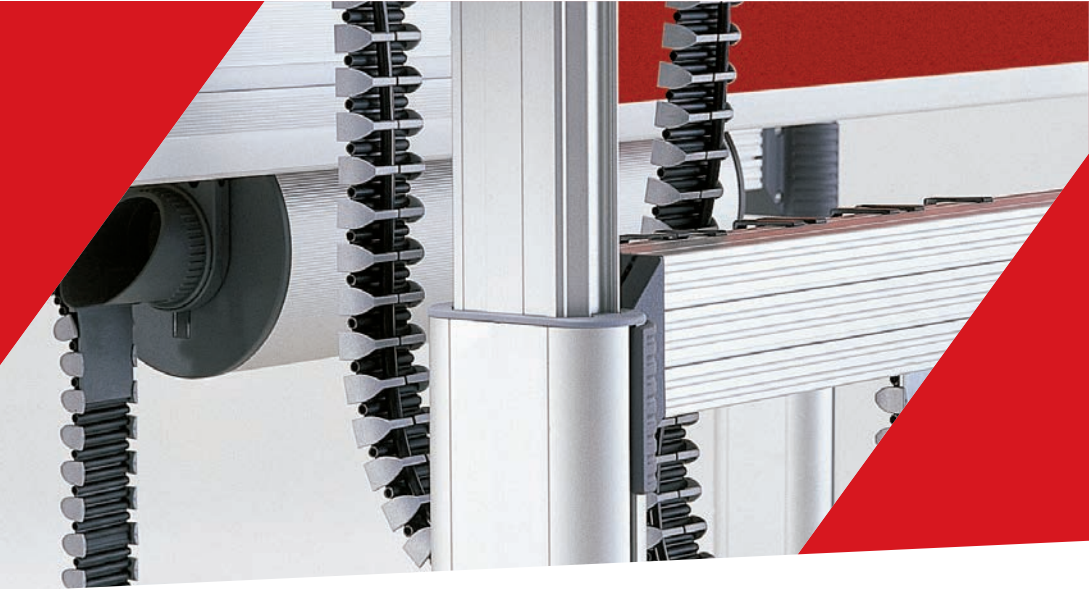

**EasyTrax® series** ..... Page 208

Extremely fast cable laying  
thanks to easy cable insertion



**PROTUM® series** ..... Page 230

Small, light cable carrier  
for unsupported applications