







Support trays and guide channels

Reliable unrolling and optimum gliding for long travel lengths

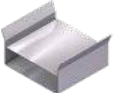

Trademarks are legally protected for the TSUBAKI KABELSCHLEPP GmbH as a national or international registration in the following countries: tsubaki-kabelschlepp.com/trademarks

Subject to change without notice.

Type	One-piece	Multi-piece	Standard length [mm]	Custom length	Material				Easy alignment	Variable width	Flexible distances of the channel mounting	Channel mounting		Channel bottom		Robust design	Page
					StVz	V2A	V4A	Al alloy				inside	outside	open	closed		
Support trays																	
	•	•	2000/ 3000	•	•	•	•	-	•	•	-	•	-	•	•	-	808
Standard channel																	
	•	-	2000/ 3000	•	•	•	•	-	•	-	•	-	•	•	•	•	820
Steel Guide System (TKSG)																	
	-	•	1000/ 2000	-	•	•	•	-	•	•	-	-	•	•	-	•	830
Channel enclosure																	
	-	•	1000/ 2000	-	•	•	•	-	•	•	-	-	•	-	•	•	835
Alu Guide System (TKAL)																	
	-	•	2000	•	-	-	-	•	•	•	•	•	•	•	-	•	836
Easy Guide System (TKEG)																	
	•	•	2000	•	•	•	•	-	•	-	•	-	•	-	•	-	844
Vertical Guide System (TKVG)																	
	-	•	3000	•	-	-	-	•	•	-	•	-	•	-	•	•	864

MT series

XLT series

ROBOTRAX® System

FLATVEYOR®

CLEANVEYOR®

LS/LSX series

S/SX series

S/SX-Tubes series

Accessories

TRAXLINE®

Support trays

An even surface is required for reliable unrolling of the unsupported cable carrier. If this is not already provided on site, a support tray has to be used. If required, we supply our cable carriers with a suitable support tray for your application. This ensures quiet movement of the lower run with reduced wear, reducing costs and design work.

All support trays are available in zinc plated sheet steel or stainless steel. The selection depends on the conditions of use. The simple design allows easy fixing and omits complex individual constructions. The standard lengths are 2000 mm / 3000 mm. Special lengths on request.

MT
seriesXLT
seriesROBOTRAX®
System

FLATVEYOR®

CLEANVEYOR®

LS/LSX
seriesS/SX
seriesS/SX-Tubes
series

Accessories

TRAXLINE®

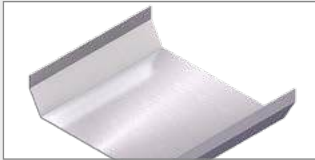

One part (standard) Page 810

Support tray, one part, closed

- Steel profile, folded on both sides.
- Available in zinc plated sheet steel or stainless steel.
- Available for all cable carrier types
- Standard lengths 2000 / 3000 mm, special lengths in 1 mm sections.

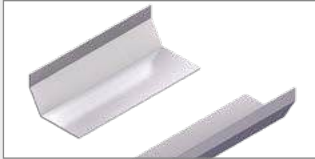

Two parts Page 811

Support tray, two parts, open

- Steel profiles, folded on one side.
- Available in zinc plated sheet steel or stainless steel.
- Available for all cable carrier types.
- Standard lengths 2000 / 3000 mm, special lengths in 1 mm sections.



no change without notice.

TRAXLINE®

Accessories

S/SX-Tubes
series

S/SX
series

LS/LSX
series

CLEANVEYOR®

FLATVEYOR®

ROBOTRAX®
System

XLT
series

MT
series

809

One part – closed (standard)

- Steel profile, folded on both sides.
- Zinc plated sheet steel or stainless steel.
- Available for all cable carrier types.
- Standard lengths 2000 / 3000 mm, special lengths in 1 mm sections.

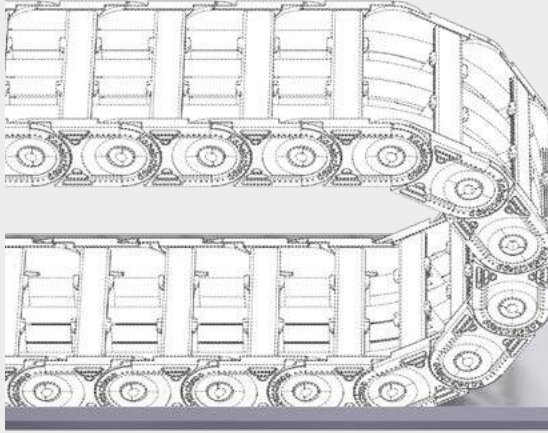

Zinc plated sheet steel / stainless steel



Standard lengths 2000 / 3000 mm
Special lengths on request

LS/SX series

S/SX series

S/SX-Tubes series

Accessories

TRAXLINE®

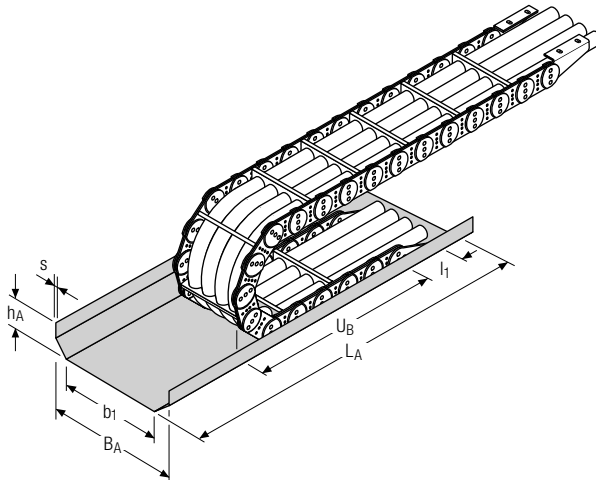

Calculating the support tray length

Support tray length L_A

$$L_A = \frac{L_S}{2} + U_B + l_1$$

(for standard connection)



With upstream strain relief on the fixed point, the support trays have to be made accordingly longer.



The use of a one part support tray depends on the cable carrier. Please contact us.

Two parts – open

- Steel profiles, folded on one side.
- Zinc plated sheet steel or stainless steel.
- Available for all cable carrier types.
- Standard lengths 2000 / 3000 mm, special lengths in 1 mm sections.
- Variable widths.

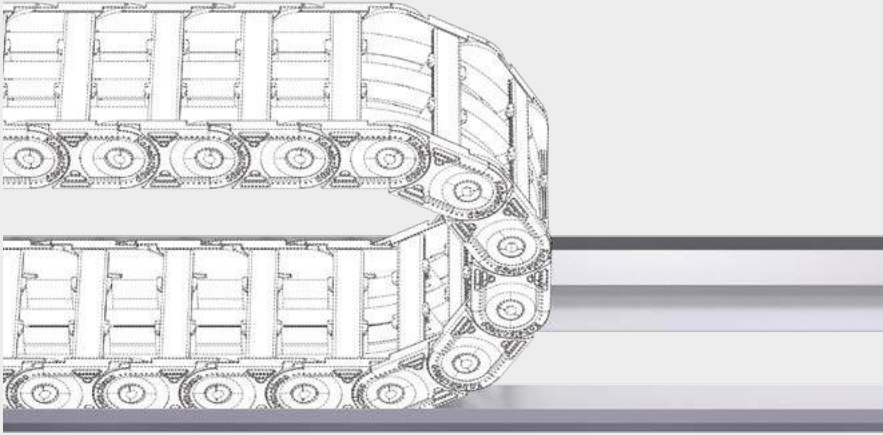

Zinc plated sheet steel / stainless steel



Standard lengths 2000 / 3000 mm
Special lengths on request

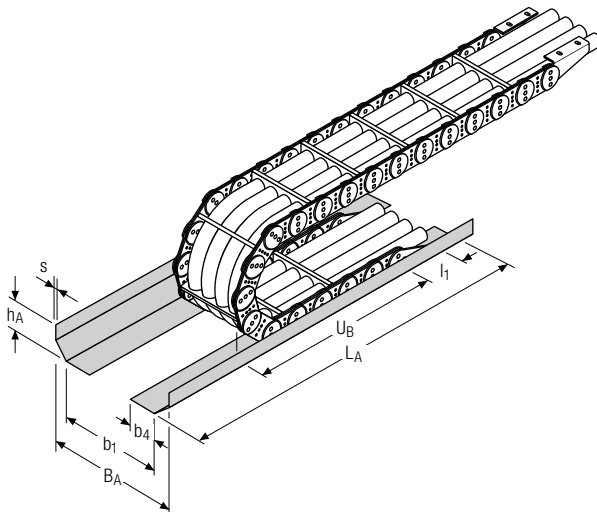

Calculating the support tray length

Support tray length L_A

$$L_A = \frac{L_S}{2} + U_B + l_1$$

(for standard connection)



With upstream strain relief on the fixed point, the support trays have to be made accordingly longer



The use of a two part support tray depends on the the cable carrier. Please contact us.

MT series

XLT series

ROBOTRAX® System

FLATVEYOR®

CLEANVEYOR®

LS/LSX series

S/SX series

S/SX-Tubes series

Accessories

TRAXLINE®

Dimensions

One part – closed (standard)

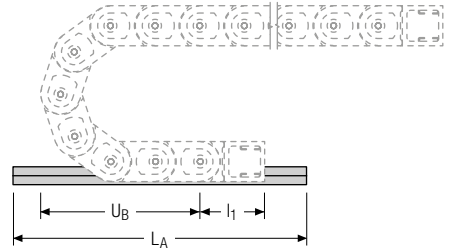
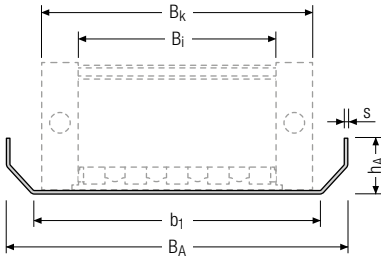

Two parts – open

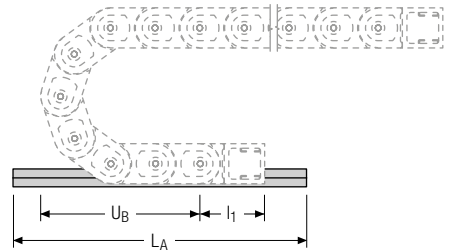
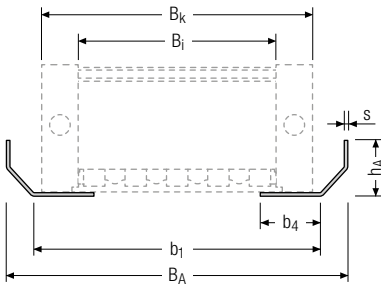

UNIFLEX Advanced series

	B_k [mm]	b_1 [mm]	b_4 [mm]	B_A [mm]	h_A [mm]	s [mm]
UA1455 page 162	$B_i + 16$	$B_k + 6$	25	$B_k + 21$	20	1.5
UA1555 page 172	$B_i + 18$	$B_k + 6$	30	$B_k + 21$	20	1.5
UA1665 page 182	$B_i + 22$	$B_k + 15$	40	$B_k + 40$	30	2
UA1775 page 194	$B_i + 26$	$B_k + 15$	55	$B_k + 40$	30	2
UA1995 page 202/340	$B_i + 30$	$B_k + 20$	60	$B_k + 60$	50	2



The use of a two part support tray strongly depends on the inner width used in the cable carrier. For small inner widths, we recommend using one part support trays. Please contact us.

Dimensions

TKP35 series

B_k [mm]	b_1 [mm]	b_4 [mm]	B_A [mm]	h_A [mm]	s [mm]
TKP35 page 216					
$B_i + 12$	$B_k + 6$	25	$B_k + 21$	20	1.5

EasyTrax® series

B_k [mm]	b_1 [mm]	b_4 [mm]	B_A [mm]	h_A [mm]	s [mm]
ET1455 page 256					
$B_i + 16$	$B_k + 6$	25	$B_k + 21$	20	1.5

K series

B_k [mm]	b_1 [mm]	b_4 [mm]	B_A [mm]	h_A [mm]	s [mm]
K0650 page 304					
$B_i + 28$	$B_k + 15$	40	$B_k + 40$	30	2
K0900 page 318					
$B_i + 31$	$B_k + 15$	55	$B_k + 40$	30	2

M series

B_k [mm]	b_1 [mm]	b_4 [mm]	B_A [mm]	h_A [mm]	s [mm]
M0475 page 364					
$B_i + 17$	$B_k + 6$	30	$B_k + 21$	20	1.5
M0650 page 372					
$B_i + 34$	$B_k + 15$	40	$B_k + 40$	30	2
M0950 page 388					
$B_i + 39$	$B_k + 15$	55	$B_k + 40$	30	2
M1250 page 414					
$B_i + 45$	$B_k + 20$	60	$B_k + 60$	50	3
M1300 page 440					
$B_i + 50$	$B_k + 20$	55	$B_k + 60$	50	3

 MT
series

 XLT
series

 ROBOTRAX®
System

FLATVEYOR®

CLEANVEYOR®

 LS/LSX
series

 S/SX
series

 S/SX-Tubes
series

Accessories

TRAXLINE®

Dimensions

XL series

B_k [mm]	b_1 [mm]	b_4 [mm]	B_A [mm]	h_A [mm]	s [mm]
XL1650 page 480					
$B_i + 68$	$B_k + 20$	70	$B_k + 60$	70	3

QUANTUM® series

B_k [mm]	b_1 [mm]	b_4 [mm]	B_A [mm]	h_A [mm]	s [mm]
Q040 page 490					
$B_i + 40$	$B_k + 6$	30	$B_k + 21$	20	1.5
Q060 page 496					
$B_i + 52$	$B_k + 15$	40	$B_k + 40$	30	2
Q080 page 506					
$B_i + 72$	$B_k + 15$	55	$B_k + 40$	30	2
Q100 page 520					
$B_i + 82$	$B_k + 20$	60	$B_k + 60$	50	3

TKR series

B_k [mm]	b_1 [mm]	b_4 [mm]	B_A [mm]	h_A [mm]	s [mm]
TKR0200 page 544					
$B_i + 16$	$B_k + 6$	25	$B_k + 21$	20	1.5
TKR0260 page 550					
$B_i + 26$	$B_k + 15$	40	$B_k + 40$	30	2
TKR0280 page 556					
$B_i + 30$	$B_k + 15$	40	$B_k + 40$	30	2



The use of a two part support tray strongly depends on the inner width used in the cable carrier. For small inner widths, we recommend using one part support trays. Please contact us.

Dimensions

TKA series

B_k [mm]	b_1 [mm]	b_4 [mm]	B_A [mm]	h_A [mm]	s [mm]
TKA38 page 580					
$B_i + 16$	$B_k + 6$	25	$B_k + 21$	20	1.5
TKA45 page 586					
$B_i + 16$	$B_k + 6$	25	$B_k + 21$	20	1.5
TKA55 page 594					
$B_i + 21$	$B_k + 15$	40	$B_k + 40$	30	2

LS/LSX series

B_k [mm]	b_1 [mm]	b_4 [mm]	B_A [mm]	h_A [mm]	s [mm]
LS/LSX1050 page 700					
$B_{St} + 16/18$	$B_k + 15$	55	$B_k + 40$	30	2

S/SX series

B_k [mm]	b_1 [mm]	b_4 [mm]	B_A [mm]	h_A [mm]	s [mm]
S/SX0650 page 726					
$B_{St} + 15/17$	$B_k + 15$	40	$B_k + 40$	30	2
S/SX0950 page 736					
$B_{St} + 19/21$	$B_k + 15$	55	$B_k + 40$	30	2
S/SX1250 page 748					
$B_{St} + 24/26$	$B_k + 20$	60	$B_k + 60$	50	3
S/SX1800 page 772					
$B_{St} + 29/32$	$B_k + 20$	70	$B_k + 60$	50	3
S/SX2500 page 782					
$B_{St} + 32$	$B_k + 25$	100	$B_k + 75$	80	3
S/SX3200 page 788					
$B_{St} + 40$	$B_k + 25$	100	$B_k + 75$	80	3



We will also be happy to manufacture support trays for types 5000 to 9000. Please contact us.

Order

Support trays

To order the support tray, we need the following information:

- Number of support trays
- Material
- Version of support tray (one part/two parts)
- Part length
- Total length of support tray
- Cable carrier type
- Height of support tray h_A
- Inner width of support tray b_1

Guide channels

Guide channels are important elements for the reliable functioning with long travel lengths. The upper run of the cable carrier slides on the lower run and on the sliding area of the guide channel behind the fixed point. Guide channels prevent the upper run from slipping off the lower

run, ensuring quiet running with low wear. For vertical applications such as elevators or storage and retrieval systems, a vertical channel provides optimum guiding.

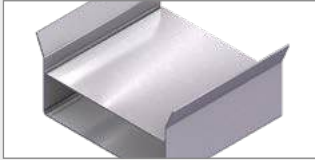

Standard channel..... Page 820

Sheet steel guide channels

- Simple version with customized fixing options.
- Zinc plated sheet steel or stainless steel.
- Standard lengths.



Steel Guide System (TKSG)..... Page 830

Guide channels in the modular system

- Modular system with optimized design for long travel lengths.
- Zinc plated sheet steel or stainless steel.
- Easy installation.



Channel enclosure..... Page 835

Cover for guide channels

- Optimum protection against external influences.
- Easy access for inspection.
- Modular design.



Alu Guide System (TKAL)..... Seite 836

Aluminium guide channels in the modular system

- Modular system with many mounting options.
- Standard lengths and sets.
- Lightweight design for high speeds.



Technical data on p. 818

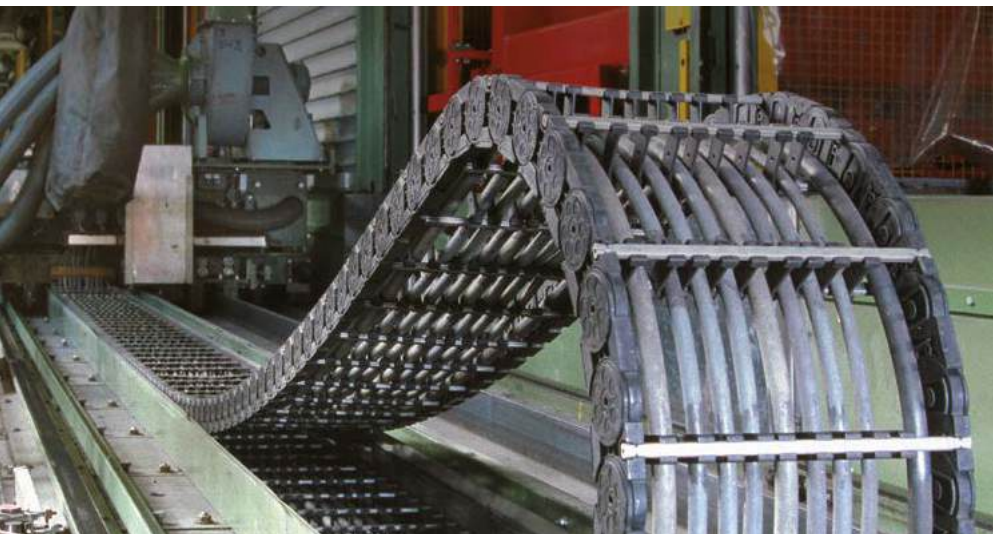

Easy Guide System (TKEG) Page 844

Guide channels for multifunctional use

- Flexible use in many areas of application.
- Made of zinc plated sheet steel or stainless steel.



Vertical Guide System (TKVG) Page 864

Guide channels for vertical hanging applications

- Ready-to-install channel system made of aluminum.
- Standardized module.
- Easy installation.
- For elevators, storage and retrieval systems and many other applications.



Assembly profiles Page 865

Assembly profiles for guide channels

- Assembly profiles with sloping sides can be used for all guide channels for fastening
- Lengths in 50 mm grid possible

MT
seriesXLT
seriesROBOTRAX®
System

FLATVEYOR®

CLEANVEYOR®

LS/LSX
seriesS/SX
seriesS/SX-Tubes
series

Accessories

TRAXLINE®

One-sided arrangement – with lower driver connection and reverse bending radius (standard)

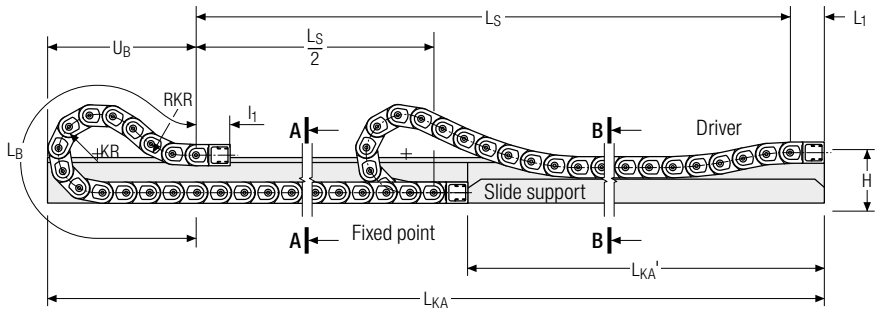

Calculating the channel length

Channel length L_{KA}

$$L_{KA} = L_S + U_B + L_1$$

Calculating the connection height

Connection height H

$$H = 3 h_G$$

Calculating the slide support length

slide support length L_{KA}'

$$L_{KA}' = L_S / 2$$

One-sided arrangement – high connection

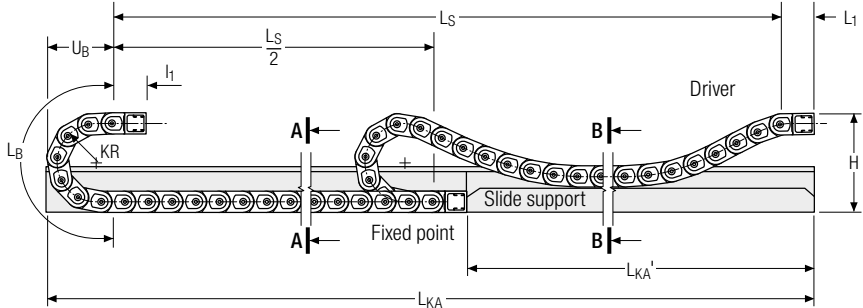

Calculating the channel length

Channel length L_{KA}

$$L_{KA} = L_S + U_B + L_1$$

Connection height high connection

Connection height H

$$H = 2 \times KR + h_G$$

Calculating the slide support length

slide support length L_{KA}'

$$L_{KA}' = L_S / 2$$



TSUBAKI KABELSCHLEPP Technical Support

Increased wear on the cable carrier can occur in applications with a **high driver connection**. Please use our technical support at technik@kabelschlepp.de for the configuration of your application. We will be happy to help you.

Opposite arrangement – with lower driver connection and reverse bending radius (standard)

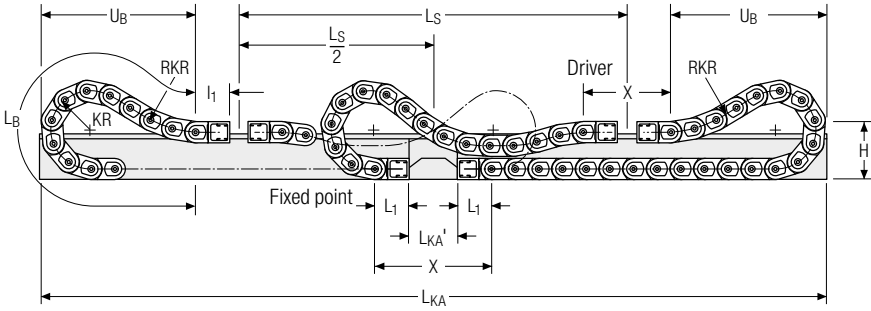

Calculating the channel length

Calculating the connection height

Calculating the slide support length

Channel length L_{KA}

Connection height H

slide support length L_{KA}'

$L_{KA} = L_S + 2 U_B + X$

$H = 3 h_G$

$L_{KA}' = X - 2 L_1$

Opposite arrangement – high connection

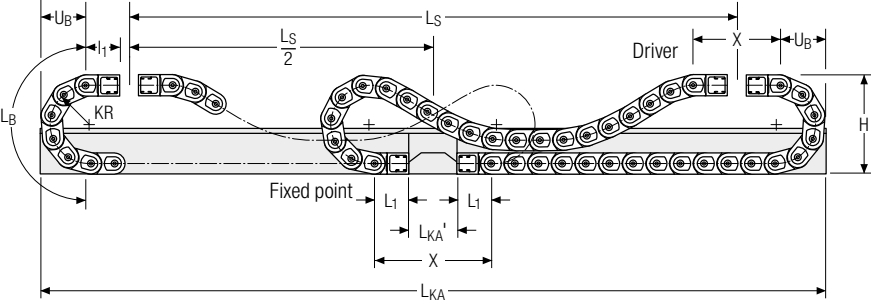

Calculating the channel length

Connection height high connection

Calculating the slide support length

Channel length L_{KA}

Connection height H

slide support length L_{KA}'

$L_{KA} = L_S + 2 U_B + X$

$H = 2 \times KR + h_G$

$L_{KA}' = X - 2 L_1$

i Depending on the chain size, the inner channel width is 4-6 mm larger than the width of the guided cable carrier. Depending on the travel length, the connection height of the cable carrier must be reduced. Please contact us! We will be happy to calculate the suitable guide channel for your application.

i The calculated channel and support lengths are rounded to a reasonable production or installation dimension of the section lengths. A possible travel reserve must be taken into account. Standard section lengths are specified for each channel design.

i For different distances between the fixed points and drivers in your application please contact us.

Subject to change without notice.

MT series
XLT series
ROBOTRAX® System
FLATVEYOR®
CLEANVEYOR®
LS/LSX series
S/SX series
S/SX-Tubes series
Accessories
TRAXLINE®

Sheet steel guide channels

- Simple version with customized fixing options.
- Zinc plated sheet steel or stainless steel.
- Standard lengths.

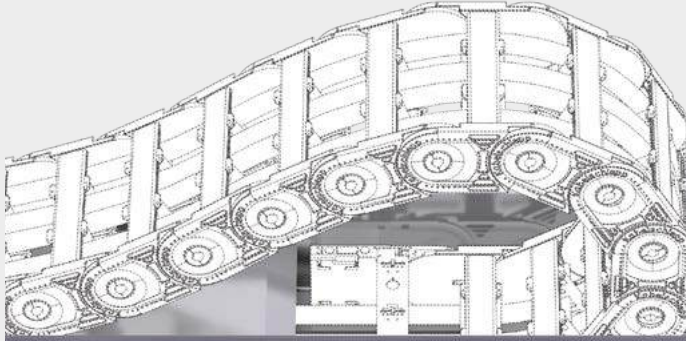

Zinc plated sheet steel /
stainless steel



Standard lengths 2000 / 3000 mm
Special lengths on request

Features

- Universal installation – the channel side walls do not require aligning as there are no single side walls
- Large support widths through sturdy U-design
- Optionally available as a corrosion resistant, sea water resistant version
- Easy fixing options:
 - standard angle brackets for screwing
 - welded on directly on site
 - different fixing variants

Individual solutions

We can also manufacture customized sheet steel guide channels for your application, taking into account virtually any request regarding customized shapes and fixing options.



Information on dimensions can be found from p. 822

MT
seriesXLT
seriesROBOTRAX®
System

FLATVEYOR®

CLEANVEYOR®

LS/LSX
seriesS/SX
seriesS/SX-Tubes
series

Accessories

TRAXLINE®

One-sided arrangement

For one-sided arrangement of the cable carrier, the cable carrier slides behind the fixed point on a continuous slide support with run-on bevels.

Closed design

One part channel closed at the bottom and one part slide support with run-on bevels.



Open design

One part channel closed at the bottom and divided slide support with run-on bevels.

Dirt and liquids can drop through without restrictions.



Opposite arrangement

For opposite arrangement, a slide support is also attached for bridging between the fixed point connections.

Closed design

One part channel closed at the bottom and one part slide support with run-on bevels.

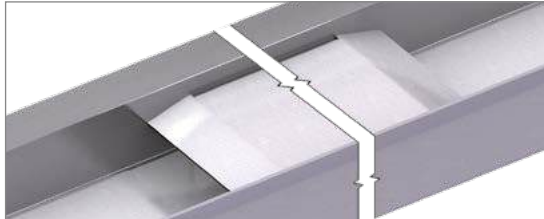

Open design

One part channel closed at the bottom and divided slide support with run-on bevels.

Dirt and liquids can drop through without restrictions.

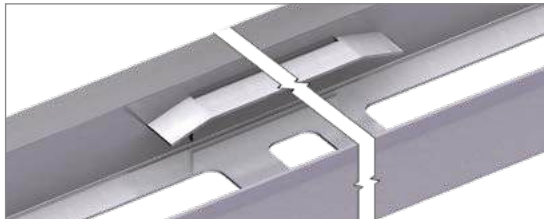

 A special slide support can be adhered to reduce sliding resistance and abrasion between cable carrier and support. We recommend the use of special slide supports for velocities > 0.5 m/s and for frequent move cycles.

Dimensions

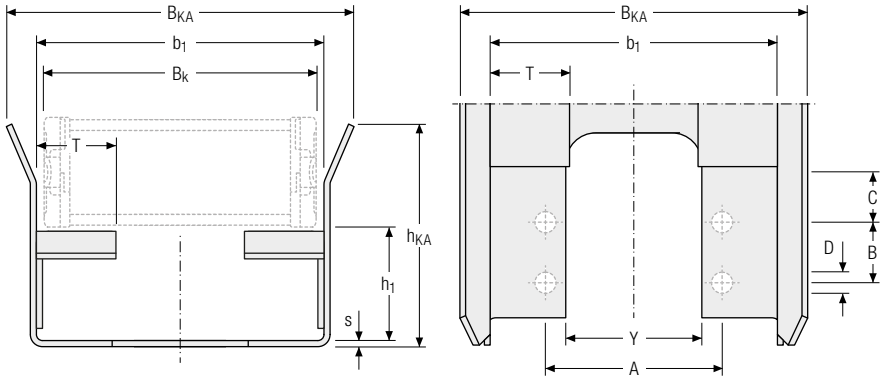

 From $h_{kA} \geq 200$ mm, the guide channel flanks are additionally stabilized with alignment flanges or with connecting flanges.

 The dimension y refers only to open guide channel versions.

UNIFLEX *Advanced* series

Type	h_1 [mm]	h_{kA} [mm]	b_1 [mm]	B_{kA} [mm]	s [mm]	A [mm]	B [mm]	C [mm]	D [mm]	T^* [mm]	Y^{**} [mm]
UA1455 page 162											
-	36	70 (KR < 100)	$B_k + 4$	$B_k + 24$	2	$b_1 - 34.0$ (FA-A)	-	40	6.2	30	$b_1 - 65$
		125 (KR \geq 100)	$B_k + 7$			$b_1 - 34.5$ (FA-L)					
Glide shoes	38.5	70 (KR < 100)	$B_k + 7$	$B_k + 27$	2	$b_1 - 37.0$ (FA-A)	-	40	6.2	30	$b_1 - 65$
		125 (KR \geq 100)				$B_k + 7$					
UA1555 page 172											
-	50	117 (KR < 200)	$B_k + 5$	$B_k + 25$	2	$b_1 - 43$ (FA)	-	50	6.5	30	$b_1 - 85$
		200 (KR \geq 200)				$B_k + 5$					
Glide shoes	53	117 (KR < 200)	$B_k + 9$	$B_k + 29$	2	$b_1 - 47$ (FA)	-	50	6.5	30	$b_1 - 85$
		200 (KR \geq 200)				$B_k + 9$					
UA1665 page 182											
-	60	117 (KR < 200)	$B_k + 5$	$B_k + 25$	2	$b_1 - 47$ (FA)	-	60	8.5	30	$b_1 - 85$
		200 (KR \geq 200)				$B_k + 5$					
Glide shoes	63	117 (KR < 200)	$B_k + 10$	$B_k + 30$	2	$b_1 - 52$ (FA)	-	60	8.5	30	$b_1 - 85$
		200 (KR \geq 200)				$B_k + 10$					

The designations for dimension A refer to the version of the cable carrier connection.

* Dimension T for leg length support brackets (guiding channel open type for $B_k \geq 90$ mm).

** Dimension Y for guiding channel open for $B_k \geq 90$ mm).

 The cable carrier outer width without attachments B_k is taken into account for calculating the inner width of guide channel b_1 and the overall width B_{kA} .

Type	h ₁ [mm]	h _{KA} [mm]	b ₁ [mm]	B _{KA} [mm]	s [mm]	A [mm]	B [mm]	C [mm]	D [mm]	T* [mm]	Y** [mm]
UA1775 page 194											
–	77	150 (KR < 200) 300 (KR ≥ 200)	B _k + 5	B _k + 25	2	b ₁ – 19.6 (FU)	20	60	8.5	30	b ₁ – 60
Glide shoes	81.5	150 (KR < 200) 300 (KR ≥ 200)	B _k + 10	B _k + 30	2	b ₁ – 24.6 (FU)	20	60	8.5	30	b ₁ – 65
UA1995 page 202/340											
–	110	150 (KR < 200) 300 (KR ≥ 200)	B _k + 6	B _k + 26	2	b ₁ – 28 (FU)	35	60	8.5	30	b ₁ – 60
Glide shoes	116.5	150 (KR < 200) 300 (KR ≥ 200)	B _k + 11	B _k + 31	2	b ₁ – 28 (FU)	35	60	8.5	30	b ₁ – 60

The designations for dimension A refer to the version of the cable carrier connection.

Dimensions

TKK39 series

Type	h ₁ [mm]	h _{KA} [mm]	b ₁ [mm]	B _{KA} [mm]	s [mm]	A [mm]	B [mm]	C [mm]	D [mm]	T [mm]	Y [mm]
TKK39 page 222											
–	50	117	B _k + 5	B _k + 25	2	b ₁ – 43	24	40	5.2	30	b ₁ – 40

The designations for dimension A refer to the version of the cable carrier connection.

K series

When using aluminum hole stays, slide discs have to be placed on the side tabs between cable carrier and channel wall for spacing.

Type	h ₁ [mm]	h _{KA} [mm]	b ₁ [mm]	B _{KA} [mm]	s [mm]	A [mm]	B [mm]	C [mm]	D [mm]	T [mm]	Y [mm]
K0650 page 304											
–	57.5	117 (KR < 200) 200 (KR ≥ 200)	B _k + 5	B _k + 25	2	b ₁ – 19 (FU)	40	30	6.5	30	b ₁ – 65
Slide discs	57.5	117 (KR < 200) 200 (KR ≥ 200)	B _k + 13	B _k + 33	2	b ₁ – 27 (FA) b ₁ – 27 (FU)	40	30	6.5	30	b ₁ – 65
K0900 page 318											
–	78.5	150 (KR < 200) 300 (KR ≥ 200)	B _k + 5	B _k + 25	2	b ₁ – 20.5 (FU)	50	30	6.5	30	b ₁ – 65
Slide discs	78.5	150 (KR < 200) 300 (KR ≥ 200)	B _k + 19	B _k + 39	2	b ₁ – 34.0 (FA) b ₁ – 34.5 (FU)	50	30	6.5	30	b ₁ – 75

The designations for dimension A refer to the version of the cable carrier connection.



Dimensions

M series

Type	h_1 [mm]	h_{KA} [mm]	b_1 [mm]	B_{KA} [mm]	s [mm]	A [mm]	B [mm]	C [mm]	D [mm]	T [mm]	Y [mm]
M0475 page 364											
Glide shoes	41.5	70 (KR < 100) 125 (KR ≥ 100)	$B_k + 4$	$B_k + 24$	2	$b_1 - 39.0$ (FI)	24	30	6.5	30	$b_1 - 55$
M0650 page 372											
Glide shoes	60.6	117 (KR < 200) 200 (KR ≥ 200)	$B_k + 5$	$B_k + 25$	2	$b_1 - 55$ (FAI) $b_1 - 24$ (FU)	30 22.5	30	6.5	30	$b_1 - 70$
Offroad glide shoes	62.2	117 (KR < 200) 200 (KR ≥ 200)	$B_k + 5$	$B_k + 25$	2	$b_1 - 55$ (FAI) $b_1 - 24$ (FU)	30 22.5	30	6.5	30	$b_1 - 65$
M0950 page 388											
Glide shoes	83.5	150 (KR < 200) 300 (KR ≥ 200)	$B_k + 5$	$B_k + 25$	2	$b_1 - 70.0$ (FAI) $b_1 - 19.5$ (FU)	40 35	30	8.5	30	$b_1 - 100$ $b_1 - 60$
Offroad glide shoes	86	150 (KR < 200) 300 (KR ≥ 200)	$B_k + 5$	$B_k + 25$	2	$b_1 - 70.0$ (FAI) $b_1 - 19.5$ (FU)	40 35	30	8.5	30	$b_1 - 100$ $b_1 - 60$
M1250 page 414											
Glide shoes	99.5	200 (KR < 300) 400 (KR ≥ 300)	$B_k + 6$	$B_k + 26$	3	$b_1 - 83$ (FAI) $b_1 - 23$ (FU)	50 35	30	10.5 11	30	$b_1 - 125$ $b_1 - 65$
Offroad glide shoes	103	200 (KR < 300) 400 (KR ≥ 300)	$B_k + 6$	$B_k + 26$	3	$b_1 - 83$ (FAI) $b_1 - 23$ (FU)	50 35	30	10.5 11	30	$b_1 - 125$ $b_1 - 65$
M1300 page 440											
-	120	250 (KR < 320) 400 (KR ≥ 320)	$B_k + 6$	$B_k + 26$	3	$b_1 - 27$ (FU)	35	30	11	40	$b_1 - 75$
Glide shoes	127	250 (KR < 320) 400 (KR ≥ 320)	$B_k + 6$	$B_k + 26$	3	$b_1 - 27$ (FU)	35	30	11	40	$b_1 - 75$

The designations for dimension A refer to the version of the cable carrier connection.



Our engineers will be happy to help with your project planning – please contact us.



The cable carrier outer width without attachments B_k is taken into account for calculating the inner width of guide channel b_1 and the overall width B_{KA} .

Dimensions

XL | XLT series

Type	h ₁ [mm]	h _{KA} [mm]	b ₁ [mm]	B _{KA} [mm]	s [mm]	A [mm]	B [mm]	C [mm]	D [mm]	T [mm]	Y [mm]
XL1650 page 480											
–	140	300 (KR < 350) 400 (KR ≥ 350)	B _k + 6	B _k + 26	3	b ₁ – 99 (FAI)	50	40	13.5	40	b ₁ – 130
Glide shoes	147	300 (KR < 350) 400 (KR ≥ 350)	B _k + 6	B _k + 26	3	b ₁ – 99 (FAI)	50	40	13.5	40	b ₁ – 130

The designations for dimension A refer to the version of the cable carrier connection.

MT series

XLT series

ROBOTRAX® System

FLATVEYOR®

CLEANVEYOR®

LS/LSX series

S/SX series

S/SX-Tubes series

Accessories

TRAXLINE®



The cable carrier outer width without attachments B_k is taken into account for calculating the inner width of guide channel b₁ and the overall width B_{KA}.



Information on the fixing options for the standard channel can be found on page 828

Dimensions

QUANTUM® series

Type	h ₁ [mm]	h _{KA} [mm]	b ₁ [mm]	B _{KA} [mm]	s [mm]	A [mm]	B [mm]	C [mm]	D [mm]	T [mm]	Y [mm]
Q040 page 490											
–	40	70 (KR < 110) 125 (KR ≥ 110)	B _k + 4	B _k + 24	2	b ₁ – 18 (FU)	14	30	6.6	40	b ₁ – 35
Q60 page 496											
Glide shoes	66	117 (KR < 190) 200 (KR ≥ 190)	B _k + 9	B _k + 29	2	b ₁ – 29 (FU)	29	30	6.6	40	b ₁ – 45
Q080 page 506											
Glide shoes	88	150 (KR < 200) 300 (KR ≥ 200)	B _k + 13	B _k + 33	2	b ₁ – 38 (FU)	35	40	9	40	b ₁ – 70
Q100 page 520											
Glide shoes	108	250 (KR < 300) 400 (KR ≥ 300)	B _k + 13	B _k + 33	2	b ₁ – 43 (FU)	35	40	11	40	b ₁ – 105

The designations for dimension A refer to the version of the cable carrier connection.

TKA series

Type	h ₁ [mm]	h _{KA} [mm]	b ₁ [mm]	B _{KA} [mm]	s [mm]	A [mm]	B [mm]	C [mm]	D [mm]	T [mm]	Y [mm]
TKA30 page 574											
–	29.15	70 (KR < 95) 125 (KR ≥ 95)	B _k + 4	B _k + 24	2	b ₁ – 31 (FU)	–	50	6.5	–	–
TKA38 page 580											
–	36.75	70 (KR < 95) 125 (KR ≥ 95)	B _k + 4	B _k + 24	2	b ₁ – 10.5 (FU)	–	50	4.5	25	b ₁ – 55
TKA45 page 586											
–	51	117 (KR < 200) 200 (KR ≥ 200)	B _k + 5	B _k + 25	2	b ₁ – 12 (FU)	–	50	5.5	25	b ₁ – 60
TKA55 page 594											
–	65	117 (KR < 200) 200 (KR ≥ 200)	B _k + 5	B _k + 25	2	b ₁ – 16 (FU)	–	60	5.5	25	b ₁ – 75

The designations for dimension A refer to the version of the cable carrier connection.



The cable carrier outer width without attachments B_k is taken into account for calculating the inner width of guide channel b₁ and the overall width B_{KA}.

Dimensions

UAT series

Type	h ₁ [mm]	h _{KA} [mm]	b ₁ [mm]	B _{KA} [mm]	s [mm]	A [mm]	B [mm]	C [mm]	D [mm]	T [mm]	Y [mm]
UAT1555 page 606											
–	69	117 (KR ≤ 200) 200 (KR ≥ 200)	B _k + 5	B _k + 25	2	b ₁ – 15 (FU)	25 40	40	5.5	30	b ₁ – 80

The designations for dimension A refer to the version of the cable carrier connection.

S/SX series | S/SX tubes

Type	h ₁ [mm]	h _{KA} [mm]	b ₁ [mm]	B _{KA} [mm]	s [mm]	A [mm]	B [mm]	C [mm]	D [mm]	T [mm]	Y [mm]
S/SX 0650 page 726											
Glide shoes	56	125 (KR ≤ 155) 200 (KR > 155)	B _k + 10	B _k + 30	2	b ₁ – 47	45	15	6.4	30	b ₁ – 70
S/SX 0950 page 736											
Glide shoes	73	150 (KR ≤ 200) 300 (KR > 200)	B _k + 14	B _k + 34	2	b ₁ – 77	65	20	8.4	30	b ₁ – 100
S/SX 1250 page 748											
Glide shoes	99	200 (KR ≤ 300) 400 (KR > 300)	B _k + 12	B _k + 32	3	b ₁ – 76	80	25	10.5	30	b ₁ – 100
Offroad glide shoes	104	200 (KR ≤ 300) 400 (KR > 300)	B _k + 12	B _k + 32	3	b ₁ – 76	80	25	10.5	50	b ₁ – 100
S/SX 1800 page 772											
Glide shoes	155	300 (KR ≤ 435) 500 (KR > 435)	B _k + 17	B _k + 37	3	b ₁ – 94	115	30	13	50	b ₁ – 120

The designations for dimension A refer to the version of the cable carrier connection.



Standard fixing with angle brackets (standard)

The angle brackets are mounted at the joints, ensuring precise connection of the joint areas in addition to fixing the channel to the substructure.

- Optimum alignment of the joints
- Reduced installation times
- Minimum number of screw connections
- Reliable fixing, even under rough conditions

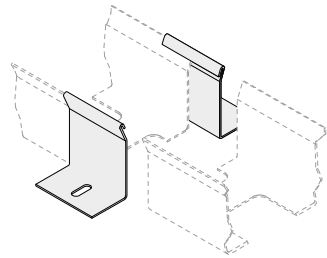
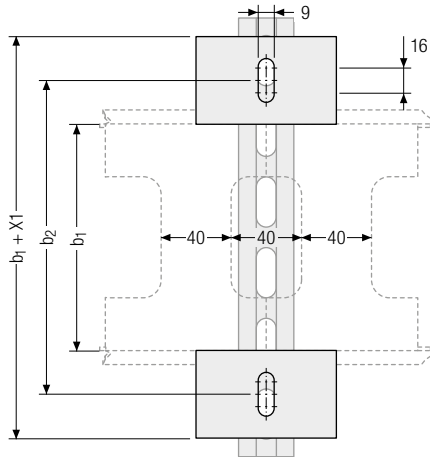
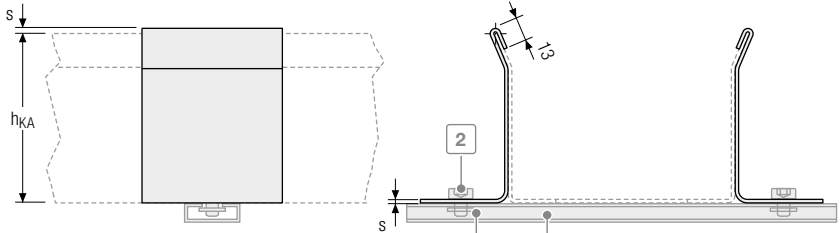

 The figure shows an open channel version

s [mm]	X1 [mm]	b2 [mm]
2	104	b ₁ + 54
3	106	b ₁ + 56

Calculating C-profile length

Suitable perforated C-profiles can be found from page 865

C-profile length L_p

$$L_p = b_1 + 106$$

C-profile length L_p rounded to 50 mm

 The sheet metal thickness "s" corresponds to the respective wall thickness "s" of the channel.

 As a standard, the angle brackets included with the delivery are installed on all joints as well as at both ends of a channel. If you require more angle brackets beyond this, please state this when ordering.

Fixing kit (optional)

The delivery scope of the standard channel does not include the optional joining clamp fixing kit.

Fixing kit

- 1 C-rail (length depends on b₁)
- 2 Hexagon socket screws
- 3 Slide nut

 The length of the C-rail depends on the channel width and is supplied in standard lengths. Please contact us if you require custom lengths.

Fixing with alignment flanges and floor fixing plate

The fixing tabs are mounted at the joints, ensuring precise connection of the joint areas in addition to fixing the channel to the substructure.

- Optimum alignment of the joints
- Minimum number of screw connections
- Reduced installation times
- Push-to-connect system

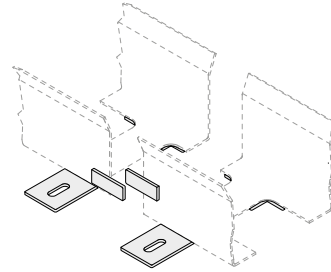

C-profile length L_P

C-profile length L_P
rounded to 50 mm

$$L_P = b_1 + 105$$

Fixing with floor fixing bracket

The floor fixing brackets are mounted at the joints, ensuring precise connection of the joint areas in addition to fixing the channel to the substructure.

- Easy alignment of the joints
- Minimized number of screw connections
- Reduced installation times

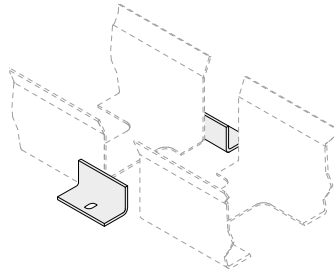

C-profile length L_P

C-profile length L_P
rounded to 50 mm

$$L_P = b_1 + 66$$

Fixing with lateral connecting flange

The unsupported connecting flanges are mounted at the joints, ensuring precise connection of the joint areas in addition to fixing the channel to the substructure.

- Unsupported joints without support (self supporting)
- Reliable, secure connection even with extreme vibrations or in unsupported channel arrangements

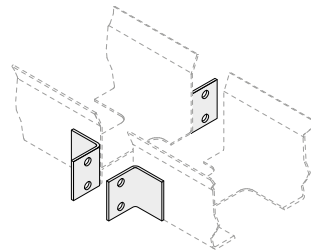

Order

Standard channel

To order the standard channel, please provide the following information:

- Number of guide channels
- Total length of channel
- Slide support height h_1
- Material
- Slide support length L_{KA}'
- Outer height of guide channel h_{KA}
- Version of guide channel
- Floor fixing
- inner width of guide channel b_1
- Part length
- Join connection

MT series

XLT series

ROBOTRAX® System

FLATVEYOR®

CLEANVEYOR®

LS/LSX series

S/SX series

S/SX-Tubes series

Accessories

TRAXLINE®

Guide channels in the modular system

- Modular system with optimized design for long travel lengths.
- Easy installation.
- Available in zinc plated sheet steel or stainless steel.

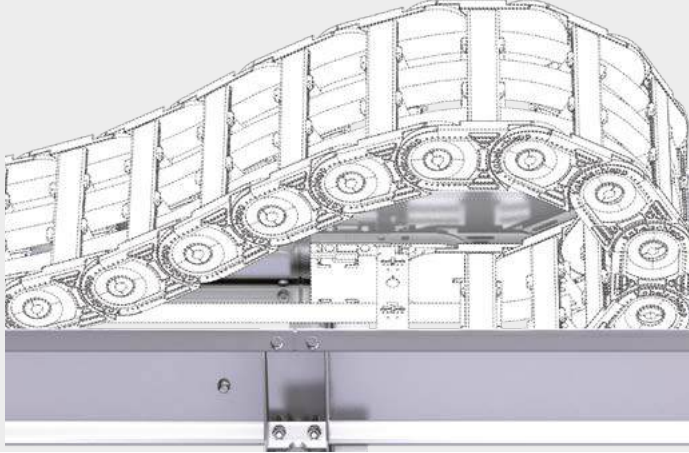

Zinc plated sheet steel /
stainless steel



Standard lengths 1000 / 2000 mm
Special lengths on request

Features

- Especially suitable for cranes and applications with long travel lengths
- Simple design for short installation times
- No accumulation of dirt through open construction
- Fast and easy installation thanks to pre-assembled sidebands and channel brackets
- Complete system for screw-fitting
- All components without welds

MT
seriesXLT
seriesROBOTRAX®
System

FLATVEYOR®

CLEANVEYOR®

LS/LSX
seriesS/SX
seriesS/SX-Tubes
series

Accessories

TRAXLINE®

One-sided arrangement

For one-sided arrangement of the cable carrier, the cable carrier slides behind the fixed point on a continuous slide support with run-off bevels.

Open design

Channel profile with and without slide supports incl. run-on bevels.

Dirt and liquids can drop through without restrictions.



Opposite arrangement

For opposite arrangement, a slide support is also attached for bridging between the fixed point connections.

Open design

Channel profile with and without slide supports incl. run-on bevels.

Dirt and liquids can drop through without restrictions.

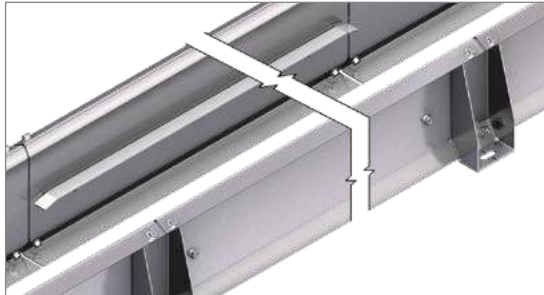

MT series
XLT series
ROBOTRAX® System
FLATVEYOR®
CLEANVEYOR®
LS/LSX series
S/SX series
S/SX-Tubes series
Accessories
TRAXLINE®

Dimensions

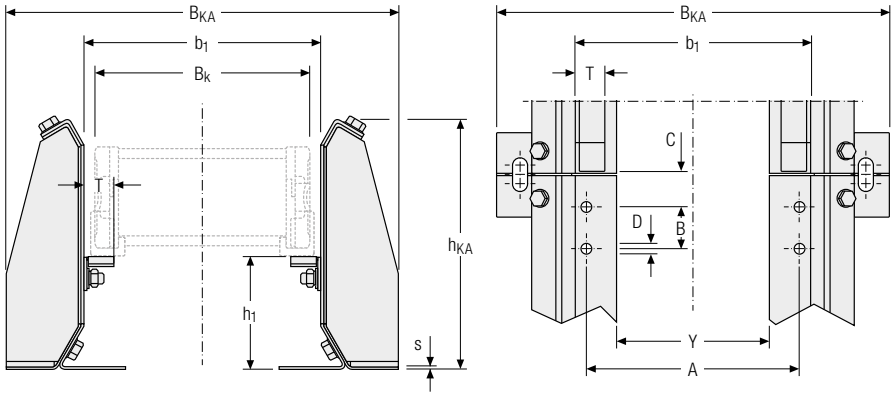

Dimensions

UNIFLEX Advanced

Type	h_1 [mm]	h_{KA} [mm]	b_1 [mm]	B_{KA} [mm]	s [mm]	A [mm]	B [mm]	C [mm]	D [mm]	T [mm]	Y [mm]
UA1555 page 172											
Glide shoes	53	124	$B_k + 9$	$B_k + 139$	2	$b_1 - 47$ (FA) $b_1 - 21$ (FU)	— 22.5	25 22.5	6.4 5.5	24	$b_1 - 69$
UA1665 page 182											
Glide shoes	63.5	124 (KR < 200) 176 (KR ≥ 200)	$B_k + 10$	$B_k + 140$	2	$b_1 - 52$ (FA) $b_1 - 19$ (FU)	— 22.5	30.5 25	8.4 5.5	24 25	$b_1 - 69$ $b_1 - 66$
UA1775 page 194											
Glide shoes	83.5	176 (KR < 200) 209 (KR ≥ 200)	$B_k + 10$	$B_k + 140$	2	$b_1 - 52$ (FA) $b_1 - 19$ (FU)	20	30	8.5	25	$b_1 - 66$ $b_1 - 70$
UA1995 page 202/340											
Glide shoes	116.5	258	$B_k + 11$	$B_k + 141$	2	$b_1 - 28$ (FU)	35	30	8.5	50	$b_1 - 100$

M series

Type	h_1 [mm]	h_{KA} [mm]	b_1 [mm]	B_{KA} [mm]	s [mm]	A [mm]	B [mm]	C [mm]	D [mm]	T [mm]	Y [mm]
M0650 page 372											
Glide shoes	60.5	124 (KR < 200) 176 (KR ≥ 200)	$B_k + 5$	$B_k + 135$	2	$b_1 - 55$ (FA)	30	25	6.4	24	$b_1 - 69$
Offroad glide shoes	63.5	124 (KR < 200) 176 (KR ≥ 200)	$B_k + 5$	$B_k + 135$	2	$b_1 - 24$ (FU)	22.5	30.5	6.5	25	$b_1 - 66$



The cable carrier outer width without attachments B_k is taken into account for calculating the inner width of guide channel b_1 and the overall width B_{KA} .



The dimension A refers only to the connection holes.

Dimensions

M series

Type	h ₁ [mm]	h _{KA} [mm]	b ₁ [mm]	B _{KA} [mm]	s [mm]	A [mm]	B [mm]	C [mm]	D [mm]	T [mm]	Y [mm]
M0950 page 388											
Glide shoes	83.5	176 (KR < 200) 209 (KR ≥ 200)	B _k + 5	B _k + 135	2	b ₁ – 70 (FAI)	40	30	8.4	25	b ₁ – 66
Offroad glide shoes	86.5					b ₁ – 19.5 (FU)	35	34.5	8.5		b ₁ – 70
M1250 page 414											
Glide shoes	99.5	209 (KR < 300) 258 (KR ≥ 300)	B _k + 6	B _k + 136	2	b ₁ – 83 (FAI)	50	35	10.5	50	b ₁ – 70
Offroad glide shoes	103					b ₁ – 23 (FU)	35	40.5	11		b ₁ – 90
M1300 page 440											
Glide shoes	127.5	258	B _k + 6	B _k + 136	2	b ₁ – 27 (FU)	35	30	11	50	b ₁ – 90

S/SX series

Type	h ₁ [mm]	h _{KA} [mm]	b ₁ [mm]	B _{KA} [mm]	s [mm]	A [mm]	B [mm]	C [mm]	D [mm]	T [mm]	Y [mm]
S/SX0650 page 726											
Glide shoes	56	124	B _k + 10	B _k + 140	2	b ₁ – 47 (FAI)	45	25	6,4	24	b ₁ – 69
S/SX0950 page 736											
Glide shoes	73	176	B _k + 10	B _k + 140	2	b ₁ – 77 (FAI)	65	30	8,4	27	b ₁ – 66
S/SX1250 page 748											
Offroad glide shoes	103	209 (KR < 350) 258 (KR ≥ 350)	B _k + 12	B _k + 142	2	b ₁ – 76 (FAI)	80	35	10,5	50	b ₁ – 100
S/SX1252 page 748											
Offroad glide shoes	103	209 (KR < 350) 258 (KR ≥ 350)	B _k + 12	B _k + 142	2	b ₁ – 76 (FAI)	80	35	10,5	50	b ₁ – 100



The cable carrier outer width without attachments B_k is taken into account for calculating the inner width of guide channel b₁ and the overall width B_{KA}.

MT series

XLT series

ROBOTRAX® System

FLATVEVOR®

CLEANVEVOR®

LS/LSX series

S/SX series

S/SX-Tubes series

Accessories

TRAXLINE®



Fixing with channel brackets

The channel brackets are mounted at the joins, ensuring precise connection of the joins in addition to fixing the channel to the substructure.

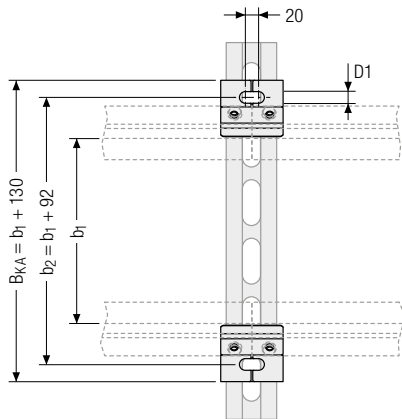
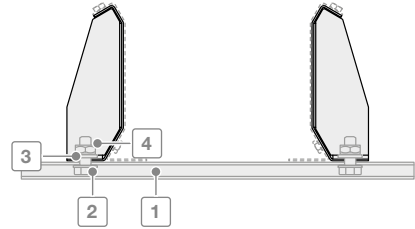
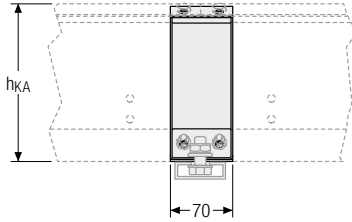
- Optimum alignment of the joins
- Reduced installation times
- No welds
- Minimum number of screw connections
- Reliable fixing under rough conditions
- High stability



h_{KA} [mm]	$D1$ [mm]	s [mm]
123	11	2
175	11	2
208	11	2
257	11	2

-  The sheet metal thickness "s" corresponds to the respective wall thickness "s" of the channel.
-  As a standard, the channel brackets included with the delivery are installed on all joins as well as at both ends of a channel. If you require more channel brackets beyond this, please state this when ordering.

Calculating C-profile length

Suitable perforated C-profiles can be found from page 865

C-profile length L_P

$$L_P = B_{KA} + 50 \text{ mm}$$

C-profile length L_P
rounded to 50 mm

Fixing material (optional)

The delivery scope of the Steel Guide System (TKSG) does not include the optional joining clamp fixing kit.

Fixing material

- 1 C-rail (length depends on b_1)
- 2 T-head bolt M10
- 3 Hex nut
- 4 Washer

Order

To order the Steel Guide System (TKSG), please provide the following information:

- Number of guide channels
- Outer height of guide channel h_{KA}
- Support height h_1
- Total length of channel
- Inner width of guide channel b_1
- Delivery (unmounted/mounted)
- Support length L_{KA}
- Material
- Fixing with or without C-profile

Cover for guide channels



Protection against external influences: Maintenance-friendly enclosure

- Easy inspection of the cable carrier.
- Openable at any position.
- Protection of the cable carrier system against external influences (coarse dirt, falling parts, snow, ice).
- Disassembly without screws.
- To open without tools.
- Secured against accidental closing in opening position.
- Can be used with any TSUBAKI KABELSCHLEPP channel system.
- Modular design.

MT
seriesXLT
seriesROBOTRAX®
System

FLATVEYOR®

CLEANVEYOR®

LS/LSX
seriesS/SX
seriesS/SX-Tubes
series

Accessories

TRAXLINE®



Our engineers will be happy to help with your project planning – please contact us.

Aluminium guide channels in the modular system

- Modular system with many mounting options.
- Standard lengths and sets.
- Lightweight design for high speeds.
- Slide and roller support made of high-quality plastic.

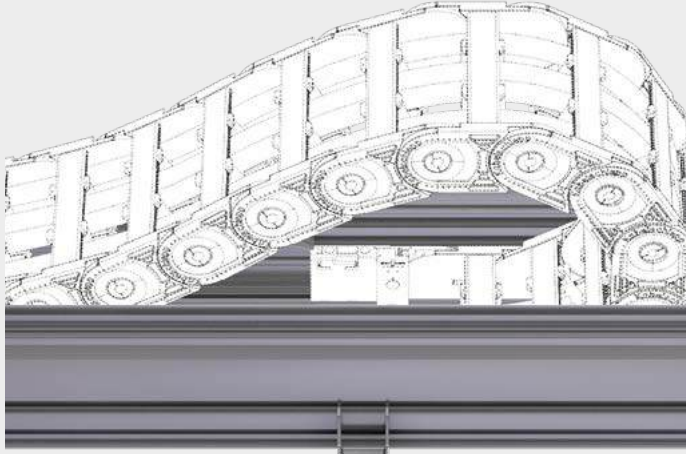

Channel side wall
Al alloy



Standard lengths 1000 / 2000 mm
Special lengths on request

Features

- Safe operation on long travel length
- Seawater resistant
- Twin channel connectors for parallel arrangement of several channels
- Standard- and Heavy-Duty-Version
- Variable fixation in standard stainless steel
- UMB mounting kit for assembly of the cable carrier

The Alu Guide System (TKAL) for long travel applications and high loads ensures secure guidance and smooth running of the energy chain in a gliding and rolling application.

The standardized channel profiles of 1000 / 2000 mm in length can be individually adjusted to the width of the chain. They can be quickly and easily be installed with the help of a mounting kit. Such UMB mounting kits are also available for attaching the fixed-point of the energy chain.

The optional damping band additionally reduces noise emission and guarantees an even quieter running of the chain.

TSUBAKI KABELSCHLEPP also offer the Alu Guide System (TKAL) together with the appropriate energy chain as well as with the ready-to-install TOTALTRAX® System including cables.



Assembly instruction

One-sided arrangement

For One-sided arrangement of the cable carrier, the cable carrier slides behind the fixed point on a slide support with run-on bevels.

Open design

Channel with and without supports incl. run-on bevels.

Dirt and water can drop through without restrictions.



Opposite arrangement

For opposite arrangement, a slide support with a minimum length of 500 mm is also attached for bridging between the fixed point connections.

Open design

Channel with and without supports incl. run-on bevels.

Dirt and water can drop through without restrictions.



Glide and roll support made of plastic

Glide support

- Simple and quick mounting by hooking in
- Slip-free hold in channel fastening groove
- 500 mm long, loadable up to 100 kg
- Compensation of linear expansion by tothing at the joints – continuous glide surface
- Optimized, rounded approach slope without bend



Roll support (TKAL 254/274)

- Simple and quick mounting by hooking in
- Slip-free hold in channel fastening groove
- 500 mm long, loadable up to 100 kg
- Compensation of linear expansion by tothing at the joints – continuous roll surface
- Minimal noise emission



MT series

XLT series

ROBOTRAX® System

FLATVEVOR®

CLEANVEVOR®

LS/LSX series

S/SX series

S/SX-Tubes series

Accessories

TRAXLINE®

Dimensions

TKAL 134

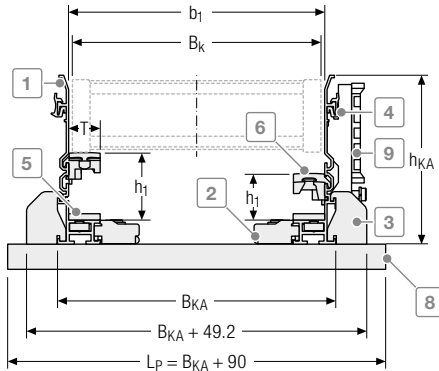

- 1 Channel profile
- 2 Internal mounting kit
- 3 External mounting kit
- 4 Joint connectors
- 5 Damping band (optional)
- 6 Stable gliding support made of plastic
- 7 Stable roller support made of plastic
- 8 C-Rail
- 9 Strain relief holder kit

 Using holder inside double-sided
 b_1 min.: 118 mm.
 Using holder outside double-sided
 b_1 min.: 50 mm.

TKAL 195

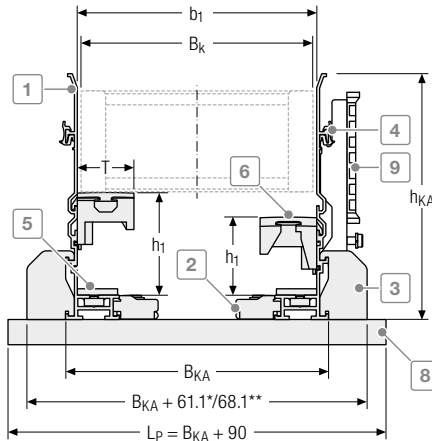

- 1 Channel profile
- 2 Internal mounting kit
- 3 External mounting kit
- 4 Joint connectors
- 5 Damping band (optional)
- 6 Stable gliding support made of plastic
- 7 Stable roller support made of plastic
- 8 C-Rail
- 9 Strain relief holder kit

 Using holder inside double-sided
 b_1 min.: 134 mm.
 Using holder outside double-sided
 b_1 min.: 90 mm.

* for C-profiles 3938/3939 ** for C-profiles 3940/3941

 As a standard, the mounting kits included with the delivery are installed on all joins as well as at both ends of a channel. If you require more angle brackets beyond this, please state this when ordering.

Dimensions

TKAL 254

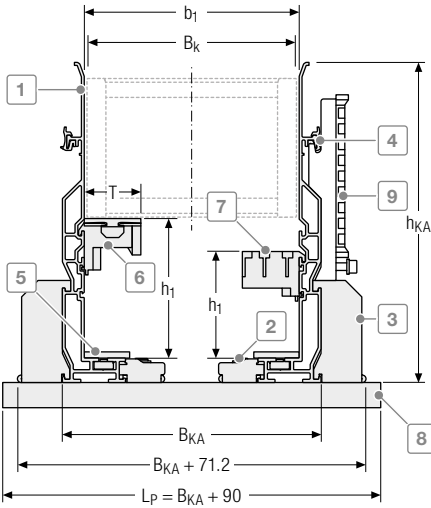

- 1 Channel profile
- 2 Internal mounting kit
- 3 External mounting kit
- 4 Joint connectors
- 5 Damping band (optional)
- 6 Stable gliding support made of plastic
- 7 Stable roller support made of plastic
- 8 C-Rail
- 9 Strain relief holder kit

 Using holder inside double-sided
 b_1 min.: 134 mm.
 Using holder outside double-sided
 b_1 min.: 90 mm.

TKAL 274

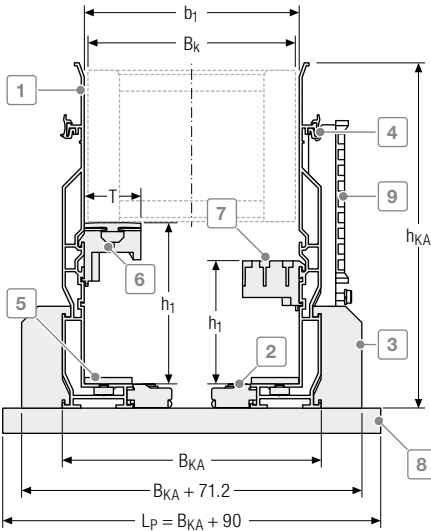

- 1 Channel profile
- 2 Internal mounting kit
- 3 External mounting kit
- 4 Joint connectors
- 5 Damping band (optional)
- 6 Stable gliding support made of plastic
- 7 Stable roller support made of plastic
- 8 C-Rail
- 9 Strain relief holder kit

 Using holder inside double-sided
 b_1 min.: 146 mm.
 Using holder outside double-sided
 b_1 min.: 90 mm.

Subject to change without notice.

 As a standard, the mounting kits included with the delivery are installed on all joins as well as at both ends of a channel. If you require more angle brackets beyond this, please state this when ordering.

MT series
XLT series
ROBOTRAX® System
FLATVEYOR®
CLEANVEYOR®
LS/LSX series
S/SX series
S/SX-Tubes series
Accessories
TRAXLINE®

UNIFLEX *Advanced series*

Type	Channel type	h ₁ [mm]	h _{KA} [mm]	b ₁ [mm]	b ₂ [mm]	b ₃ [mm]	B _{KA} [mm]	T [mm]
UA1455 page 162								
Glide shoes	134	40	134	B _k + 7	B _k + 50	B _k - 69	B _k + 25	25
UA1555 page 172								
Glide shoes	134	53	134	B _k + 9	B _k + 52	B _k - 67	B _k + 27	25
UA1665 page 182								
Glide shoes	195	61,5	195	B _k + 10	B _k + 60,15	B _k - 82,4	B _k + 28,6	45
UA1775 page 194								
Glide shoes	195	81	195	B _k + 9	B _k + 59,15	B _k - 83,4	B _k + 27,6	45
UA1995 page 202								
Glide shoes	254	116	254	B _k + 10,4	B _k + 71,9	B _k - 81	B _k + 45	45

K series

Type	Channel type	h ₁ [mm]	h _{KA} [mm]	b ₁ [mm]	b ₂ [mm]	b ₃ [mm]	B _{KA} [mm]	T [mm]
K0650 page 304								
-	134	56,5	134	B _k + 5	B _k + 48	B _k - 71	B _k + 23	25
Slide discs	134	56,5	134	B _k + 13	B _k + 56	B _k - 63	B _k + 31	25
K0900 page 318								
-	195	81	195	B _k + 5	B _k + 55,15	B _k - 87,4	B _k + 23,6	25
Slide discs	195	81	195	B _k + 19	B _k + 69,15	B _k - 73,4	B _k + 37,6	45

M series

Type	Channel type	h ₁ [mm]	h _{KA} [mm]	b ₁ [mm]	b ₂ [mm]	b ₃ [mm]	B _{KA} [mm]	T [mm]
M0650 page 372								
Glide shoes	195	61,5	195	B _k + 5	B _k + 55,15	B _k - 87,4	B _k + 23,6	45
Offroad glide shoes	195	61,5	195	B _k + 5	B _k + 55,15	B _k - 87,4	B _k + 23,6	45
M0950 page 388								
Offroad glide shoes	195	86	195	B _k + 5	B _k + 55,15	B _k - 87,4	B _k + 23,6	45
M1250 page 414								
Offroad glide shoes	274	103	274	B _k + 6	B _k + 67,5	B _k - 97,4	B _k + 40,6	45
M1300 page 440								
Glide shoes	274	127,5	274	B _k + 6	B _k + 67,5	B _k - 97,4	B _k + 40,6	45



The cable carrier outer width without attachments B_k is taken into account for calculating the inner width of guide channel b₁ and the overall width B_{KA}.



Our engineers will be happy to help with your project planning – please contact us.

QUANTUM® series

Type	Channel type	h ₁ [mm]	h _{KA} [mm]	b ₁ [mm]	b ₂ [mm]	b ₃ [mm]	B _{KA} [mm]	T [mm]
Q040 page 490								
–	134	40	134	B _k + 4	B _k + 47	B _k – 72	B _k + 22	25
Q060 page 496								
Glide shoes	195	66.5	195	B _k + 9	B _k + 59.15	B _k – 83.4	B _k + 27.6	45
Q080 page 506								
Glide shoes	195	86	195	B _k + 13	B _k + 63.15	B _k – 79.4	B _k + 31.6	45
Q100 page 520								
Glide shoes	274	108	274	B _k + 13	B _k + 74.5	B _k – 90.4	B _k + 47.6	45

TKA series

Type	Channel type	h ₁ [mm]	h _{KA} [mm]	b ₁ [mm]	b ₂ [mm]	b ₃ [mm]	B _{KA} [mm]	T [mm]
TKA38 page 580								
–	134	36.5	134	B _k + 4	B _k + 47	B _k – 72	B _k + 22	25
TKA45 page 586								
–	134	53	134	B _k + 5	B _k + 48	B _k – 71	B _k + 23	25
TKA55 page 594								
–	195	66.5	195	B _k + 5	B _k + 55.15	B _k – 87.4	B _k + 23.6	45

UAT series

Type	Channel type	h ₁ [mm]	h _{KA} [mm]	b ₁ [mm]	b ₂ [mm]	b ₃ [mm]	B _{KA} [mm]	T [mm]
UAT1555 page 606								
–	195	66.5	195	B _k + 5	B _k + 55.15	B _k – 87.4	B _k + 23.6	45



The cable carrier outer width without attachments B_k is taken into account for calculating the inner width of guide channel b₁ and the overall width B_{KA}.



Our engineers will be happy to help with your project planning – please contact us.

Standard and heavy duty

The internal or external mounting kits made of stainless steel are mounted at the joints, ensuring precise connection of the joints in addition to fastening the channel to the substructure.

Flying joint

The internal and external mounting kits made of stainless steel are mounted with a spacing of 30-500 mm from the joints, ensuring fastening of the channel to the substructure. The mounting kit does not necessarily have to be mounted at the joints.

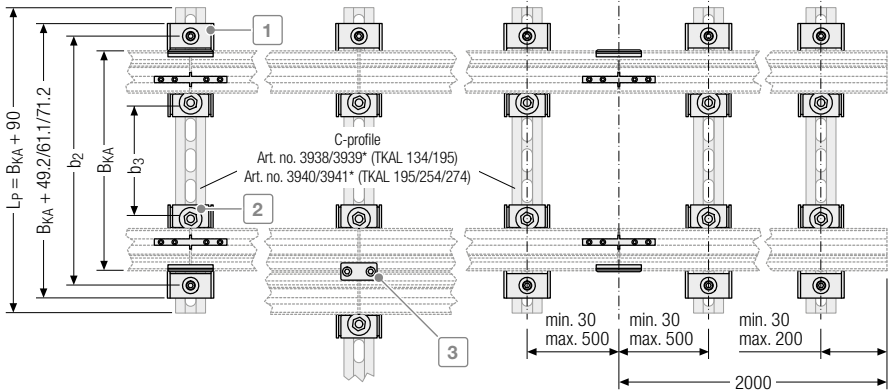

External mounting kit 1

The mounting brackets are mounted at the outside of the channel. The additional joint connectors ensure precise connection of the joints.

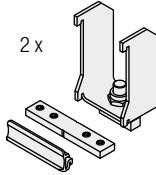

Internal mounting kit 2

The mounting brackets are mounted at the inside of the channel. The additional joint connectors ensure precise connection of the joints.

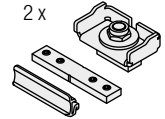

UMB mounting kit

The UMB mounting kit for fixed point ensures optimum fastening of the cable carrier in the channel and depends on the cable carrier type.

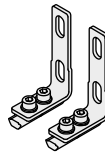

Holder set strain relief (optional)

The holders are mounted on the outside of the channel for fixed installation of cables.

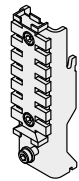

Twin channel connector 3 (optional)

The twin channel connectors enable the parallel arrangement of several channels.



 All pictures of the mounting kit are exemplary.

Order

To order the Alu Guide System, please provide the following information or the used cable carrier:

- Number of guide channels
- Total length of channel
- Support length L_{KA} '
- Type of fastening (internal/external)
- Delivery (unmounted/mounted)
- Support height h_1
- Fixing with C-profile
- Inner width of guide channel b_1

* More information can be found on page 865

MT series

XLT series

ROBOTRAX® System

FLATVEYOR®

CLEANVEYOR®

LS/LSX series

S/SX series

S/SX-Tubes series

Accessories

TRAXLINE®



Subject to change without notice.

MT series

XLT series

ROBOTRAX® System

FLATVEYOR®

CLEANVEYOR®

LS/LSX series

S/SX series

S/SX-Tubes series

Accessories

TRAXLINE®

Guide channels for multifunctional use

- Flexible use in many areas of application.
- Made of zinc plated sheet steel or stainless steel.
- Easy and fast horizontal or vertical arrangement.
- On its side laying installation possible.

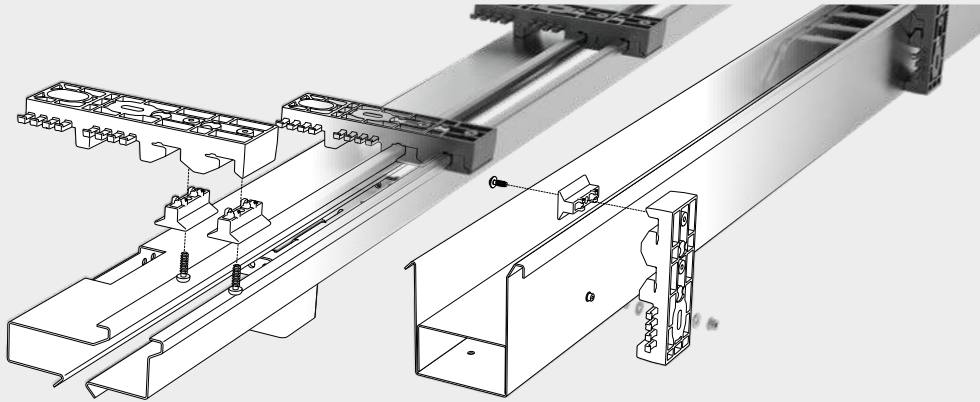

Zinc plated sheet steel or stainless steel



Standard lengths 2000 mm
Special lengths on request

Features

- Space-saving design
- Installation possible horizontal or laying on its side
- Easy and fast assembly by only one fitter
- Saves additional cable channels through installation of permanent cables directly on the holder (securely behind the channel)
- System remains horizontally adjustable after installation
- Mounting holes for the cable carriers and cable ducts every 850 mm
- Brackets are installed with screws or weld studs
- No complex steel structure necessary
- Suitable for all I-beams and box beams
- The same mounting brackets for different trough sizes/chain types
- Can be installed "flying"
- Closed design
 - Guiding for suspended chains
 - Allows operation of the cable carrier laying on its side
 - Mechanical protection
 - Protection against lateral acceleration
 - Protection against the cable carrier "banging" during acceleration and deceleration

With magnets as mounting aids for easy positioning of the holder and placing of the fastenings such as drilled holes or welded studs.

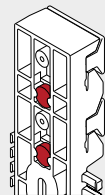

Our engineers will be happy to help with your project planning – please contact us.

One-sided arrangement with central feed

For single-sided arrangement of the cable carrier with central feed, the cable carrier slides behind the fixed point on a continuous slide plate.

Closed design – standing without enclosure (Variant A)

One-part channel in version with open top and one-part slide plate.

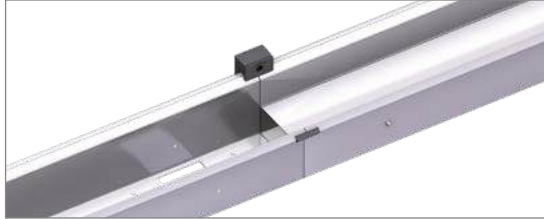

Closed design – standing with enclosure (Variant B)

One-part channel in version with closed top (enclosure) and one-part slide plate.

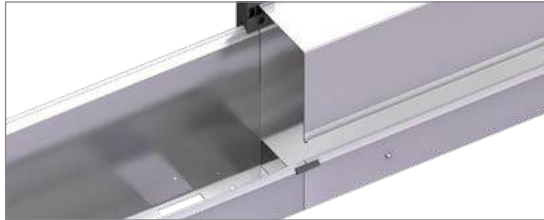

 For central feed, permanent cables can be placed directly on the holder (securely behind the channel)

One-sided arrangement with end feed

For single-sided arrangement of the cable carrier with end feed, the cable carrier slides behind the fixed point on itself.

Closed design – standing without enclosure (Variant A)

One-part channel in version with open top and one-part slide plate.



Closed design – standing with enclosure (Variant B)

One-part channel in version with closed top (enclosure) and one-part slide plate.



MT series
XLT series
ROBOTRAX® System
FLATVEYOR®
CLEANVEYOR®
LS/LSX series
S/SX series
S/SX-Tubes series
Accessories
TRAXLINE®

Opposite arrangement

For opposite arrangement, a slide support is also attached for bridging between the fixed point connections.

Closed design – standing without enclosure (Variant A)

One-part channel in version with open top and one-part slide plate.

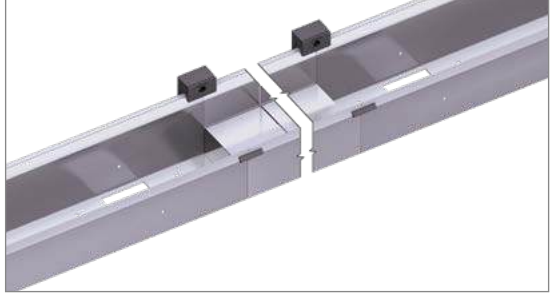

Closed design – standing with enclosure (Variant B)

One-part channel in version with closed top (enclosure) and one-part slide plate.

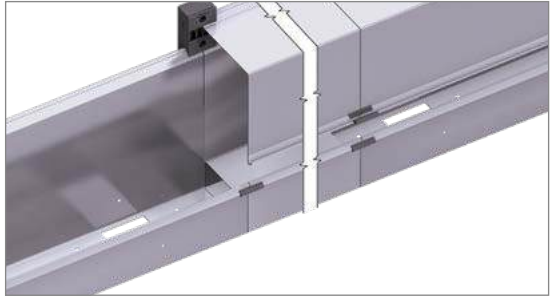

Closed design – laying on its side with enclosure (Variant C)

One-part channel laying on its side in enclosed version (enclosure) incl. driver sledge.



MT series

XLT series

ROBOTRAX® System

FLATVEYOR®

CLEANVEYOR®

LS/LSX series

S/SX series

S/SX-Tubes series

Accessories

TRAXLINE®



MT
series

XLT
series

ROBOTRAX®
System

FLATVEYOR®

CLEANVEYOR®

LS/LSX
series

S/SX
series

S/SX-Tubes
series

Accessories

TRAXLINE®

Dimensions | standing without enclosure (Variant A)

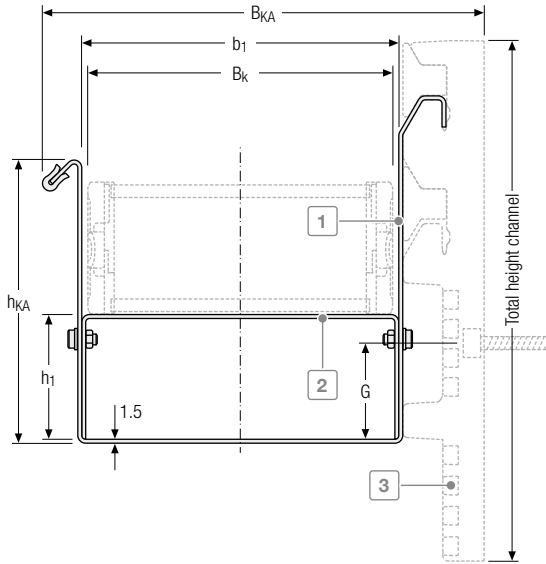

- 1 Guide channel
- 2 Stable gliding support made of zinc plated sheet steel or stainless steel
- 3 Holder

Slide support height

$$h_1 = h_G$$

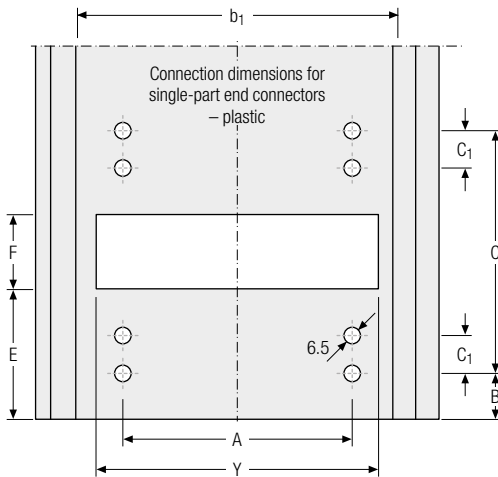

QuickTrax® series

B _i [mm]	KR [mm]	h ₁ [mm]	h _{KA} [mm]	Total height channel [mm]	b ₁ [mm]	B _{KA} [mm]	A [mm]	B [mm]	C [mm]	C ₁ [mm]	E [mm]	F [mm]	G [mm]	Y [mm]
QT0320 with channel holder 202 page 138														
25	75	25.5	54	202	42	90.7	10	79	140	14	129	40	39	27
50	100				67									115.7
QT0320 with channel holder 155 page 138														
25	75	25.5	54	156.5	42	90.7	10	79	140	14	129	40	39	27
50	100				67									115.7

EasyTrax® series

B _i [mm]	KR [mm]	h ₁ [mm]	h _{KA} [mm]	Total height channel [mm]	b ₁ [mm]	B _{KA} [mm]	A [mm]	B [mm]	C [mm]	C ₁ [mm]	E [mm]	F [mm]	G [mm]	Y [mm]
ET0320 with channel holder 202 page 250														
25	75	25.5	54	202	42	90.7	10	79	140	14	129	40	39	27
50	100				67									115.7
ET0320 with channel holder 155 page 250														
25	75	25.5	54	156.5	42	90.7	10	79	140	14	129	40	39	27
50	100				67									115.7

 MT
series

 XLT
series

 ROBOTRAX®
System

FLATVEYOR®

CLEANVEYOR®

 LS/LSX
series

 S/SX
series

 S/SX-Tubes
series

Accessories

TRAXLINE®



The cable carrier outer width without attachments B_k is taken into account for calculating the inner width of guide channel b₁ and the overall width B_{KA}.



Information on the fixing options for the Easy Guide Systems can be found on page 863

Dimensions | standing without enclosure (Variant A)

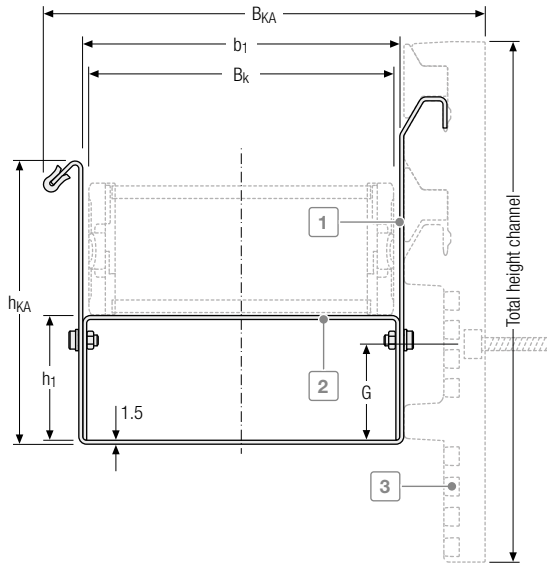

- 1 Guide channel
- 2 Stable gliding support made of zinc plated sheet steel or stainless steel
- 3 Holder

Slide support height

$$h_1 = h_G$$

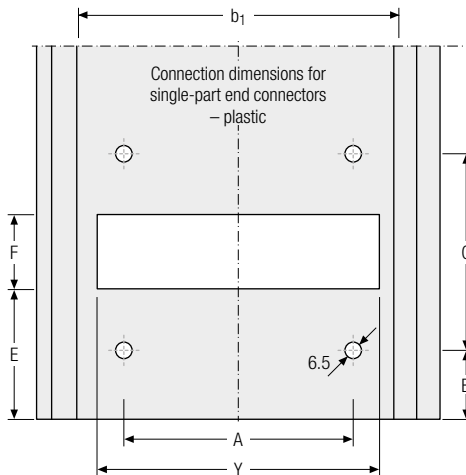



UNIFLEX *Advanced series*

B _i [mm]	KR [mm]	h ₁ [mm]	h _{KA} [mm]	Total height channel [mm]	b ₁ [mm]	B _{KA} [mm]	A [mm]	B [mm]	C [mm]	E [mm]	F [mm]	G [mm]	Y [mm]
UA1455 with channel holder 202 page 162													
58					79	127.7	43.5						64
78	125	36	100	202	99	147.7	63.5	73	152	123	52	39	84
103					124	172.7	88.5						109
UA1455 with channel holder 155 page 162													
58					79	127.7	43.5						64
78	125	36	100	156.5	99	147.7	63.5	73	152	123	52	39	84
103					124	172.7	88.5						109
UA1555 with channel holder 202 Seite 172													
50					73	121.7	30						58
75	125	50	115	202	98	146.7	55	61	176	111	76	39	83
100					123	171.7	80						108
UA1555 with channel holder 155 page 172													
50					73	121.7	30						58
75	125	50	115	156.5	98	146.7	55	61	176	111	76	39	83
100					123	171.7	80						108

 Standard version of the cable carrier in the Easy Guide System without glide shoes.

 The cable carrier outer width without attachments B_k is taken into account for calculating the inner width of guide channel b₁ and the overall width B_{KA}.

 Our engineers will be happy to help with your project planning – please contact us.

 Information on the fixing options for the Easy Guide Systems can be found on page 863

MT series

XLT series

ROBOTRAX® System

FLATVEYOR®

CLEANVEYOR®

LS/LSX series

S/SX series

S/SX-Tubes series

Accessories

TRAXLINE®

Dimensions | Ground holder (Variant A)

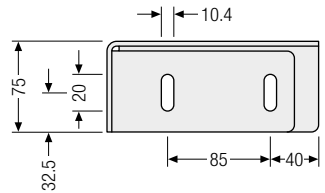
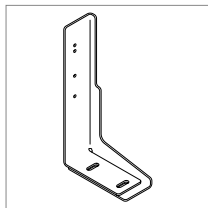
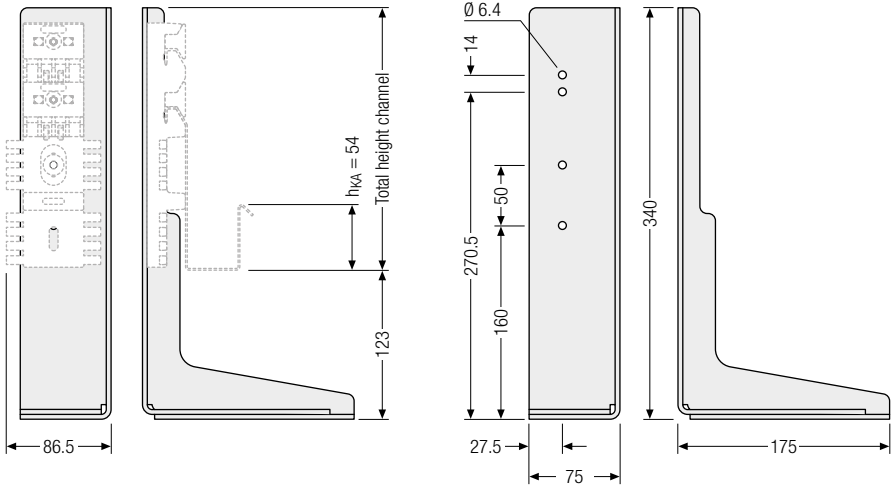
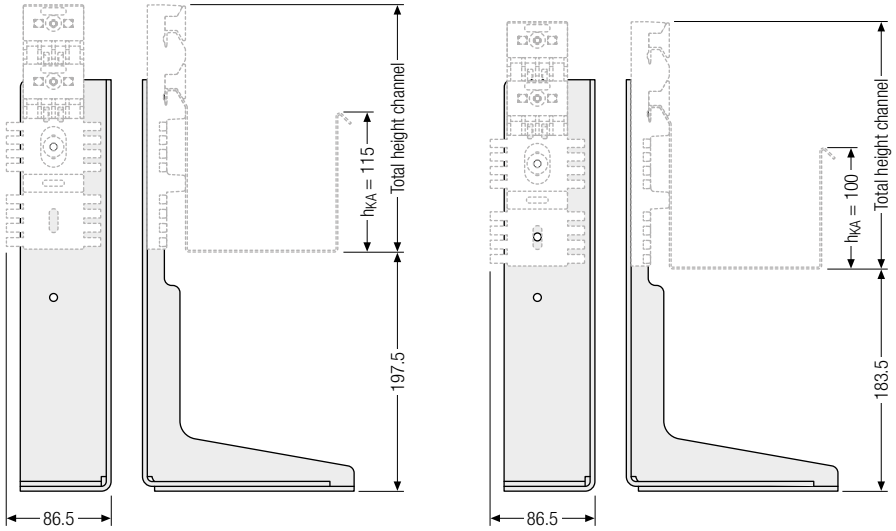

Dimensions | Ceiling holder (Variant A)

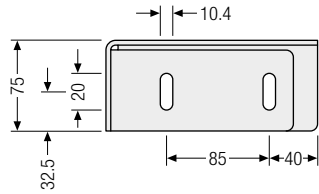
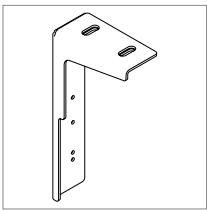
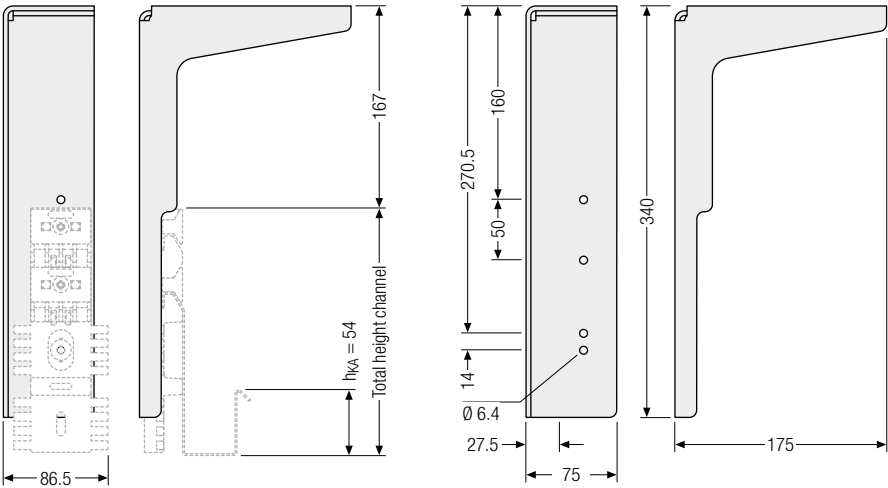
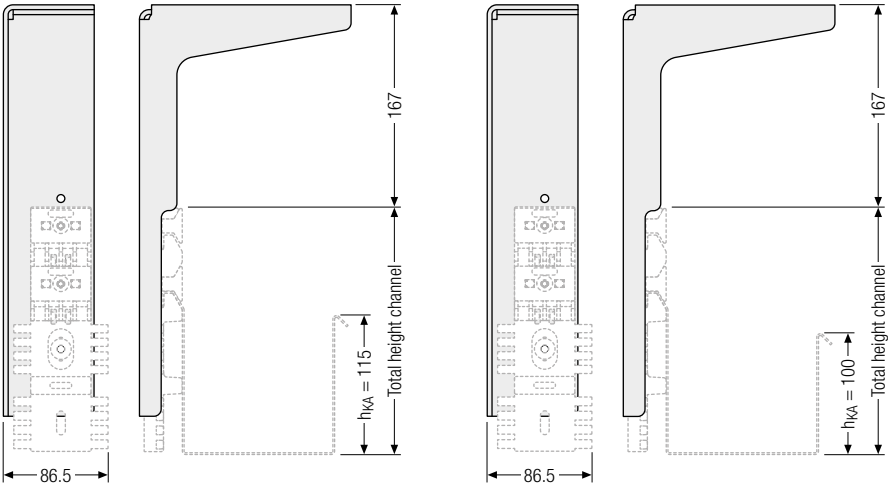

Subject to change without notice.

TRAXLINE®	Accessories	S/SX-Tubes series	S/SX series	LS/LSX series	CLEANVEYOR®	FLATVEYOR®	ROBOTRAX® System	XLT series	MT series
-----------	-------------	-------------------	-------------	---------------	-------------	------------	------------------	------------	-----------

Dimensions | standing with enclosure (Variant B)

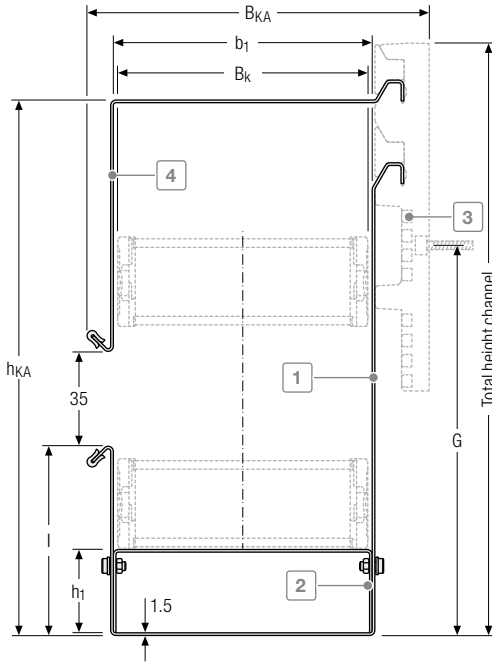

- 1 Guide channel
- 2 Stable gliding support made of zinc plated sheet steel or stainless steel
- 3 Holder
- 4 Enclosure

Slide support height

$$h_1 = h_G$$

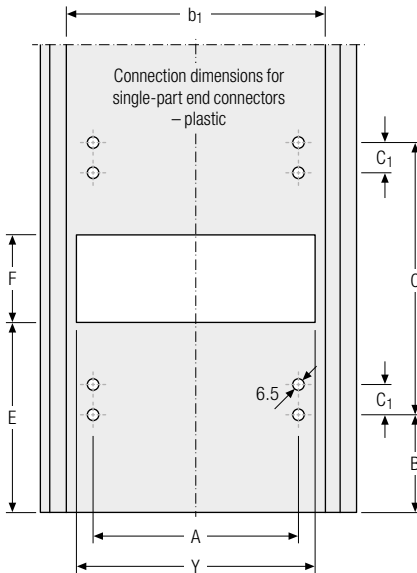

QuickTrax® series

B _i [mm]	KR [mm]	h ₁ [mm]	h _{KA} [mm]	Total height channel [mm]	b ₁ [mm]	B _{KA} [mm]	A [mm]	B [mm]	C [mm]	C ₁ [mm]	E [mm]	F [mm]	G [mm]	I [mm]	Y [mm]
QT0320 with channel holder 202 page 138															
25	100	25.5	236.5	269.5	42	90.7	10	79	140	14	129	40	152	54	27
50					67	115.7	35								52
QT0320 with channel holder 155 page 138															
25	100	25.5	236.5	269.5	42	90.7	10	79	140	14	129	40	152	54	27
50					67	115.7	35								52

EasyTrax® series

B _i [mm]	KR [mm]	h ₁ [mm]	h _{KA} [mm]	Total height channel [mm]	b ₁ [mm]	B _{KA} [mm]	A [mm]	B [mm]	C [mm]	C ₁ [mm]	E [mm]	F [mm]	G [mm]	I [mm]	Y [mm]
ET0320 with channel holder 202 page 250															
25	100	25.5	236.5	269.5	42	90.7	10	79	140	14	129	40	152	54	27
50					67	115.7	35								52
ET0320 with channel holder 155 page 250															
25	100	25.5	236.5	269.5	42	90.7	10	79	140	14	129	40	152	54	27
50					67	115.7	35								52

MT series

XLT series

ROBOTRAX® System

FLATVEYOR®

CLEANVEYOR®

LS/LSX series

S/SX series

S/SX-Tubes series

Accessories

TRAXLINE®

 The cable carrier outer width without attachments B_k is taken into account for calculating the inner width of guide channel b₁ and the overall width B_{KA}.

 Information on the fixing options for the Easy Guide Systems can be found on page 863

Dimensions | standing with enclosure (Variant B)

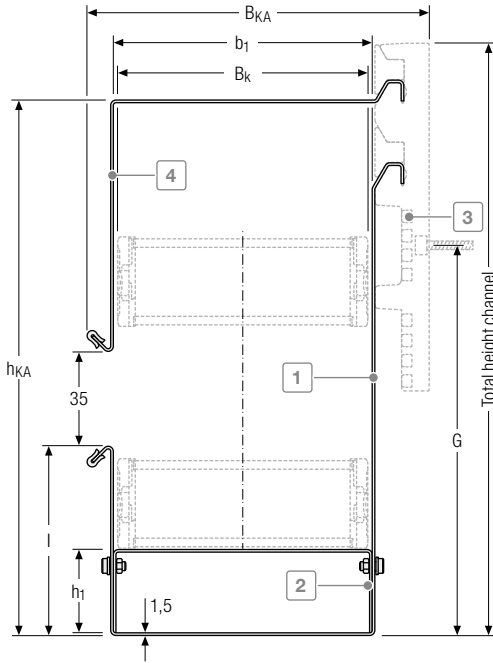

- 1 Guide channel
- 2 Stable gliding support made of zinc plated sheet steel or stainless steel
- 3 Holder
- 4 Enclosure

Slide support height

$$h_1 = h_G$$

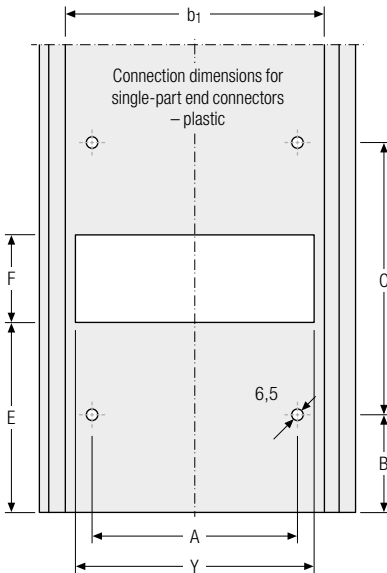

UNIFLEX Advanced series

B _i [mm]	KR [mm]	h ₁ [mm]	h _{KA} [mm]	Total height channel [mm]	b ₁ [mm]	B _{KA} [mm]	A [mm]	B [mm]	C [mm]	E [mm]	F [mm]	G [mm]	I [mm]	Y [mm]
UA1455 with channel holder 202 page 162														
58					79	127.7	43.5							64
78	125	36	297	330	99	147.7	63.5	73	152	123	52	212.5	100	84
103					124	172.7	88.5							109
UA1455 with channel holder 155 page 162														
58					79	127.7	43.5							64
78	125	36	297	330	99	147.7	63.5	73	152	123	52	212.5	100	84
103					124	172.7	88.5							109
UA1555 with channel holder 202 page 172														
50					73	121.7	30							58
75	125	50	311	344	98	146.7	55	61	176	121	76	226.5	111	83
100					123	171.7	80							108
UA1555 with channel holder 155 page 172														
50					73	121.7	30							58
75	125	50	311	344	98	146.7	55	61	176	121	76	226.5	111	83
100					123	171.7	80							108

 Standard version of the cable carrier in the Easy Guide System without glide shoes.

MT series

XLT series

ROBOTRAX® System

FLATVEYOR®

CLEANVEYOR®

LS/LSX series

S/SX series

S/SX-Tubes series

Accessories

TRAXLINE®

 The cable carrier outer width without attachments B_k is taken into account for calculating the inner width of guide channel b₁ and the overall width B_{KA}.

 Our engineers will be happy to help with your project planning – please contact us.

 Information on the fixing options for the Easy Guide Systems can be found on page 863

Dimensions | Ground holder (Variant B)

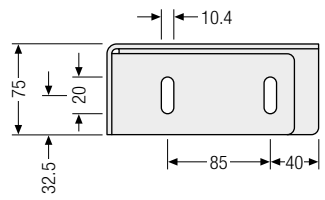
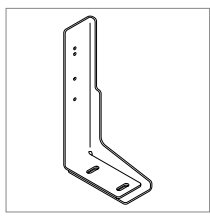
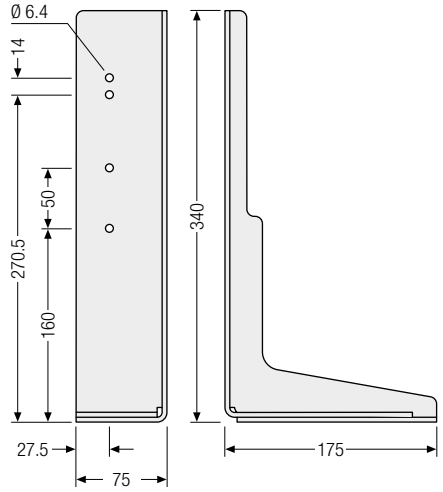
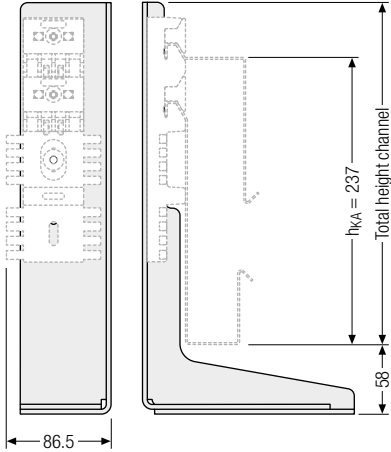
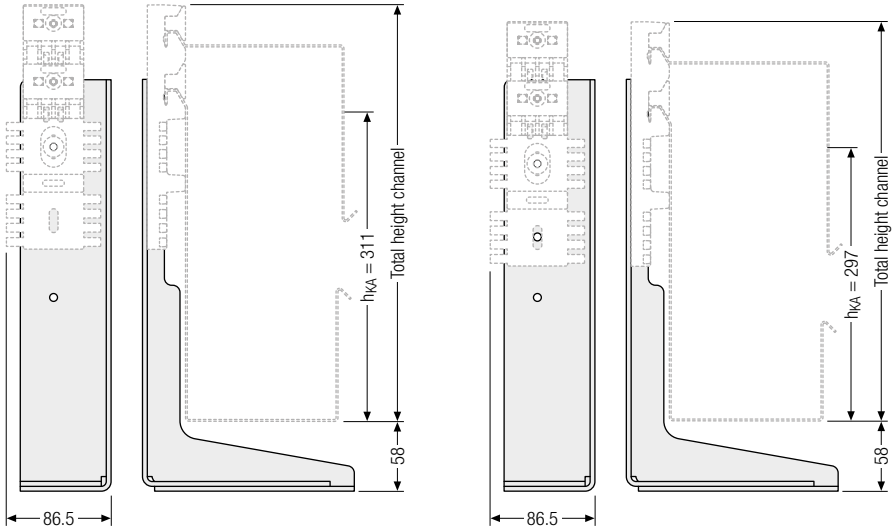

Dimensions | Ceiling holder (Variant B)

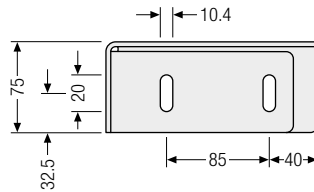
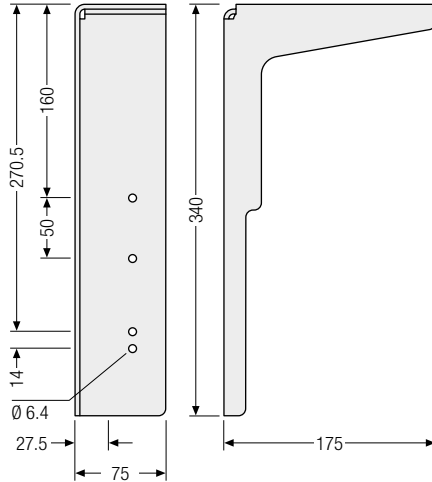
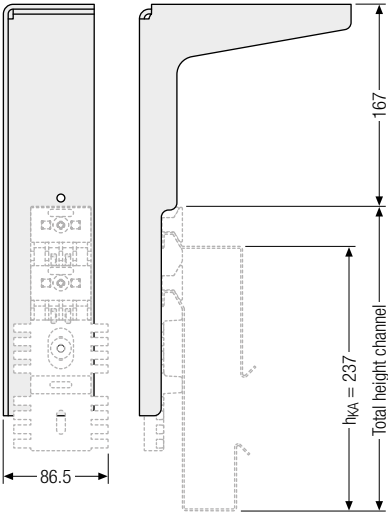
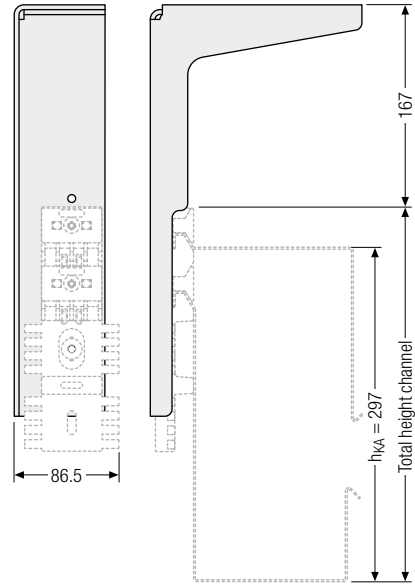
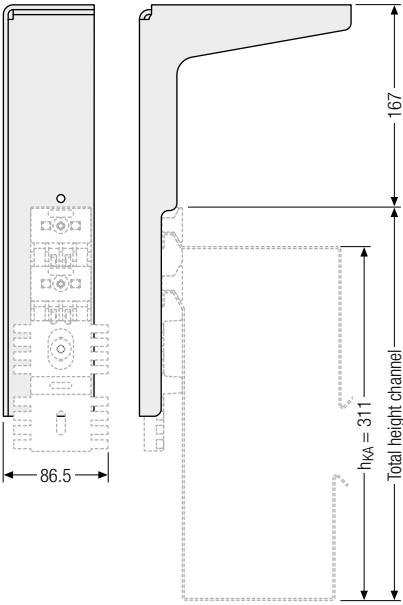

Subject to change without notice.

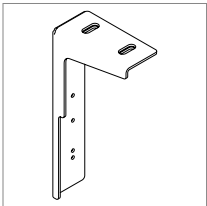

MT series

XLT series

ROBOTRAX® System

FLATVEYOR®

CLEANVEYOR®

LS/LSX series

S/SX series

S/SX-Tubes series

Accessories

TRAXLINE®

Dimensions | laying on its side (Variant C)

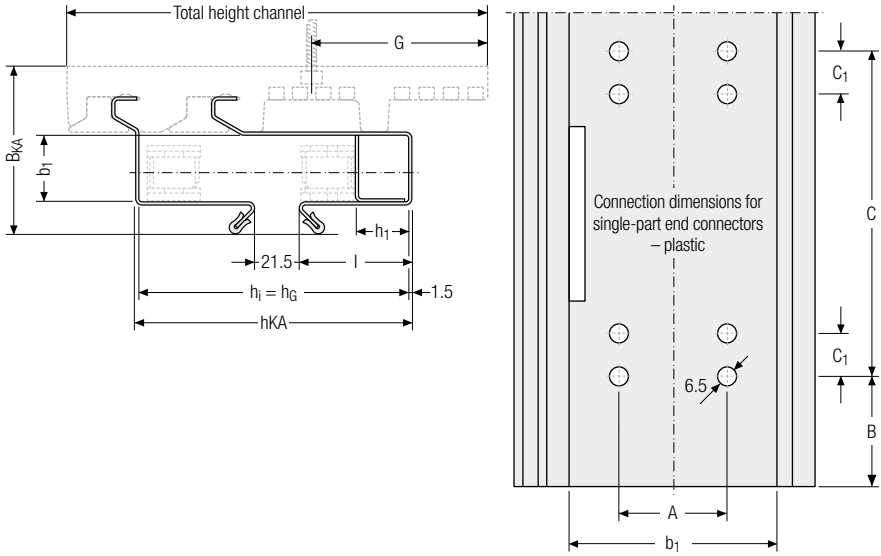

QuickTrax® series | UNIFLEX Advanced series

B_i [mm]	KR [mm]	h_{KA} [mm]	Total height channel [mm]	b_1 [mm]	B_{KA} [mm]	A [mm]	B [mm]	C [mm]	C_1 [mm]	G [mm]	I [mm]
QT0320 UA1320 with channel holder 202 page 138 + 156											
15				32	80.7	—					
25	48	132.5	202	42	90.7	10	85	128	14	37,5	54
50				67	115.7	35.5					
QT0320 UA1320 with channel holder 155 page 138 + 156											
15				32	80.7	—					
25	48	132.5	165.5	42	90.7	10	85	128	14	84,5	54
50				67	115.7	35.5					

Mounting options

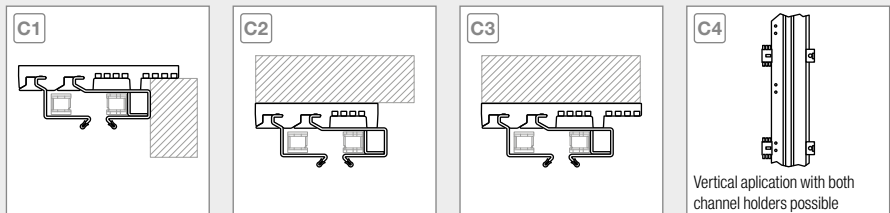

Vertical application with both
channel holders possible



Information on the fixing options for the Easy Guide Systems can be found on page 863

Dimensions | laying on its side (Variant C) | Driver sledge

 For the version of the Easy Guide System laying on its side, the correct carrier sledge has to be used for each cable carrier width.

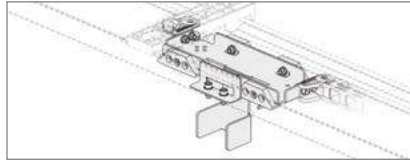

Driver sledge 79-112 for B_i 15

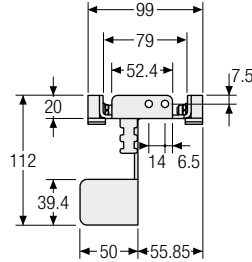
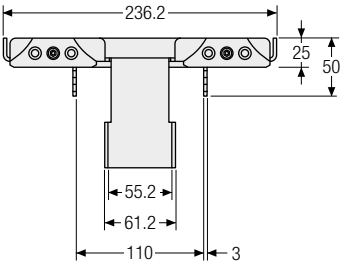

Driver sledge 156-360 for B_i 25

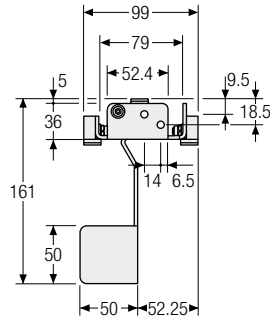
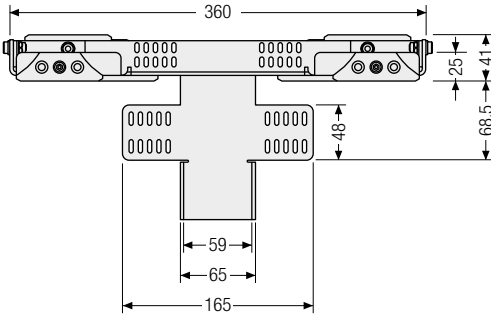

Driver sledge 175-360 for B_i 50

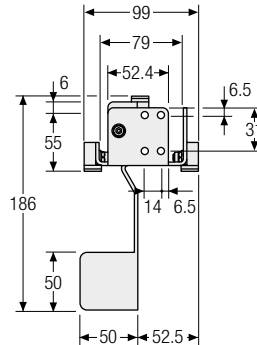
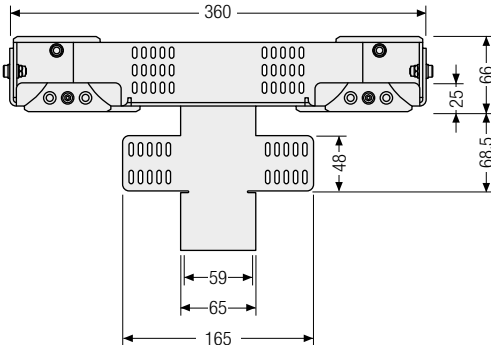

MT series
XLT series
ROBOTRAX® System
FLATVEVOR®
CLEANVEVOR®
LS/LSX series
S/SX series
S/SX-Tubes series
Accessories
TRAXLINE®

Dimensions | Ground holder (Variant C)

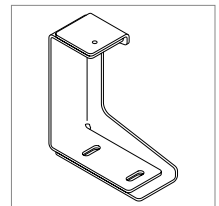
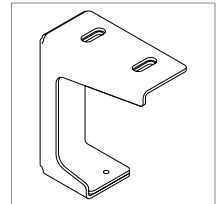
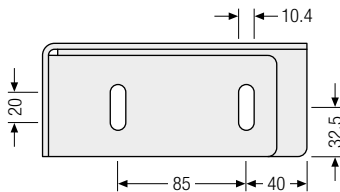
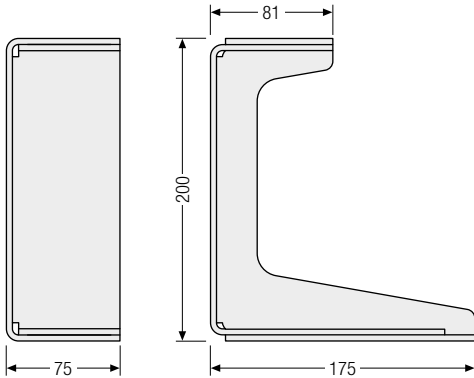
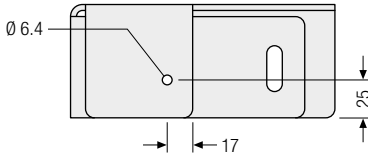
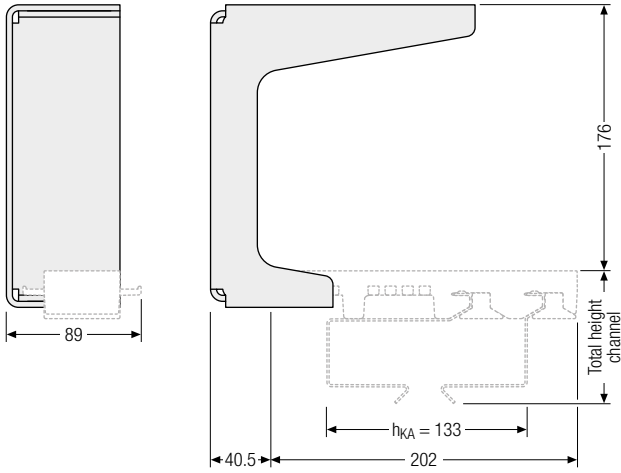

For variant C (laying on its side), the holders have to be mounted on the joins. For variant A and B, the holders can be installed in any position.

Mounting with holder 155

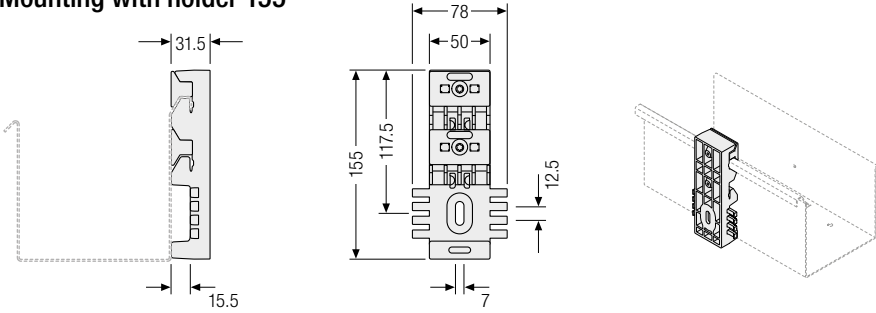

Mounting with holder 202

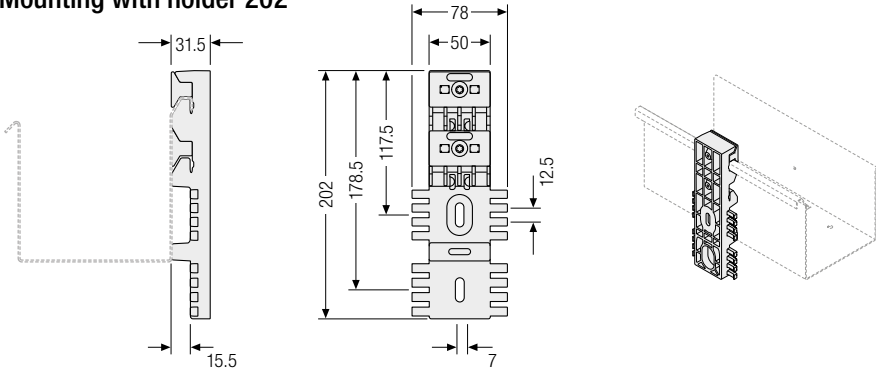

Mounting kit

Set for fixing the holders on the channel.

Installation kit

- | | |
|------------------|-----------------|
| 1 Holder | 5 Screw M4 x 12 |
| 2 Holder clamp | 6 Screw |
| 3 Join connector | 7 Washer |
| 4 Nut | 8 Washer |

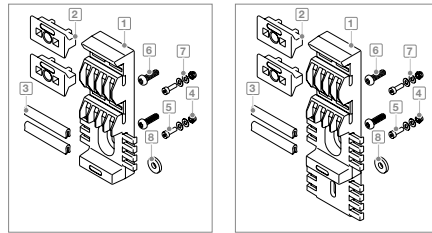

Order example

To order the Easy Guide System, please provide the following information and the used cable carrier:

- Variant of channel (A, B or C)
- Number of guide channels
- Total length of channel
- Support length L_{KA} ¹
- Variant of holder (H155/H202)
- Type of fastening (Wall/ceiling/floor)

MT series
XLT series
ROBOTRAX® System
FLATVEVOR®
CLEANVEVOR®
LS/LSX series
S/SX series
S/SX-Tubes series
Accessories
TRAXLINE®

Guide channels for vertical hanging applications

- Ready-to-install channel system made of aluminum.
- Standardized module.
- Easy installation.
- For elevators, storage and retrieval systems and many other applications.

Aluminum channel system for UNIFLEX *Advanced*

The ready-to-install channel system for vertical hanging applications from TSUBAKI KABELSCHLEPP is ideal for use in fast moving storage and retrieval systems with high lateral accelerations. Other typical fields of application are lifters, elevators, construction elevators, crane elevators or lifts. As a ready-to-connect complete system including driver, cables and strain reliefs, it is very easy to install. Standard parts result in short delivery times and a cost efficient solution. This allows energy and data to be transferred within one system reliably and without interruptions.

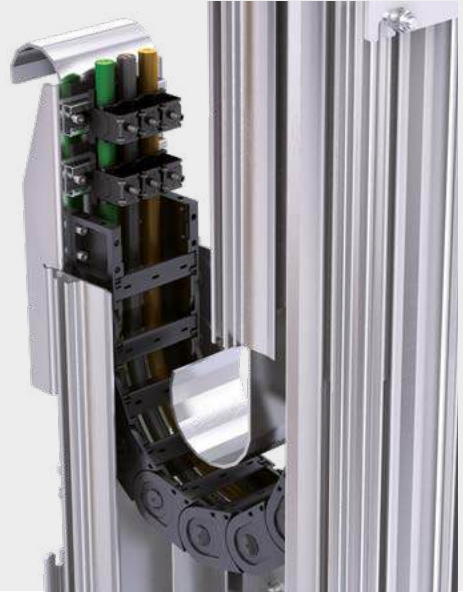

Features

- Standardized for UNIFLEX *Advanced* 1555
- Available from 75 mm inner width and 125 mm bending radius
- Other series and types on request
- Suitable for extremely long travel lengths
- Fixed point offset possible
- Fixed point connection alternatively left or right
- Cable outlet on the driver alternatively towards the front or rear
- Standard lengths of the aluminum profile. Custom lengths also possible on request
- Mounting distance of the channel brackets flexibly adaptable
- Optional C-rails for assembly
- Attachment parts in galvanized steel or stainless steel

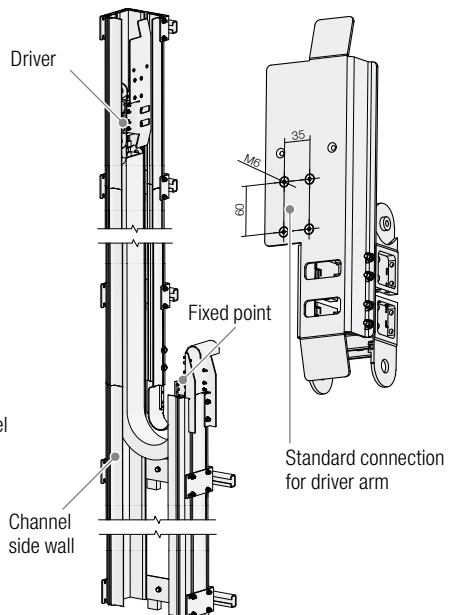

Our engineers will be happy to help with project planning – please contact us

- Assembly profiles with sloping sides can be used for all guide channels for fastening
- Lengths in 50 mm grid possible



C-profile, perforated, 34 x 15 mm

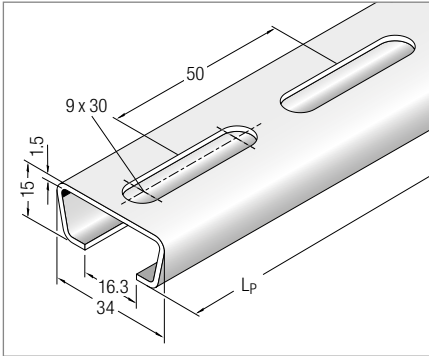

(slot width 16 – 17 mm)

Material

Steel
Stainless steel (ER 1S)

Article no.

3938
3939

Attach profile with cheese-head screws M8 – DIN 6912

C-profile, perforated, 40 x 22 mm

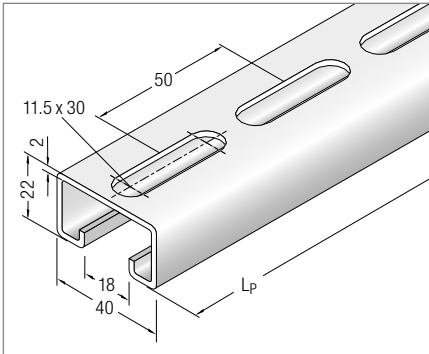

(slot width 18 mm)

Material

Steel
Stainless steel (ER 1S)

Article no.

3940
3941

Attach profile with cheese-head screws M8 – DIN 6912

MT series

XLT series

ROBOTRAX® System

FLATVEYOR®

CLEANVEYOR®

LS/LSX series

S/SX series

S/SX-Tubes series

Accessories

TRAXLINE®