

TKHP series

High-Performance cable carriers
for long travel lengths and
high additional loads

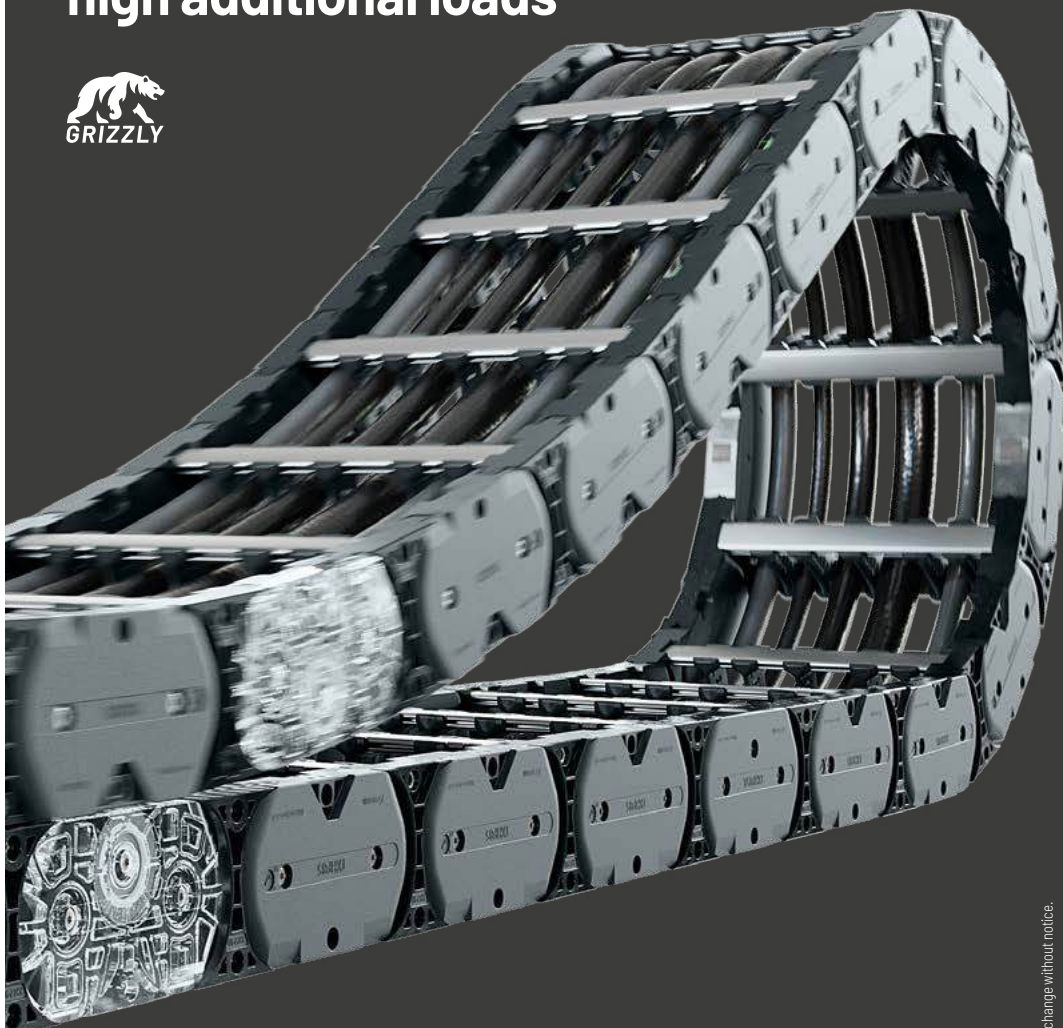

Trademarks are legally protected for the TSUBAKI KABELSCHLEPP GmbH
as a national or international registration in the following countries:
tsubaki-kabelschlepp.com/trademarks

Subject to change without notice.

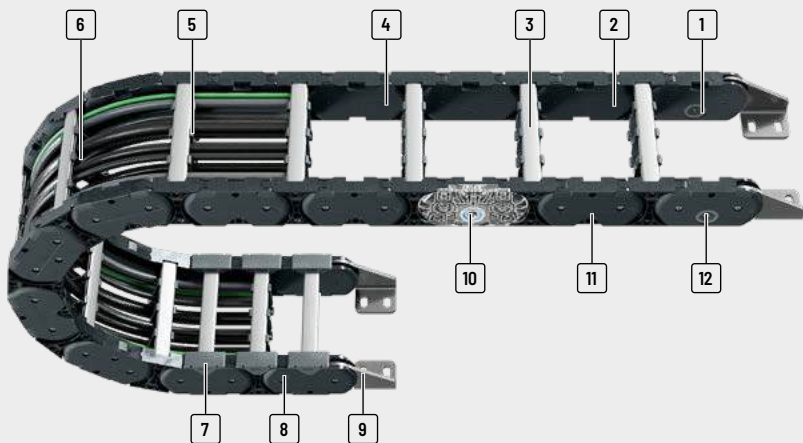

- 1 Aluminum stays available in **1 mm width sections**
- 2 Plastic chain link plates
- 3 Quick and easy opening to the inside or outside for cable laying
- 4 Cable-friendly interior – no interfering edges
- 5 Fixable dividers
- 6 Dividers and subdivision for separating the cables
- 7 Replaceable glide shoes for increased service life in gliding application
- 8 Robust, multiple stop system
- 9 End connectors made of seawater-resistant stainless steel
- 10 With integrated roll for standard guide channels
- 11 Easy replacement of chain links within the cable carrier
- 12 With roller damping

Features

- » Massive, enclosed, stain-repellent stop system
- » Massive sidebands through robust double fork-bracket-construction
- » Sidebands easy to assemble
- » Reinforced symmetrically arranged pin bore connection for better force transmission
- » Integrated noise damping
- » Quick and easy opening to the inside or outside for cable laying
- » Soil-resistant outer contour
- » Easy change of components
- » Maintenance-free
- » Linear force curve in the sideband
- » Quiet and low-wear operating through polygon-optimized contour and radii
- » Reduce drive power through less friction



Very smooth running of the roller system due to almost continuous running surface.



A non-slip structure on the running surface prevents one-sided roller wear after a standstill.



Roller chain for travel distances up to 1500 m.



RSD version with roller damping to reduce noise and wear by up to 50%.

Type	Opening variant	Stay variant	h_i [mm]	h_G [mm]	B_i [mm]	B_k [mm]	B_i - grid [mm]	t [mm]	KR [mm]	Additional load \leq [kg/m]	Cable- d_{max} [mm]
PROTUN® series											
K series											
TKHP85											
		RMF	58	84	100 - 800	154 - 854	1	85	240 - 400	50	46
UNIFLEX Advanced series											
TKHP90											
		RMF	92	117	100 - 800	170 - 870	1	90	250 - 500	100	73
M series											
TKHP85-R / TKHP85-RSD											
		RMF	58	84.5	100 - 800	154 - 854	1	85	240 - 400	50	46
XL series											
TKHP90-R / TKHP90-RSD											
		RMF	92	117.5	100 - 800	170 - 870	1	90	250 - 500	100	73
QUANTUM® series											
TKR series											
TKA series											
UAT series											

Unsupported arrangement			Gliding/Rolling arrangement			Inner Distribution				Movement			Page
Travel length ≤ [m]	$v_{max} \leq [m/s]$	$a_{max} \leq [m/s^2]$	Travel length ≤ [m]	$v_{max} \leq [m/s]$	$a_{max} \leq [m/s^2]$	TS0	TS1	TS2	TS3	vertical hanging or standing	lying on the side	rotating arrangement	
5.8	5	20	200	5	2.5	•	•	-	-	•	-	-	454
13.5	8	20	200	5	2.5	•	•	-	-	•	-	-	460
-	-	-	1200	5	50	•	•	-	-	•	-	-	466
-	-	-	1500	10	50	•	•	-	-	-	-	-	472

PROTUM® series

K series

UNIFLEX Advanced series

M series

TKHP series

XL series

QUANTUM® series

TKR series

TKA series

UAT series

TKHP85



Pitch
85 mm



Inner height
58 mm



Inner widths
100 – 800 mm



Bending radii
240 – 400 mm

Stay variants



Aluminum stay RMF page 454

Frame stay, solid

- » Aluminum profile bars for heavy loads and large cable carrier widths. Easy threaded connection.
- » **Inside/outside:** Threaded joint easy to release.



TOTALTRAX® complete systems

Benefit from the advantages of the TOTALTRAX® complete system. A complete delivery from one source – with a warranty certificate on request! Learn more at tsubaki-kabelschlepp.com/totaltrax

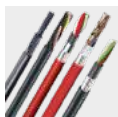

TRAXLINE® cables for cable carriers

Hi-flex electric cables which were specially developed, optimised and tested for use in cable carriers can be found at tsubaki-kabelschlepp.com/traxline.

Unsupported arrangement

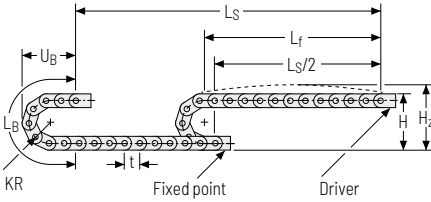

KR [mm]	H [mm]	H ₂ [mm]	L _B [mm]	U _B [mm]
240	574	704	930	300
300	694	824	1120	360
350	794	924	1270	410
400	894	1024	1430	460

Load diagram for unsupported length depending on the additional load.

Sagging of the cable carrier is technically permitted for extended travel lengths, depending on the specific application.

Intrinsic cable carrier weight $q_k = 10 \text{ kg/m}$. For other inner widths, the maximum additional load changes.

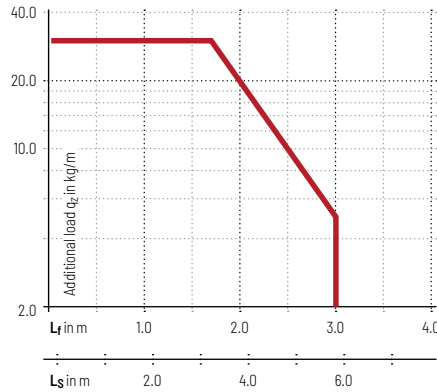

Speed
up to 5 m/s

Acceleration
up to 20 m/s²

Travel length
up to 5.9 m

Additional load
up to 30 kg/m

Gliding arrangement | GO module with chain links optimized for gliding

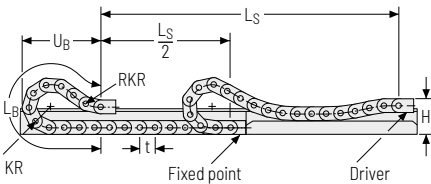

KR [mm]	H [mm]	GO module RKR [mm]	L _B [mm]	U _B [mm]	q _z max [kg/m]
240	252	500	1780	1050	60
300	252	500	2190	1270	60
350	252	500	2490	1450	40
400	252	500	2820	1630	20

Speed
up to 5 m/s

Acceleration
up to 2.5 m/s²

Travel length
up to 200 m

Additional load
up to 50 kg/m

The gliding cable carrier must be guided in a channel. See p. 846.

The GO module mounted on the driver is a defined sequence of adapted KR/RKR link plates.

Glide shoes must be used for gliding applications.

Our technical support can provide help for gliding arrangements:
technik@kabelschlepp.de

PROTUM® series
K series
UNIFLEX Advanced series
M series
TKHP series
XL series
QUANTUM® series
TKR series
TKA series
UAT series

Aluminum stay RMF – frame stay solid

- » Aluminum profile bars for heavy loads and large cable carrier widths.
- » Available customized in **1 mm grid**.
- » **Inside/outside:** Threaded joint easy to release.



Stay arrangement on every 2nd chain link, **standard unsupported (HS: half-stayed)***



Stay arrangement on each chain link (**VS: fully-stayed**)



1mm B_i 100 – 800 mm
in **1 mm width sections**

* Gliding arrangement: Inner radius fully-stayed, Outer radius half-stayed.

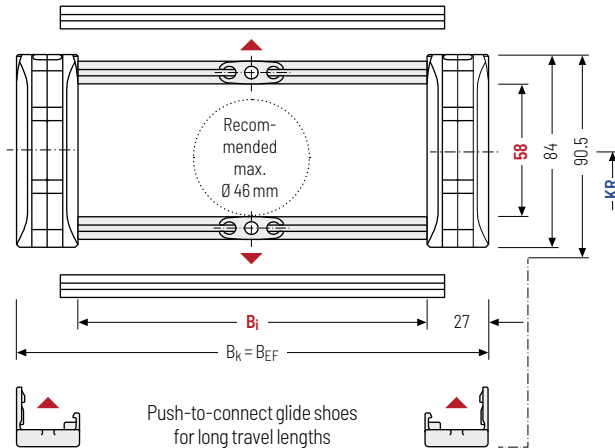

The maximum cable diameter strongly depends on the bending radius and the desired cable type. Please contact us.

Calculating the cable carrier length

Cable carrier length L_k

$$L_k \approx \frac{L_S}{2} + L_B$$

Cable carrier length L_k rounded to pitch t for odd number of chain links

h _i [mm]	h _G [mm]	h _{G'} [mm]	B _i [mm]*	B _k [mm]	B _{EF} [mm]	KR [mm]				q _k [kg/m]
58	84	90.5	100 – 800	B _i + 54	B _i + 54	240	300	350	400	6.02 – 13.12

* in 1 mm width sections

Order example



TKHP85

Type

400

B_i [mm]

RMF

Stay variant

300

KR [mm]

2125

L_k [mm]

VS

Stay arrangement

Divider systems

As a standard, the divider system is mounted on every 2nd chain link on the inside plate.

As a standard, dividers and the complete divider system (dividers with height separations) can be moved in the cross section (**version A**).

For applications with lateral acceleration and free hanging on the side, the dividers can be attached by simple insertion of a fixing profile into the RMF stay, available as an accessory (**version B**).

Divider system TSO without height separation

Vers.	a _T min [mm]	a _X min [mm]	a _C min [mm]	a _X Raster [mm]	n _T min
A	7.5/10.5*	15	11	-	-
B	7.5/10.5*	15	11	5	-

* With glide shoes

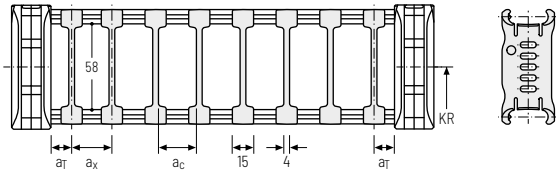

The dividers can be moved within the cross section (version A) or fixed (version B).

Divider system TS1 with continuous height separation

Vers.	a _T min [mm]	a _X min [mm]	a _C min [mm]	a _X Raster [mm]	n _T min
A	7.5/10.5*	15	11	-	2
B	7.5/10.5*	15	11	5	2

* With glide shoes

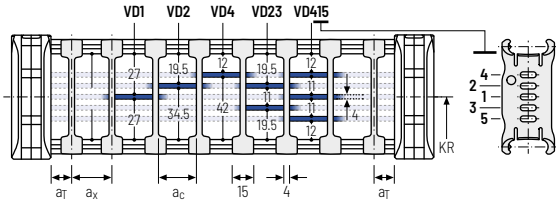

The dividers can be moved within the cross section (version A) or fixed (version B).

Order example

TS1

·

A

·

3

-

VD1

⋮

VD3

Divider system
Version
n_T
Height separation

Please state the designation of the divider system (**TS0, TS1,...**), the version, and the number of dividers per cross section [n_T].

When using divider systems with height separation (**TS1**), please additionally state the position (e.g. VD1) viewed from the left driver belt. You are welcome to add a sketch to your order.

PROTUM® series

K series

UNIFLEX Advanced series

M series

TKHP series

XL series

QUANTUM® series

TKR series

TKA series

UAT series

End connectors - steel short (standard)

The connection variants on the fixed point and on the driver can be combined and changed later on, if necessary.

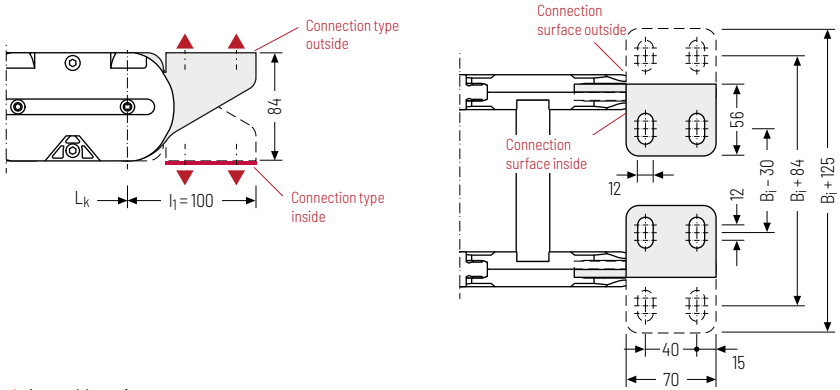

▲ Assembly options

Connection point

- F - fixed point
- M - driver

Connecting surface

- A - connecting surface outside
- I - connecting surface inside

Connection type

- A - threaded joint outside (standard)
- I - threaded joint inside

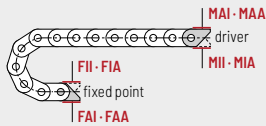

Order example



Steel	F	A	I
Steel	M	A	I
End connector	Connection point	Connection type	Connecting surface



We recommend the use of strain reliefs at the driver and fixed point. See from p. 904.

End connectors LF - steel long

The connection variants on the fixed point and on the driver can be combined and changed later on, if necessary.

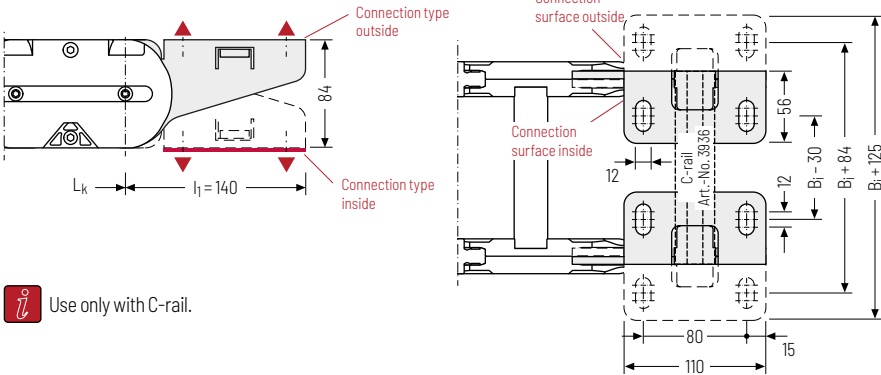

Use only with C-rail.

Assembly options

Connection point

- F - fixed point
- M - driver

Connecting surface

- A - connecting surface outside
- I - connecting surface inside

Connection type

- A - threaded joint outside (standard)
- I - threaded joint inside

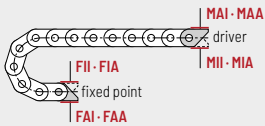

Order example

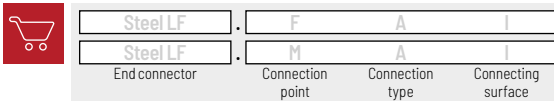

Additional product information online



Installation instructions, etc.:
Additional info via your smartphone or check online at tsubaki-kabelschlepp.com/downloads



Configure your cable carrier here:
online-engineer.de

PROTUM® series

K series

UNIFLEX Advanced series

M series

TKHP series

XL series

QUANTUM® series

TKR series

TKA series

UAT series

TKHP90



Pitch
90 mm



Inner height
92 mm



Inner widths
100 – 800 mm



Bending radii
250 – 500 mm

Stay variants



Aluminum stay RMF page 460

Frame stay, solid

- » Aluminum profile bars for heavy loads and large cable carrier widths. Easy threaded connection.
- » **Inside/outside:** Threaded joint easy to release.

PROTUM®
series

K
series

UNIFLEX
Advanced
series

M
series

TKHP
series

XL
series

QUANTUM®
series

TKR
series

TKA
series

UAT
series



TOTALTRAX® complete systems

Benefit from the advantages of the TOTALTRAX® complete system. A complete delivery from one source – with a warranty certificate on request! Learn more at tsubaki-kabelschlepp.com/totaltrax



TRAXLINE® cables for cable carriers

Hi-flex electric cables which were specially developed, optimised and tested for use in cable carriers can be found at tsubaki-kabelschlepp.com/traxline.

Unsupported arrangement

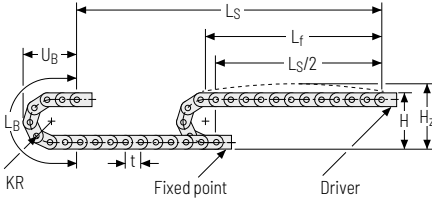

KR [mm]	H [mm]	H _z [mm]	L _B [mm]	U _B [mm]
250	675.5	860	965	510
310	795.5	980	1154	570
360	895.5	1080	1311	620
500	1175.5	1360	1751	680

Load diagram for unsupported length depending on the additional load.

Sagging of the cable carrier is technically permitted for extended travel lengths, depending on the specific application.

Intrinsic cable carrier weight $q_k = 10 \text{ kg/m}$. For other inner widths, the maximum additional load changes.

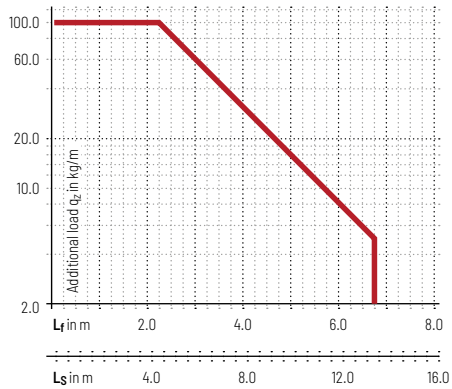

Speed
up to 8 m/s

Acceleration
up to 20 m/s^2

Travel length
up to 13.5 m

Additional load
up to 100 kg/m

Gliding arrangement | GO module with chain links optimized for gliding

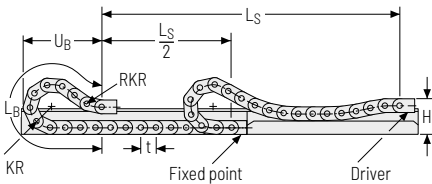

KR [mm]	H [mm]	GO module RKR [mm]	L _B [mm]	U _B [mm]	q _z max [kg/m]
250	351	600	1840	1030	100
310	351	600	2200	1230	100
360	351	600	2520	1400	90
500	351	600	3410	1880	75

Speed
up to 5 m/s

Acceleration
up to 2.5 m/s^2

Travel length
up to 200 m

Additional load
up to 100 kg/m

The gliding cable carrier must be guided in a channel. See p. 844.

The GO module mounted on the driver is a defined sequence of adapted KR/RKR link plates.

Glide shoes must be used for gliding applications.

Our technical support can provide help for gliding arrangements:
technik@kabelschlepp.de

Aluminum stay RMF – frame stay solid

- » Aluminum profile bars for heavy loads and large cable carrier widths.
- » Available customized in **1 mm grid**.
- » **Inside/outside:** Threaded joint easy to release.



Stay arrangement on every 2nd chain link, **standard unsupported (HS: half-stayed)***



Stay arrangement on each chain link (**VS: fully-stayed**)



1 mm B_i 100 – 800 mm
in **1 mm width sections**

* Gliding arrangement: Inner radius fully-stayed, Outer radius half-stayed.

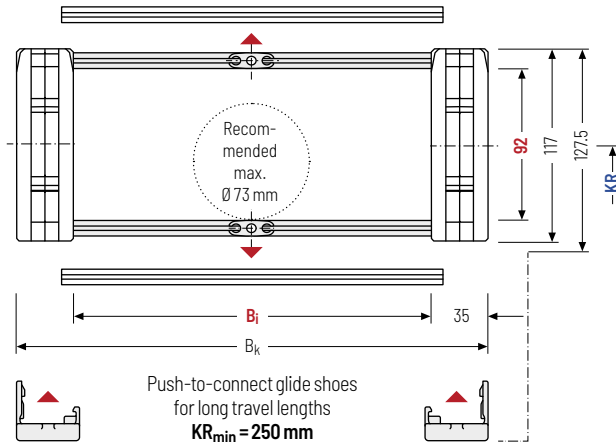

The maximum cable diameter strongly depends on the bending radius and the desired cable type. Please contact us.

Calculating the cable carrier length

Cable carrier length L_k

$$L_k \approx \frac{L_S}{2} + L_B$$

Cable carrier length L_k rounded to pitch t for odd number of chain links

h_i [mm]	h_g [mm]	h_g' [mm]	B_i [mm]*	B_k [mm]	KR [mm]			q_k [kg/m]	
92	117	127,5	100 – 800	$B_i + 70$	250	310	360	500	10.37 – 17.47

* in 1 mm width sections

Order example



TKHP90

Type

400

B_i [mm]

RMF

Stay variant

310

KR [mm]

2700

L_k [mm]

VS

Stay arrangement

Divider systems

As a standard, the divider system is mounted on every 2nd chain link on the inside plate.

For applications with lateral acceleration and free hanging on the side, the dividers can be attached by simple insertion of a fixing profile into the RMF stay, available as an accessory (**version B**).

As a standard, dividers and the complete divider system (dividers with height separations) can be moved in the cross section (**version A**).

Divider system TSO without height separation

Vers.	a _T min [mm]	a _x min [mm]	a _c min [mm]	a _x grid [mm]	n _T min
A	7.5	15	11	-	-
B	10	15	11	5	-

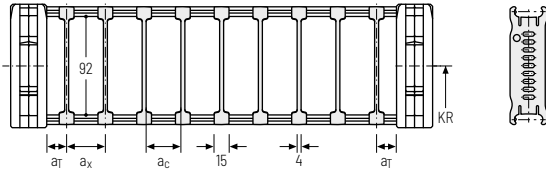

The dividers can be moved within the cross section (version A) or fixed (version B).

Divider system TS1 with continuous height separation

Vers.	a _T min [mm]	a _x min [mm]	a _c min [mm]	a _x grid [mm]	n _T min
A	7.5	15	11	-	-
B	10	15	11	5	-

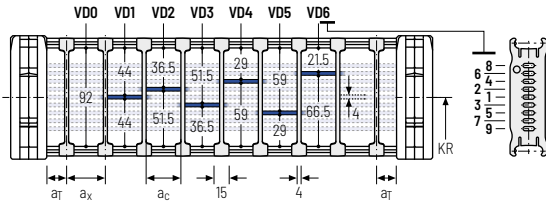

The dividers can be moved within the cross section (version A) or fixed (version B).

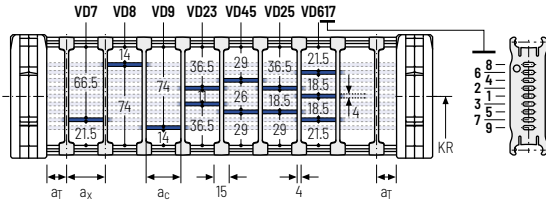

Order example

TS1

A

3

VD1

-

VD3

⋮

VD3

Divider system Version n_T Height separation

Please state the designation of the divider system (**TS0, TS1,...**), the version, and the number of dividers per cross section [n_T].

When using divider systems with height separation (**TS1**), please additionally state the position (e.g. VD1) viewed from the left driver belt. You are welcome to add a sketch to your order.

	PROTUM® series
	K series
	UNIFLEX Advanced series
	M series
	TKHP series
	XL series
	QUANTUM® series
	TKR series
	TKA series
	UAT series

End connectors - steel short (standard)

The connection variants on the fixed point and on the driver can be combined and changed later on, if necessary.

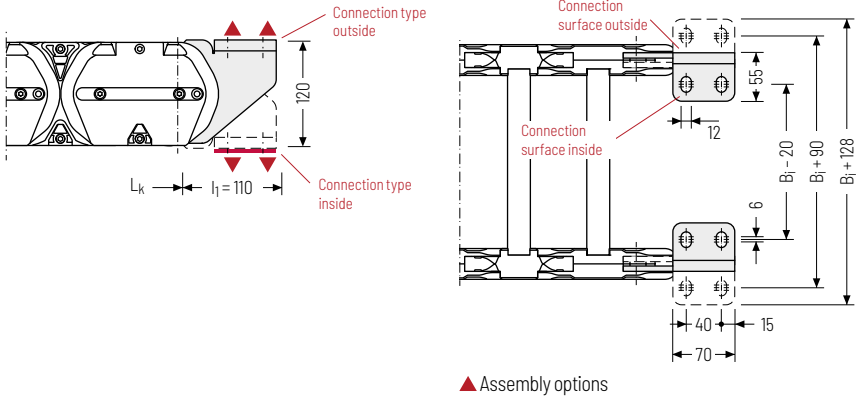

Connection point

- F** - fixed point
- M** - driver

Connecting surface

- A** - connecting surface outside
- I** - connecting surface inside

Connection type

- A** - threaded joint outside (standard)
- I** - threaded joint inside

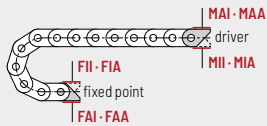

Order example

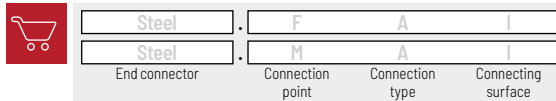

We recommend the use of strain reliefs at the driver and fixed point. See from p. 904.

End connectors LF - steel long

The connection variants on the fixed point and on the driver can be combined and changed later on, if necessary.

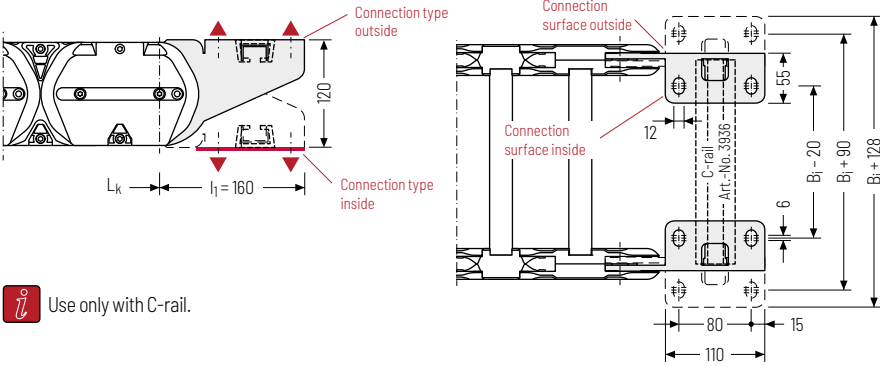

 Use only with C-rail.

▲ Assembly options

- | | | |
|-------------------------|--------------------------------|---------------------------------------|
| Connection point | Connecting surface | Connection type |
| F - fixed point | A - connecting surface outside | A - threaded joint outside (standard) |
| M - driver | I - connecting surface inside | I - threaded joint inside |

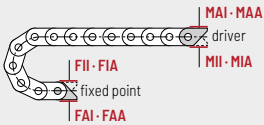

Order example

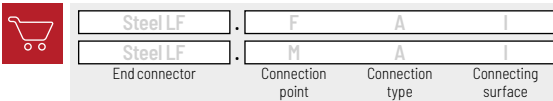

Additional product information online



Installation instructions, etc.:
Additional info via your smartphone or check online at tsubaki-kabelschlepp.com/downloads



Configure your cable carrier here:
online-engineer.de

PROTUM® series
K series
UNIFLEX Advanced series
M series
TKHP series
XL series
QUANTUM® series
TKR series
TKA series
UAT series

TKHP85-R

TKHP85-RSD

High-Performance cable carrier with integrated roller



Pitch
85 mm



Inner height
58 mm



Inner widths
100 – 800 mm



Bending radii
240 – 400 mm

Stainless steel ball bearings with application-specific lubrication and plastic rollers ensure quiet and smooth operation. Integrated, low-wear damping systems minimize the mechanical load for the entire system.

The cable carrier type TKHP85-RSD (Shock Damping) uses roller damping. The rollers of the RSD variant are damped when they pass over each other, which reduces both the mechanical load and the noise pollution when they roll over by up to 50 %.

The use of roller damping is not always necessary. An undamped cable carrier system can also be used for low-speed applications.

- » TKHP85-R with rollers
- » TKHP85-RSD with rollers and shock absorber
- » suitable for all long travel applications
- » quiet and low-vibration operation
- » space-saving and cost-optimized
- » long service life – low maintenance
- » easy access to rollers
- » minimized loads on cable carrier and cables
- » low push and pull forces
- » high travel speed and acceleration
- » large additional loads possible
- » retrofit of existing systems
- » exchange other makes up to 100 %
- » integration of existing guide channels

Stay variants



Aluminum stay RMF page 466

Frame stay, solid

- » Aluminum profile bars for heavy loads and large cable carrier widths. Easy threaded connection.
- » **Inside/outside:** Threaded joint easy to release.

Rolling arrangement | Cable carrier with integrated roller

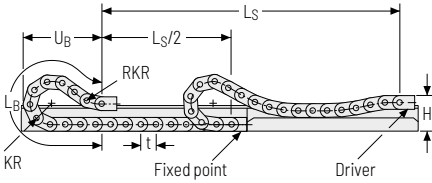

KR [mm]	H [mm]	GO module RKR [mm]	L _B [mm]	U _B [mm]	q _{z max} [kg/m]
240	252	500	1780	1050	60
300	252	500	2190	1270	60
350	252	500	2490	1450	40
400	252	500	2820	1630	20

Speed
up to 5 m/s

Acceleration
up to 50 m/s²

The rolling cable carrier must be guided in a channel. See p. 846.

Travel length
up to 1200 m

Additional load
up to 50 kg/m

The GO module mounted on the driver is a defined sequence of 4 adapted KR/RKR link plates.

Our technical support can provide help for rolling arrangements:
technik@kabelschlepp.de

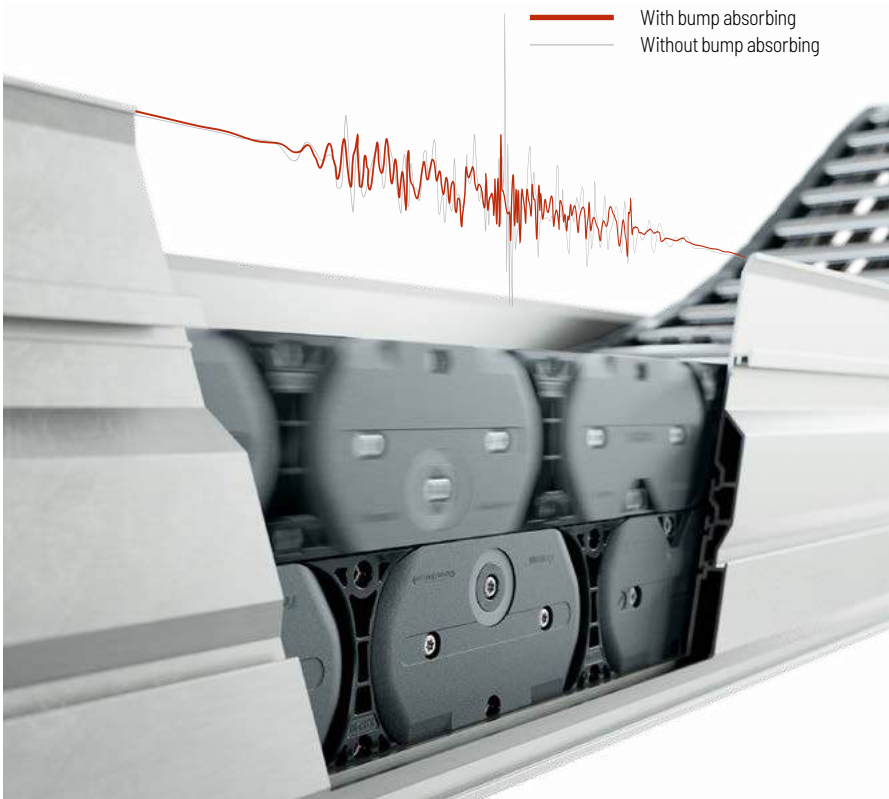

PROTUM® series
K series
UNIFLEX Advanced series
M series
TKHP series
XL series
QUANTUM® series
TKR series
TKA series
UAT series

Aluminum stay RMF - frame stay solid

- » Aluminum profile bars for heavy loads and large cable carrier widths.
- » Available customized in **1 mm grid**.
- » **Inside/outside:** Threaded joint easy to release.



Stay arrangement on every 2nd chain link, **standard (HS: half-stayed)**



Stay arrangement on each chain link (**VS: fully-stayed**)



1 mm B_i 100 - 800 mm in **1 mm width sections**

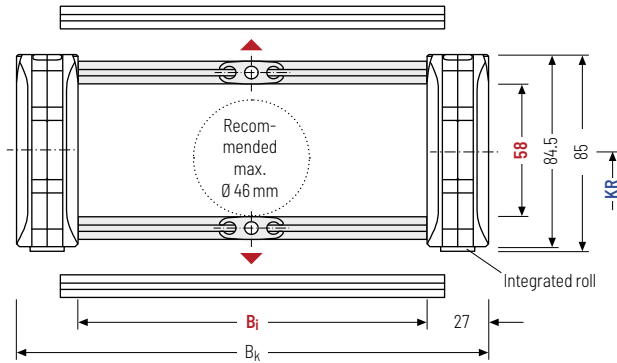

The maximum cable diameter strongly depends on the bending radius and the desired cable type. Please contact us.

Calculating the cable carrier length

Cable carrier length L_k

$$L_k \approx \frac{L_S}{2} + L_B$$

Cable carrier length L_k rounded to pitch t for odd number of chain links

h_i [mm]	h_G [mm]	h_G' [mm]	B_i [mm]*	B_k [mm]	KR [mm]				q_k [kg/m]
58	84.5	85	100 - 800	$B_i + 54$	240	300	350	400	6.02 - 13.12

* in 1 mm width sections

Order example



TKHP85-R

Type

400

B_i [mm]

RMF

Stay variant

300

KR [mm]

2125

L_k [mm]

VS

Stay arrangement

Divider systems

As a standard, the divider system is mounted on every 2nd chain link on the inside plate.

As a standard, dividers and the complete divider system (dividers with height separations) can be moved in the cross section (**version A**).

For applications with lateral acceleration and free hanging on the side, the dividers can be attached by simple insertion of a fixing profile into the RMF stay, available as an accessory (**version B**).

Divider system TSO without height separation

Vers.	a _T min [mm]	a _X min [mm]	a _C min [mm]	a _X grid [mm]	n _T min
A	7.5/10.5*	15	11	-	-
B	7.5/10.5*	15	11	5	-

* With glide shoes

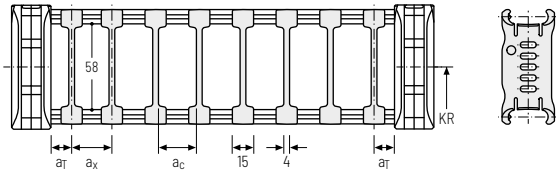

The dividers can be moved within the cross section (version A) or fixed (version B).

Divider system TS1 with continuous height separation

Vers.	a _T min [mm]	a _X min [mm]	a _C min [mm]	a _X grid [mm]	n _T min
A	7.5/10.5*	15	11	-	2
B	7.5/10.5*	15	11	5	2

* With glide shoes

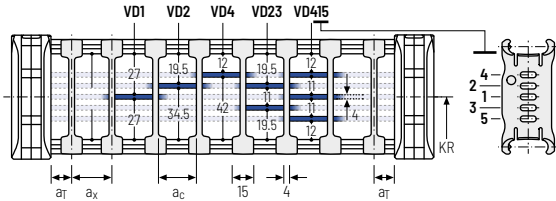

The dividers can be moved within the cross section (version A) or fixed (version B).

Order example

TS1

·

A

·

3

-

VD1

⋮

VD3

Divider system
Version
n_T
Height separation

Please state the designation of the divider system (**TS0, TS1,...**), the version, and the number of dividers per cross section [n_T].

When using divider systems with height separation (**TS1**), please additionally state the position (e.g. VD1) viewed from the left driver belt. You are welcome to add a sketch to your order.

PROTUM® series

K series

UNIFLEX Advanced series

M series

TKHP series

XL series

QUANTUM® series

TKR series

TKA series

UAT series

End connectors - steel short (standard)

The connection variants on the fixed point and on the driver can be combined and changed later on, if necessary.

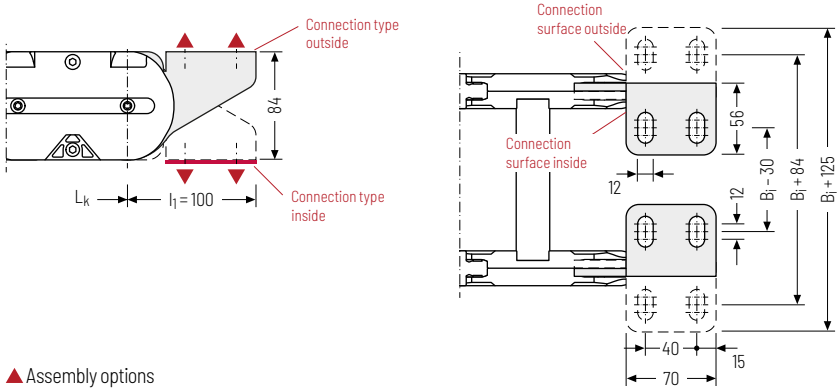

▲ Assembly options

Connection point

- F - fixed point
- M - driver

Connecting surface

- A - connecting surface outside
- I - connecting surface inside

Connection type

- A - threaded joint outside (standard)
- I - threaded joint inside

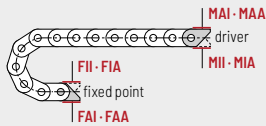

Order example



Steel	F	A	I
Steel	M	A	I
End connector	Connection point	Connection type	Connecting surface



We recommend the use of strain reliefs at the driver and fixed point. See from p. 904.

End connectors LF - steel long

The connection variants on the fixed point and on the driver can be combined and changed later on, if necessary.

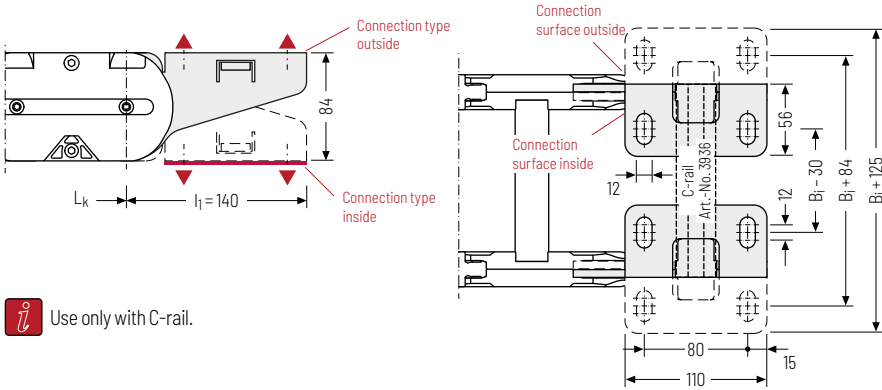

Use only with C-rail.

Assembly options

- | | | |
|-------------------------|--------------------------------|---------------------------------------|
| Connection point | Connecting surface | Connection type |
| F - fixed point | A - connecting surface outside | A - threaded joint outside (standard) |
| M - driver | I - connecting surface inside | I - threaded joint inside |

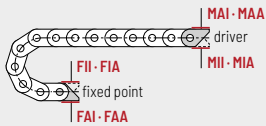

Order example

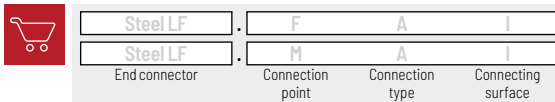

Additional product information online



Installation instructions, etc.:
Additional info via your smartphone or check online at tsubaki-kabelschlepp.com/downloads



Configure your cable carrier here:
online-engineer.de

PROTUM® series
K series
UNIFLEX Advanced series
M series
TKHP series
XL series
QUANTUM® series
TKR series
TKA series
UAT series

TKHP90-R

TKHP90-RSD

High-Performance cable carrier with integrated roller



Pitch
90 mm



Inner height
92 mm



Inner widths
100 – 800 mm



Bending radii
250 – 500 mm

Stainless steel ball bearings with application-specific lubrication and plastic rollers ensure quiet and smooth operation. Integrated, low-wear damping systems minimize the mechanical load for the entire system.

The cable carrier type TKHP90-RSD (Shock Damping) uses roller damping. The rollers of the RSD variant are damped when they pass over each other, which reduces both the mechanical load and the noise pollution when they roll over by up to 50 %.

The use of roller damping is not always necessary. An undamped cable carrier system can also be used for low-speed applications.

- » TKHP90-R with rollers
- » TKHP90-RSD with rollers and shock absorber
- » suitable for all long travel applications
- » quiet and low-vibration operation
- » space-saving and cost-optimized
- » long service life – low maintenance
- » easy access to rollers
- » minimized loads on cable carrier and cables
- » low push and pull forces
- » high travel speed and acceleration
- » large additional loads possible
- » retrofit of existing systems
- » exchange other makes up to 100 %
- » integration of existing guide channels

Stay variants



Aluminum stay RMF page 472

Frame stay, solid

- » Aluminum profile bars for heavy loads and large cable carrier widths. Easy threaded connection.
- » **Inside/outside:** Threaded joint easy to release.

Rolling arrangement | Cable carrier with integrated roller

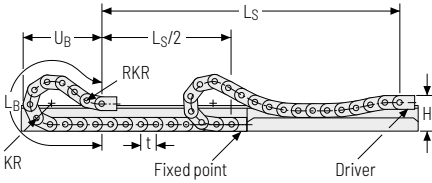

KR [mm]	H [mm]	GO module RKR [mm]	L _B [mm]	U _B [mm]	q _{z max} [kg/m]
250	351	600	1840	1030	100
310	351	600	2200	1230	100
360	351	600	2520	1400	90
500	351	600	3410	1880	75

Speed
up to 10 m/s

Acceleration
up to 50 m/s²

The rolling cable carrier must be guided in a channel. See p. 844.

Travel length
up to 1500 m

Additional load
up to 100 kg/m

The GO module mounted on the driver is a defined sequence of 6 adapted KR/RKR link plates.

Our technical support can provide help for rolling arrangements:
technik@kabelschlepp.de

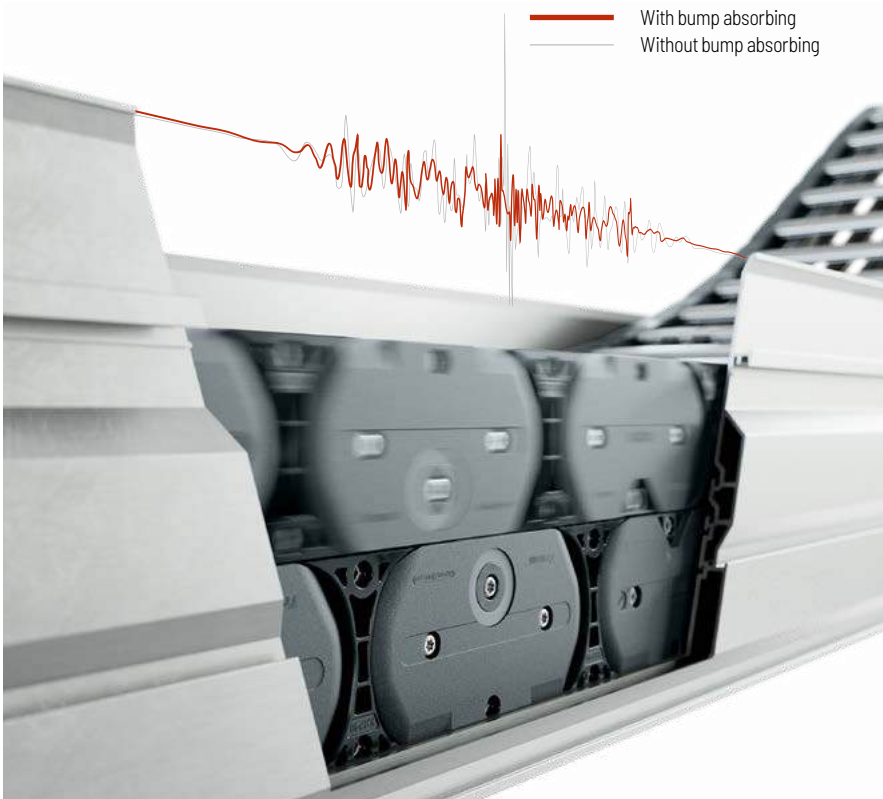

PROTUM® series
K series
UNIFLEX Advanced series
M series
TKHP series
XL series
QUANTUM® series
TKR series
TKA series
UAT series

Aluminum stay RMF - frame stay solid

- » Aluminum profile bars for heavy loads and large cable carrier widths.
- » Available customized in **1 mm grid**.
- » **Inside/outside:** Threaded joint easy to release.



Stay arrangement on every 2nd chain link, **standard (HS: half-stayed)**



Stay arrangement on each chain link (**VS: fully-stayed**)



1 mm B_i 100 - 800 mm in **1 mm width sections**

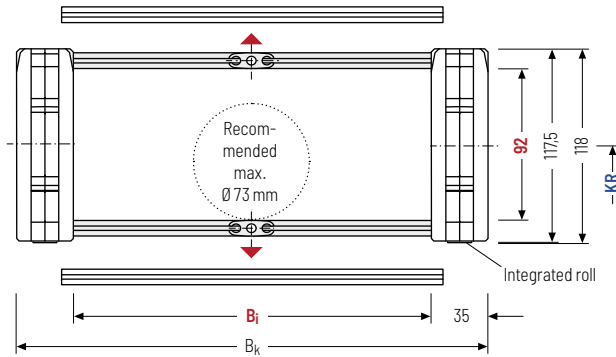

The maximum cable diameter strongly depends on the bending radius and the desired cable type. Please contact us.

Calculating the cable carrier length

Cable carrier length L_k

$$L_k \approx \frac{L_S}{2} + L_B$$

Cable carrier length L_k rounded to pitch t for odd number of chain links

h_i [mm]	h_G [mm]	h_G' [mm]	B_i [mm]*	B_k [mm]	KR [mm]			q_k [kg/m]	
92	117.5	118	100 - 800	$B_i + 70$	250	310	360	500**	10.37 - 17.47

* in 1 mm width sections ** When using this KR please contact our technical support.

Order example



TKHP90-R

Type

400

B_i [mm]

RMF

Stay variant

310

KR [mm]

2700

L_k [mm]

VS

Stay arrangement

Divider systems

As a standard, the divider system is mounted on every 2nd chain link on the inside plate.

For applications with lateral acceleration and free hanging on the side, the dividers can be attached by simple insertion of a fixing profile into the RMF stay, available as an accessory (**version B**).

As a standard, dividers and the complete divider system (dividers with height separations) can be moved in the cross section (**version A**).

Divider system TSO without height separation

Vers.	a _T min [mm]	a _x min [mm]	a _c min [mm]	a _x grid [mm]	n _T min
A	7.5	15	11	-	-
B	10	15	11	5	-

The dividers can be moved within the cross section (version A) or fixed (version B).

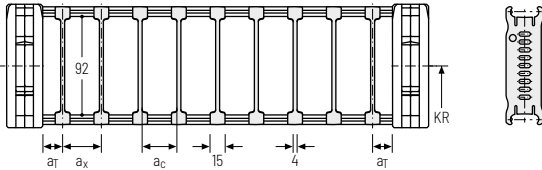

Divider system TS1 with continuous height separation

Vers.	a _T min [mm]	a _x min [mm]	a _c min [mm]	a _x grid [mm]	n _T min
A	7.5	15	11	-	-
B	10	15	11	5	-

The dividers can be moved within the cross section (version A) or fixed (version B).

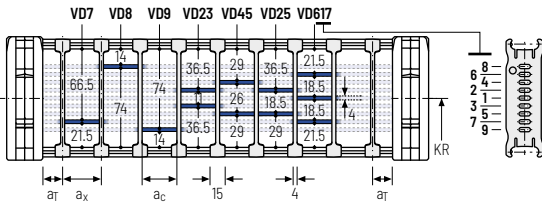
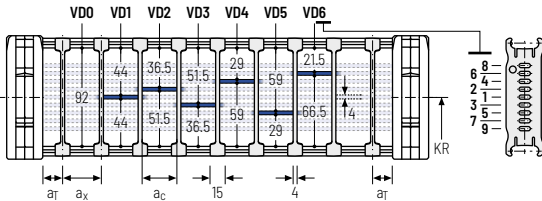

Order example

TS1

A

3

VD1

-

⋮

VD3

-

Divider system

Version

n_T

Height separation

Please state the designation of the divider system (**TS0, TS1,...**), the version, and the number of dividers per cross section [n_T].

When using divider systems with height separation (**TS1**), please additionally state the position (e.g. VD1) viewed from the left driver belt. You are welcome to add a sketch to your order.

PROTUM® series
K series
UNIFLEX Advanced series
M series
TKHP series
XL series
QUANTUM® series
TKR series
TKA series
UAT series

End connectors - steel short (standard)

The connection variants on the fixed point and on the driver can be combined and changed later on, if necessary.

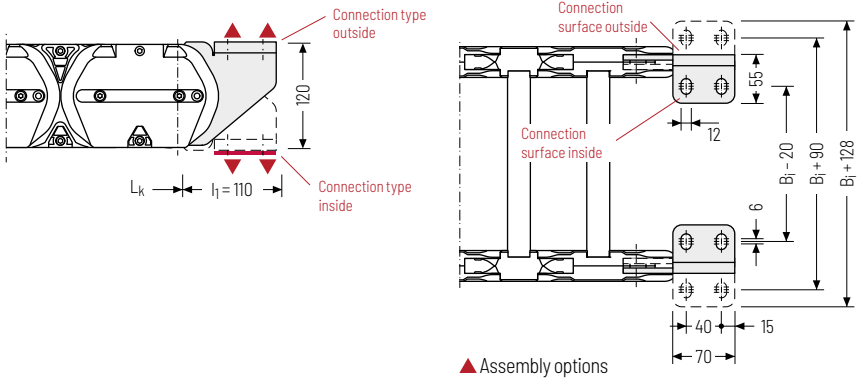

Connection point

F - fixed point
M - driver

Connecting surface

A - connecting surface outside
I - connecting surface inside

Connection type

A - threaded joint outside (standard)
I - threaded joint inside

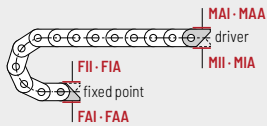

Order example



Steel	F	A	I
Steel	M	A	I
End connector	Connection point	Connection type	Connecting surface



We recommend the use of strain reliefs at the driver and fixed point. See from p. 844.

End connectors LF - steel long

The connection variants on the fixed point and on the driver can be combined and changed later on, if necessary.

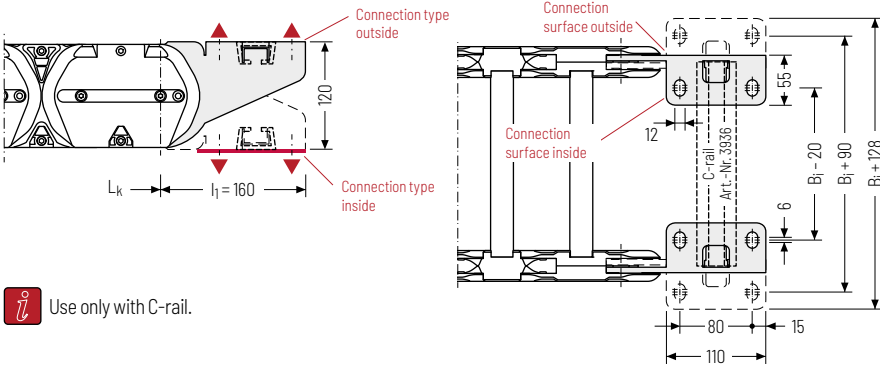

Use only with C-rail.

▲ Assembly options

Connection point

- F - fixed point
- M - driver

Connecting surface

- A - connecting surface outside
- I - connecting surface inside

Connection type

- A - threaded joint outside (standard)
- I - threaded joint inside

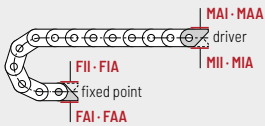

Order example

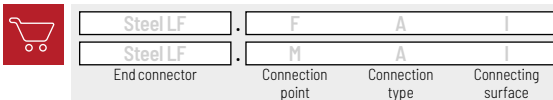

Additional product information online



Installation instructions, etc.:
Additional info via your smartphone or check online at tsubaki-kabelschlepp.com/downloads



Configure your cable carrier here:
online-engineer.de

PROTUM® series

K series

UNIFLEX Advanced series

M series

TKHP series

XL series

QUANTUM® series

TKR series

TKA series

UAT series