

# UNIFLEX *Advanced* series

Light, quiet all-rounder with a  
wide range of applications\*



\* Some features can be different  
for certain types for design reasons.

Trademarks are legally protected for the TSUBAKI KABELSCHLEPP GmbH as  
a national or international registration in the following countries:  
[tsubaki-kabelschlepp.com/trademarks](http://tsubaki-kabelschlepp.com/trademarks)

Subject to change without notice.

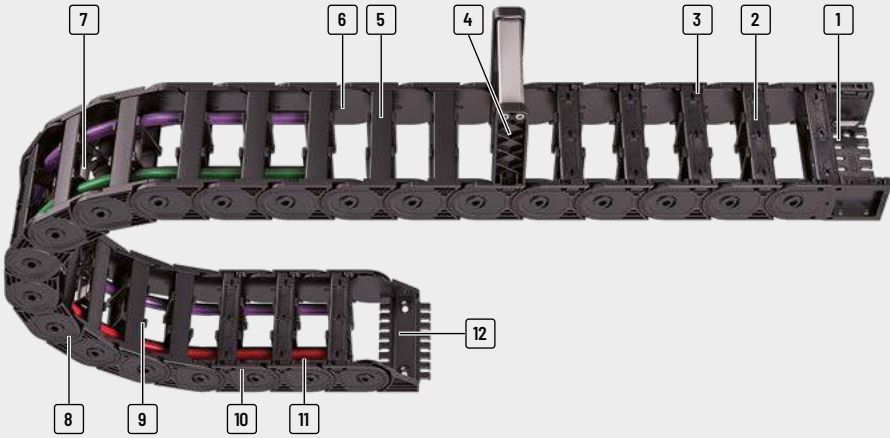

- 1 Universal mounting bracket (UMB) with integratable strain relief comb
- 2 Designs with inside or outside opening stays
- 3 Extremely fast and easy to open due to ball joint mechanism
- 4 Top-mounted frame stay
- 5 Single-part links (type 020)
- 6 Favourable ratio of inner to outer width
- 7 Many separation options for the cables
- 8 Robust double-stroke system for long unsupported lengths
- 9 Easy divider fixing
- 10 Very quiet through integrated noise damping
- 11 Lateral wear surfaces
- 12 Single-part end connectors with integratable strain relief comb

## Features

- » Extensive unsupported lengths
- » High torsional rigidity
- » Good ratio of inner to outer width
- » Numerous custom material types for custom applications available
- » Easy assembly and fast cable laying
- » Assembly tools available
- » Stays with ball joint opening on both sides
- » Many possibilities for internal subdivision
- » Wear surfaces for gliding applications with extended travel lengths



**Fixable dividers for arrangements rotated by 90° and applications with high lateral accelerations – no additional spacers required**



**Lateral wear surfaces – for long service life for applications where the carrier is rotated through 90°**



**Simple fixing of strain relief comb or C-Rail in the connector**

Cable carrier

Cable carrier configuration

Configuration guidelines

Materials information

MONO series

QuickTrax® series

UNIFLEX  
Advanced series

TKP35 series

TKK series

EasyTrax® series

	Type	Opening variant	Stay variant	$h_i$ [mm]	$h_G$ [mm]	$B_i$ [mm]	$B_k$ [mm]	$B_i$ - grid [mm]	t [mm]	KR [mm]	Additional load ≤ [kg/m]	Cable- $d_{max}$ [mm]
Cable carrier												
Cable carrier configuration	<b>UA1250</b>		020	17.5	23	30 - 50	60	-	25	28 - 100	4	14
Configuration guidelines												
Materials information	<b>UA1320</b>		020	20	25.5	15 - 65	27 - 77	-	32	28 - 125	3.0	16
MONO series	<b>UA1455</b>		020	26	36	25 - 130	41 - 146	-	45.5	52 - 200	6	20.5
QuickTrax® series			030	26	36	25 - 130	41 - 146	-	45.5	52 - 200	6	20.5
			040	26	36	25 - 130	41 - 146	-	45.5	52 - 200	6	20.5
UNIFLEX Advanced series			020	38	50	50 - 150	68 - 168	-	55.5	63 - 200	10	30
			030	38	50	50 - 150	68 - 168	-	55.5	63 - 200	10	30
			040	38	50	50 - 150	68 - 168	-	55.5	63 - 200	10	30
TKP35 series			020	44	60	50 - 250	72 - 272	-	66.5	75 - 300	15	35
			030	44	60	50 - 250	72 - 272	-	66.5	75 - 300	15	35
			040	44	60	50 - 250	72 - 272	-	66.5	75 - 300	15	35
TKK series			RMA	44 (114-189)	60 (170-245)	125 - 200	147 - 222	1	66.5	75 - 300	15	35/151
EasyTrax® series												

Unsupported arrangement			Gliding arrangement			Inner Distribution				Movement			Page
Travel length ≤ [m]	$v_{max} \leq [m/s]$	$a_{max} \leq [m/s^2]$	Travel length ≤ [m]	$v_{max} \leq [m/s]$	$a_{max} \leq [m/s^2]$	TS0	TS1	TS2	TS3	vertical hanging or standing	lying on the side	rotating arrangement	
16	10	50	60	3	30	•	-	-	-	•	•	•	152
2.9	10	50	80	2.5	25	•	-	-	-	•	•	•	158
4.8	10	50	120	2.5	20	•	-	-	•	•	•	•	164
4.8	10	50	120	2.5	20	•	•	-	•	•	•	•	165
4.8	10	50	-	-	-	•	•	-	•	•	•	•	166
6.3	9	45	125	3	20	•	-	-	•	•	•	•	174
6.3	9	45	125	3	20	•	•	-	•	•	•	•	175
6.3	9	45	-	-	-	•	•	-	•	•	•	•	176
7	8	40	150	3	15	•	-	-	•	•	•	•	184
7	8	40	150	3	15	•	•	-	•	•	•	•	185
7	8	40	-	-	-	•	•	-	•	•	•	•	186
7	8	40	150	3	15	•	•	-	•	•	•	-	188

Subject to change without notice.

Cable carrier

Cable carrier configuration

Configuration guidelines

Materials information

MONO series









QuickTrax® series

**UNIFLEX**  
Advanced series

TKP35 series

TKK series

EasyTrax® series

Type	Opening variant	Stay variant	$h_i$	$h_G$	$B_i$	$B_k$	$B_i$ - grid	$t$	$KR$	Additional load $\leq$ [kg/m]	Cable- $d_{max}$ [mm]
			[mm]	[mm]	[mm]	[mm]	[mm]	[mm]	[mm]		
<b>UA1775</b>											
		020	56	77	100 - 400	126 - 476	-	77.5	90 - 340	25	44
		030	56	77	100 - 400	126 - 476	-	77.5	90 - 340	25	44
		040	56	77	100 - 400	126 - 476	-	77.5	90 - 340	25	44
<b>UA1995</b>											
		020	80	110	85 - 250	115 - 280	-	99.5	150 - 500	50	64
		030	80	110	85 - 250	115 - 280	-	99.5	150 - 500	50	64
		040	80	110	85 - 250	115 - 280	-	99.5	150 - 500	50	64
		070	80	110	85 - 250	115 - 280	-	99.5	150 - 500	50	64

Cable carrier

Cable carrier  
configurationConfiguration  
guidelinesMaterials  
informationMONO  
seriesQuickTrax®  
seriesUNIFLEX  
Advanced  
seriesTKP35  
seriesTKK  
seriesEasyTrax®  
series

Unsupported arrangement			Gliding arrangement			Inner Distribution				Movement			Page
Travel length ≤ [m]	$v_{max} \leq [m/s]$	$a_{max} \leq [m/s^2]$	Travel length ≤ [m]	$v_{max} \leq [m/s]$	$a_{max} \leq [m/s^2]$	TS0	TS1	TS2	TS3	vertical hanging or standing	lying on the side	rotating arrangement	
7.8	10	35	200	3	8	•	-	-	•	•	•	•	196
7.8	10	35	200	3	8	•	•	-	•	•	•	•	197
7.8	10	35	200	3	8	•	•	-	•	•	•	•	198
9	10	25	200	8	20	•	-	-	•	•	•	•	204
9	10	25	200	8	20	•	•	-	•	•	•	•	205
9	10	25	200	8	20	•	•	-	•	•	•	•	206
9	10	25	200	8	200	•	•	-	•	•	•	•	207

Cable carrier

Cable carrier configuration

Configuration guidelines

Materials information

MONO series

QuickTrax® series

**UNIFLEX Advanced series**

TKP35 series

TKK series

EasyTrax® series

# UA1250



**Pitch**  
25 mm



**Inner height**  
17,5 mm



**Inner widths**  
30 – 50 mm



**Bending radii**  
28 – 100 mm

## Stay variants



**Design 020** ..... page 158

### Closed frame

- » Weight-optimised, closed plastic frame with particularly high torsional rigidity.
- » **Outside/inside:** not openable.



### QuickTrax® | EasyTrax®

For an openable cable carrier with 16.5 – 17.6 mm inner height we recommend the series QuickTrax® 0250 or EasyTrax® 0250 **QT0250 from page 132** and **ET0250 from page 244**.

Unsupported arrangement

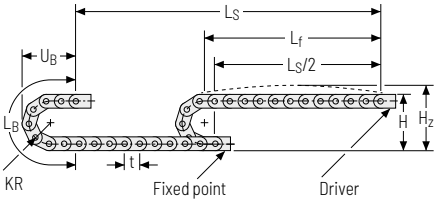

KR [mm]	H [mm]	H <sub>2</sub> [mm]	L <sub>B</sub> [mm]	U <sub>B</sub> [mm]
28	79	104	138	65
38	99	124	169	75
45	113	138	191	82
60	143	168	238	97
75	173	198	286	112
100	223	248	364	137

Load diagram for unsupported length depending on the additional load.

Sagging of the cable carrier is technically permitted for extended travel lengths, depending on the specific application.

Intrinsic cable carrier weight  $q_k = 0.36 \text{ kg/m}$  with  $B_i 50 \text{ mm}$ . For other inner widths, the maximum additional load changes.

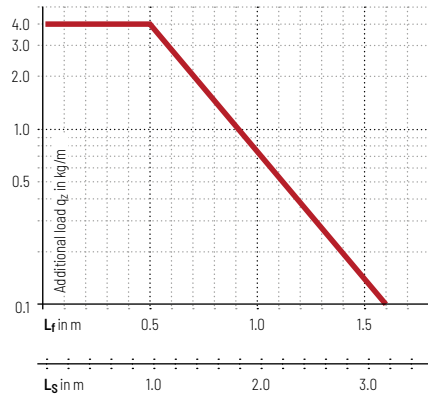

- Speed**  
up to 10 m/s
- Acceleration**  
up to  $50 \text{ m/s}^2$
- Travel length**  
up to 1.6 m
- Additional load**  
up to 4 kg/m

Gliding arrangement

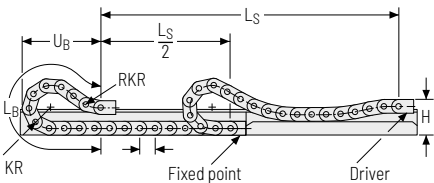

- Speed**  
up to 3 m/s
- Acceleration**  
up to  $30 \text{ m/s}^2$
- Travel length**  
up to 60 m
- Additional load**  
up to 4kg/m

The gliding cable carrier must be guided in a channel. See p. 844.

Cable carrier
Cable carrier configuration
Configuration guidelines
Materials information
MONO series
QuickTrax® series
<b>UNIFLEX</b> Advanced series
TKP35 series
TKK series
EasyTrax® series



## Stay variant 020 – closed frame

- » Weight-optimised, closed plastic frame with particularly high torsional rigidity.
- » **Outside/inside:** not openable.



Stay arrangement on each chain link (**VS: fully-stayed**)



$B_i$ : 30 – 50 mm

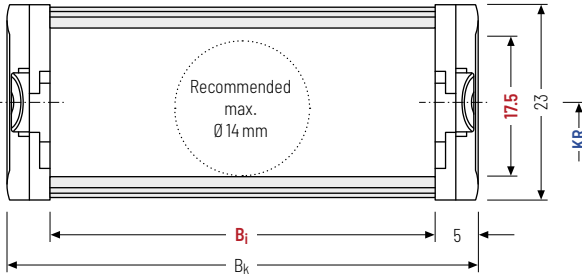

The maximum cable diameter strongly depends on the bending radius and the desired cable type. Please contact us.

### Calculating the cable carrier length

#### Cable carrier length $L_k$

$$L_k \approx \frac{L_S}{2} + L_B$$

Cable carrier length  $L_k$   
rounded to pitch  $t$

$h_i$ [mm]	$h_g$ [mm]	$B_i$ [mm]	$B_k$ [mm]	KR [mm]						$q_k$ [kg/m]
17.5	23	30* 50	$B_i + 10$	28	38	45	60	75	100	0.32 – 0.36

\* on request

### Order example



UA1250

Type

020

Stay variant

50

$B_i$  [mm]

75

KR [mm]

1100

$L_k$  [mm]

VS

Stay arrangement

**Divider systems**

The divider system is mounted on every 2<sup>nd</sup> chain link as a standard.

As a standard, dividers or the complete divider system (dividers with height separations) are movable in the cross section (**version A**).

For applications with lateral accelerations and applications with the cable carrier rotated by 90°, the dividers can easily be fixed on the stay through rotation. The arresting cams snap into the catch profiles in the covers (**version B**).

**Divider system TSO without height separation**

Vers.	a <sub>T</sub> min [mm]	a <sub>x</sub> min [mm]	a <sub>c</sub> min [mm]	a <sub>x</sub> grid [mm]	n <sub>T</sub> min
A	3	6	4	-	-
B	3	6	4	2	-

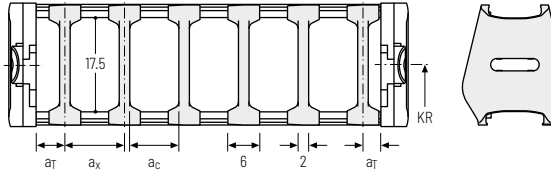

**Order example**

TSO
·
A
·
3

Divider system
Version
n<sub>T</sub>

Please state the designation of the divider system (TSO), the version, and the number of dividers per cross section [n<sub>T</sub>]. You are welcome to add a sketch to your order.

Cable carrier

Cable carrier configuration

Configuration guidelines

Materials information

MONO series

QuickTrax® series

**UNIFLEX**  
Advanced series

TKP35 series

TKK series

EasyTrax® series

**Additional product information online**



Installation instructions, etc.:  
Additional info via your smartphone or check online at [tsubaki-kabelschlepp.com/downloads](http://tsubaki-kabelschlepp.com/downloads)



Configure your cable carrier here:  
[online-engineer.de](http://online-engineer.de)

## Single-part end connectors – plastic (with integrated strain relief)

The plastic end connectors can be connected **from above or below**. The connection type can be changed by altering the position of the end connector.

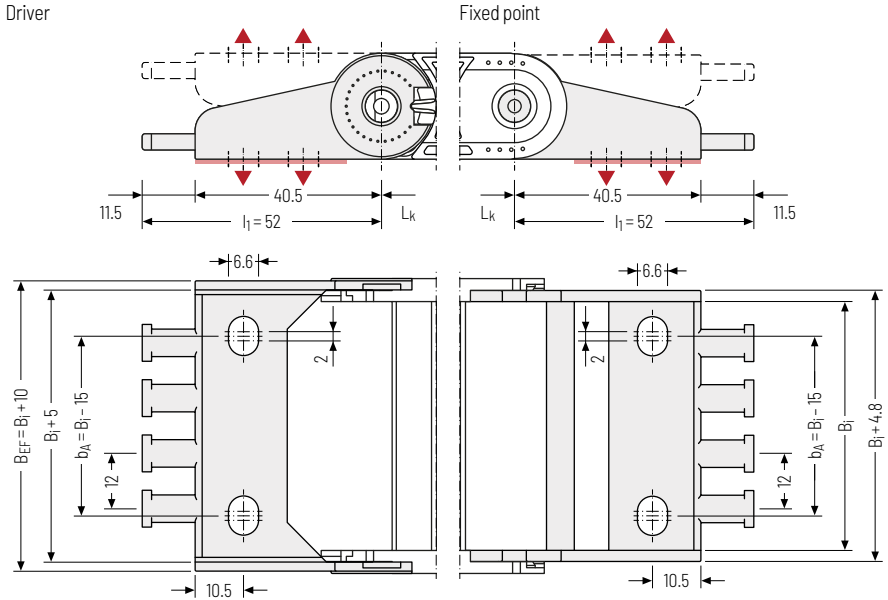

### ▲ Assembly options

$B_i$ [mm]	$B_{EF}$ [mm]	$n_z$
30	40	2
50	60	4

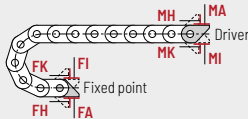

### Connection point

- F – fixed point
- M – driver

### Connection type

- A – threaded joint outside (standard)
- I – threaded joint inside
- H – threaded joint, rotated 90° to the outside
- K – threaded joint, rotated 90° to the inside

### Order example

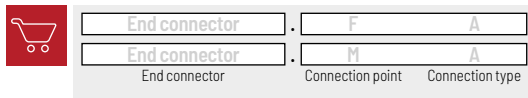



EasyTrax®  
series

TKK  
series

TKP35  
series

**UNIFLEX**  
Advanced  
series

QuickTrax®  
series

MONO  
series

Materials  
information

Configuration  
guidelines

Cable carrier  
configuration

Cable carrier

# UA1320



**Pitch**  
32 mm



**Inner height**  
20 mm



**Inner widths**  
15 - 65 mm



**Bending radii**  
28 - 125 mm

## Stay variants



**Design 020** ..... page 158

### Closed frame

- » Weight-optimised, closed plastic frame with particularly high torsional rigidity.
- » **Outside/inside:** not openable.

Cable carrier

Cable carrier configuration

Configuration guidelines

Materials information

MONO series

QuickTrax® series

UNIFLEX  
Advanced series

TKP35 series

TKK series

EasyTrax® series



### QuickTrax® | EasyTrax®

For an openable cable carrier with 18 - 20 mm inner height we recommend the series QuickTrax® 0320 or EasyTrax® 0320 **QT0320 from page 138** and **ET0320 from page 250**.

Unsupported arrangement

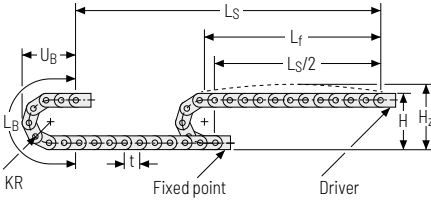





KR [mm]	H [mm]	H <sub>2</sub> [mm]	L <sub>B</sub> [mm]	U <sub>B</sub> [mm]
28	81.5	98.5	152	73
38	101.5	118.5	184	83
48	121.5	138.5	215	93
75	175.5	192.5	300	120
100	225.5	242.5	379	145
125	275.5	292.5	457	170

**Load diagram for unsupported length** depending on the additional load.

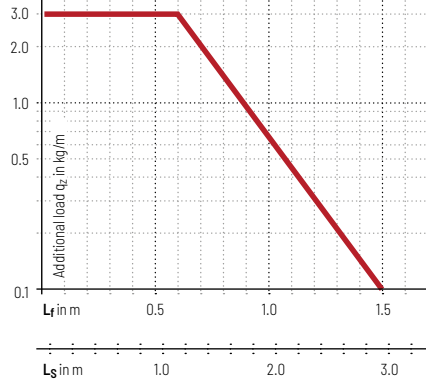
Sagging of the cable carrier is technically permitted for extended travel lengths, depending on the specific application.





Intrinsic cable carrier weight  $q_k = 0.40 \text{ kg/m}$  with  $B_i 50 \text{ mm}$ . For other inner widths, the maximum additional load changes.

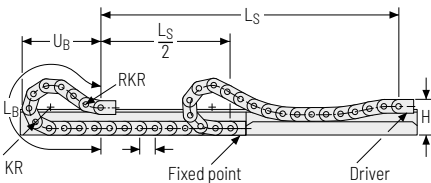

-  **Speed**  
up to 10 m/s
-  **Acceleration**  
up to  $50 \text{ m/s}^2$
-  **Travel length**  
up to 2.9 m
-  **Additional load**  
up to 3 kg/m

Gliding arrangement



-  **Speed**  
up to 2.5 m/s
-  **Acceleration**  
up to  $25 \text{ m/s}^2$
-  **Travel length**  
up to 80 m
-  **Additional load**  
up to 3 kg/m

 The gliding cable carrier must be guided in a channel. See p. 844.

Cable carrier
Cable carrier configuration
Configuration guidelines
Materials information
MONO series
QuickTrax® series
<b>UNIFLEX</b> Advanced series
TKP35 series
TKK series
EasyTrax® series

## Stay variant 020 – closed frame

- » Weight-optimised, closed plastic frame with particularly high torsional rigidity.
- » **Outside/inside:** not openable.



Stay arrangement on each chain link (**VS: fully-stayed**)



$B_i$  15 – 65 mm

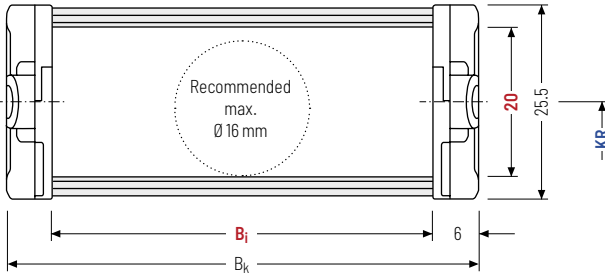

The maximum cable diameter strongly depends on the bending radius and the desired cable type. Please contact us.

### Calculating the cable carrier length

#### Cable carrier length $L_k$

$$L_k \approx \frac{L_S}{2} + L_B$$

Cable carrier length  $L_k$   
rounded to pitch  $t$

$h_i$ [mm]	$h_g$ [mm]	$B_i$ [mm]				$B_k$ [mm]		$KR$ [mm]				$q_k$ [kg/m]		
20	25.5	15	25	38	50	65	$B_i + 12$	28	38	48	75	100	125	0.36 – 0.48

### Order example



UA1320

Type

020

Stay variant

50

$B_i$  [mm]

100

$KR$  [mm]

960

$L_k$  [mm]

VS

Stay arrangement

**Divider systems**

The divider system is mounted on every 2<sup>nd</sup> chain link as a standard.

As a standard, dividers or the complete divider system (dividers with height separations) are movable in the cross section (**version A**).

**Divider system TSO without height separation**

Vers.	a <sub>T</sub> min [mm]	a <sub>x</sub> min [mm]	a <sub>c</sub> min [mm]	n <sub>T</sub> min
A	4	8	6	-

The dividers can be moved in the cross section.

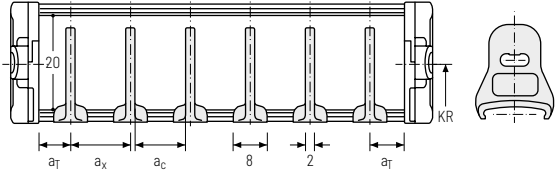

**Order example**

TS1
A
3

Divider system · Version · n<sub>T</sub>

Please state the designation of the divider system (**TSO**), the version, and the number of dividers per cross section [n<sub>T</sub>]. You are welcome to add a sketch to your order.

Cable carrier
Cable carrier configuration
Configuration guidelines
Materials information
MONO series
QuickTrax® series
<b>UNIFLEX</b> Advanced series
TKP35 series
TKK series
EasyTrax® series



## Single-part end connectors – plastic (with integrated strain relief)

The plastic end connectors can be connected from above or below. The connection type can be changed by altering the position of the end connector.

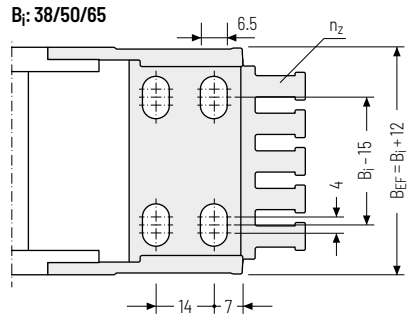
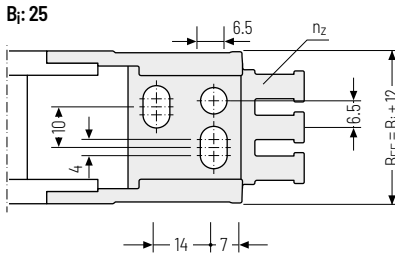
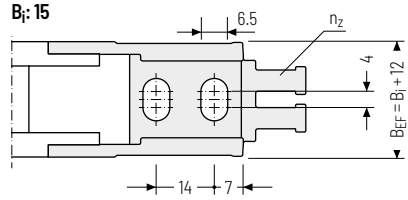
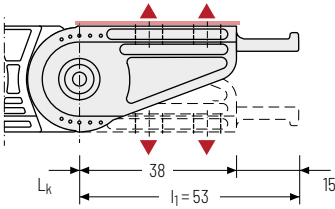

### ▲ Assembly options

$B_i$ [mm]	$B_{EF}$ [mm]	$n_z$
15	27	2
25	37	3
38	50	4
50	62	5
65	77	6

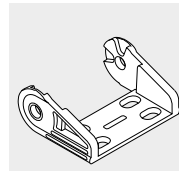

The end connectors are also available as an option **without** integrated strain relief. Please state when ordering.

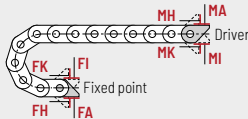

### Connection point

- F** – fixed point
- M** – driver

### Connection type

- A** – threaded joint outside (standard)
- I** – threaded joint inside
- H** – threaded joint, rotated 90° to the outside
- K** – threaded joint, rotated 90° to the inside

### Order example

	End connector	F	A
	End connector	M	A
	End connector	Connection point	Connection type

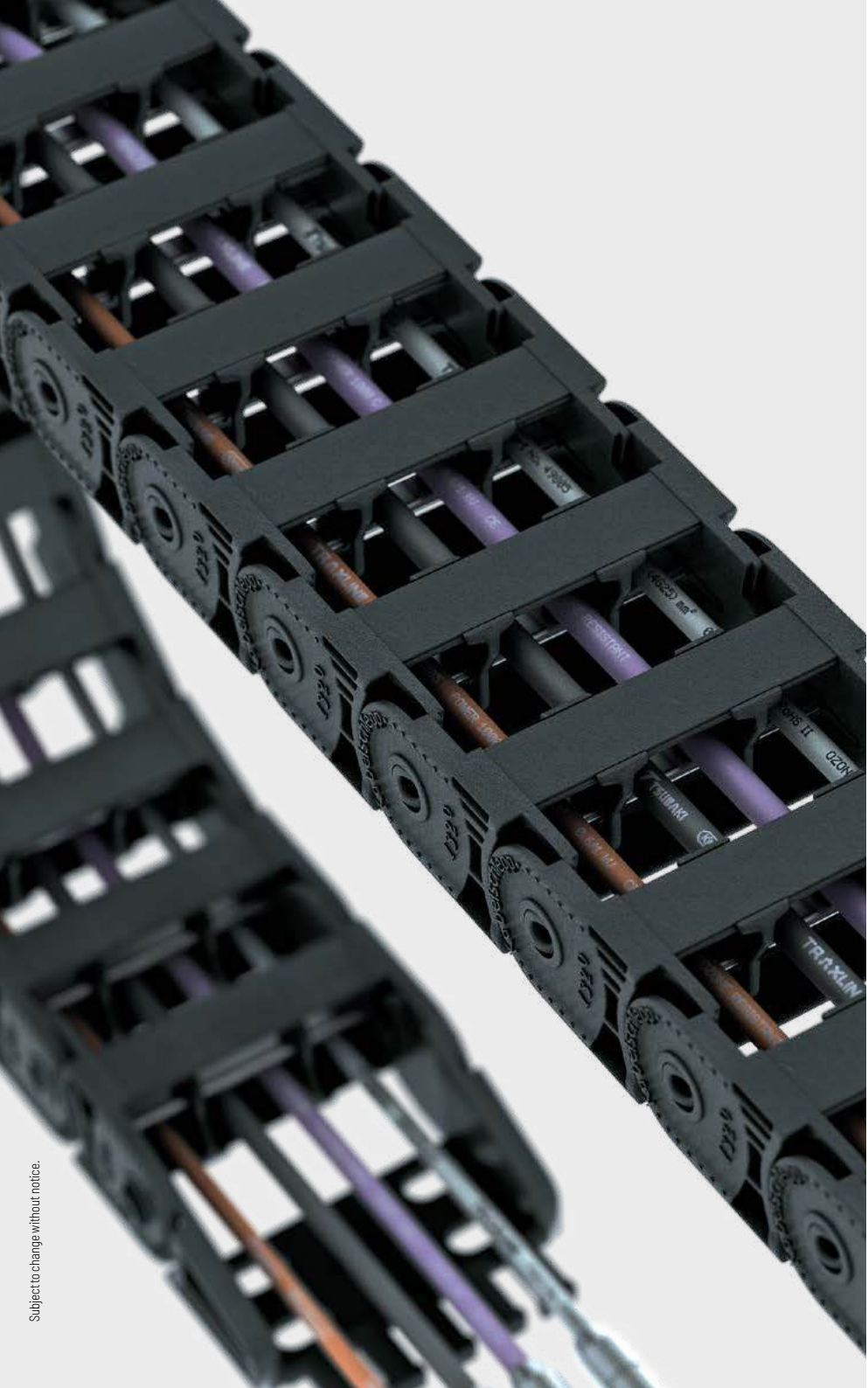

EasyTrax®  
series

TKK  
series

TKP35  
series

**UNIFLEX**  
Advanced  
series

QuickTrax®  
series

MONO  
series

Materials  
information

Configuration  
guidelines

Cable carrier  
configuration

Cable carrier

# UA1455



**Pitch**  
45.5 mm



**Inner height**  
26 mm



**Inner widths**  
25 – 130 mm



**Bending radii**  
52 – 200 mm

## Stay variants



**Design 020** ..... page 164

### Closed frame

- » Weight-optimised, closed plastic frame with particularly high torsional rigidity.
- » **Outside/inside:** not openable.



**Design 030** ..... page 165

### Frame with outside detachable stays

- » Weight-optimised plastic frame with particularly high torsional rigidity.
- » **Outside:** openable and detachable.



**Design 040** ..... page 166

### Frame with inside detachable stays

- » Weight-optimised plastic frame with particularly high torsional rigidity.
- » **Inside:** openable and detachable.



### EasyTrax®

For an openable cable carrier with 25 mm inner height we recommend the series EasyTrax® 1455 **ET1455 from page 256.**

Unsupported arrangement

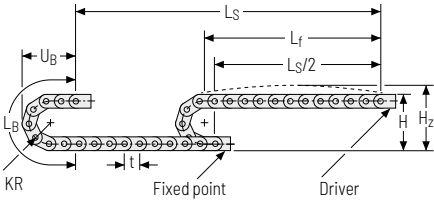

KR [mm]	H [mm]	H <sub>2</sub> [mm]	L <sub>B</sub> [mm]	U <sub>B</sub> [mm]
52	140	165	255	116
65	166	191	296	129
95	226	251	390	159
125	286	311	484	189
150	336	361	563	214
180	396	421	657	244
200	436	461	720	264

Load diagram for unsupported length depending on the additional load.

Sagging of the cable carrier is technically permitted for extended travel lengths, depending on the specific application.

Intrinsic cable carrier weight  $q_k = 0.75 \text{ kg/m}$  with  $B_3$  38 mm. For other inner widths, the maximum additional load changes.

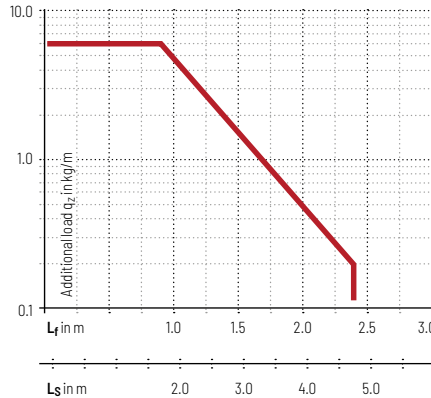

- Speed**  
up to 10 m/s
- Acceleration**  
up to 50 m/s<sup>2</sup>
- Travel length**  
up to 4.8 m
- Additional load**  
up to 6 kg/m

Gliding arrangement | GO module with chain links optimized for gliding

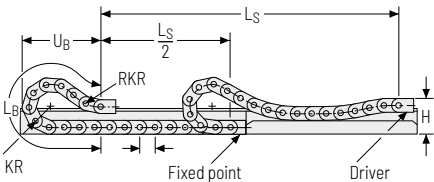

KR [mm]	H [mm]	GO-Modul RKR [mm]	L <sub>B</sub> [mm]	U <sub>B</sub> [mm]
52	108	225	780	377
65	108	225	825	389
95	108	225	1007	450
125	108	225	1189	508
150	108	225	1371	573
180	108	225	1599	655
200	108	225	1781	723

- Speed**  
up to 2.5 m/s
- Acceleration**  
up to 20 m/s<sup>2</sup>
- Travel length**  
up to 120 m
- Additional load**  
up to 6 kg/m

The gliding cable carrier must be guided in a channel. See p. 844.

The GO module mounted on the driver is a defined sequence of 5 adapted KR/RKR link plates.

Glide shoes must be used for gliding applications.

Only designs 020 and 030 can be used for a gliding arrangement.

Subject to change without notice.

Cable carrier
Cable carrier configuration
Configuration guidelines
Materials information
MONO series
QuickTrax® series
UNIFLEX Advanced series
TKP35 series
TKK series
EasyTrax® series

## Stay variant 020 – closed frame

- » Weight-optimised, closed plastic frame with particularly high torsional rigidity.
- » **Outside/inside:** not openable.



Stay arrangement on each chain link (**VS: fully-stayed**)



$B_i$ : 25 – 130 mm

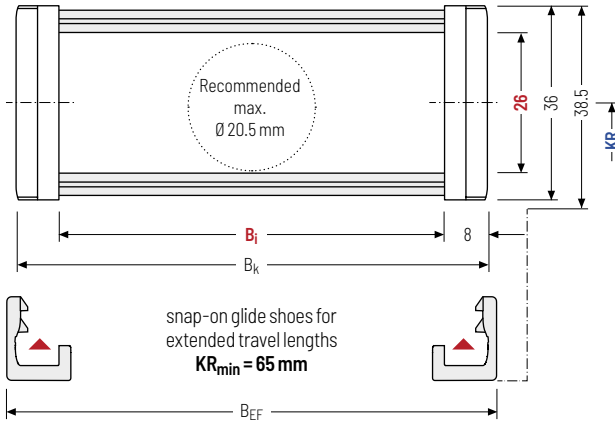

The maximum cable diameter strongly depends on the bending radius and the desired cable type. Please contact us.

### Calculating the cable carrier length

#### Cable carrier length $L_k$

$$L_k \approx \frac{L_S}{2} + L_B$$

Cable carrier length  $L_k$  rounded to pitch  $t$



### Special version for support legs of commercial vehicles

Special versions for the safe guiding and separating of rigid hydraulic hoses and electric cables in a limited space in extendable support feet of commercial vehicles on request.

$h_i$ [mm]	$h_G$ [mm]	$h_G'$ [mm]	$B_i$ [mm]			$B_k$ [mm]	$B_{EF}$ [mm]	$KR$ [mm]				$q_k$ [kg/m]
26	36	38.5	25	38	58	$B_i + 16$	$B_i + 19$	52	65	95	125	0.71 - 1.12
			78	103	130			150	180	200		

### Order example



UA1455

Type

020

Stay variant

78

$B_i$  [mm]

150

$KR$  [mm]

1456

$L_k$  [mm]

VS

Stay arrangement

## Stay variant 030 – with outside opening and detachable stays

- » Weight-optimised plastic frame with particularly high torsional rigidity.
- » Swivable and detachable left or right in any position.
- » **Outside:** openable and detachable.



Stay arrangement on each chain link (VS: fully-stayed)



$B_i$ : 25 – 130 mm

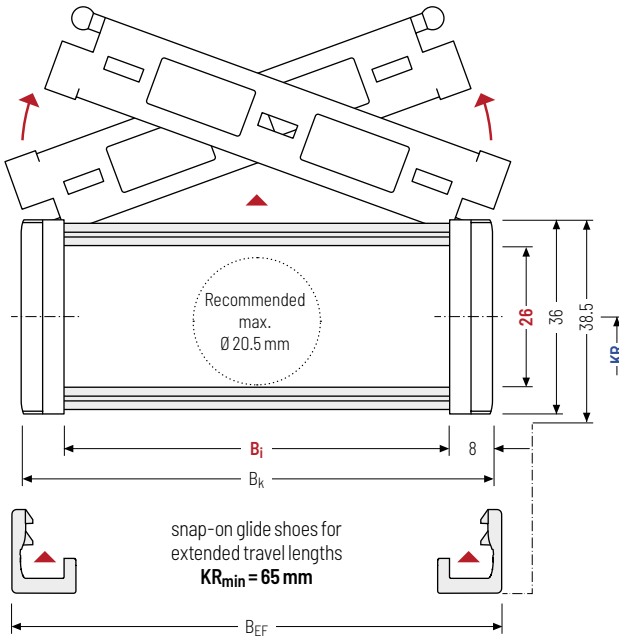

**i** The maximum cable diameter strongly depends on the bending radius and the desired cable type. Please contact us.

### Calculating the cable carrier length

**Cable carrier length  $L_k$**

$$L_k \approx \frac{L_S}{2} + L_B$$

Cable carrier length  $L_k$  rounded to pitch  $t$

$h_i$ [mm]	$h_G$ [mm]	$h_{G'}$ [mm]	$B_i$ [mm]			$B_k$ [mm]	$B_{EF}$ [mm]	KR [mm]				$q_k$ [kg/m]
26	36	38.5	25	38	58	$B_i + 16$	$B_i + 19$	52	65	95	125	0.73 – 1.10
			78	103	130			150	180	200		

### Order example

UA1455
030
78
150
1456
VS

Type · Stay variant ·  $B_i$  [mm] · KR [mm] ·  $L_k$  [mm] · Stay arrangement

### Stay variant 040 – with inside opening and detachable stays

- » Weight-optimised plastic frame with particularly high torsional rigidity.
- » Swivable and detachable left or right in any position.
- » **Inside:** openable and detachable.



Stay arrangement on each chain link (**VS: fully-stayed**)



$B_i$ : 25 – 130 mm

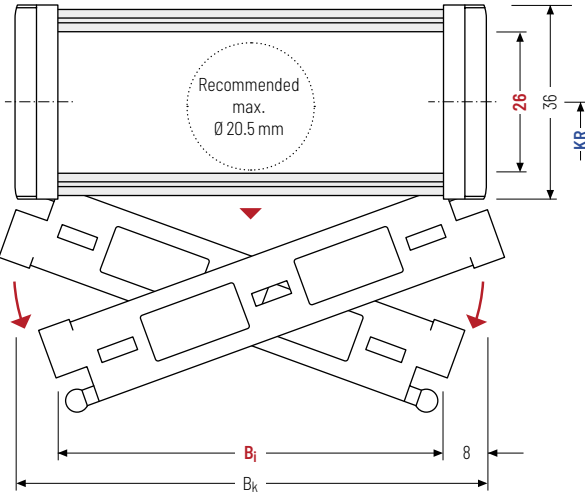

The maximum cable diameter strongly depends on the bending radius and the desired cable type. Please contact us.

Design 040 is not suitable for gliding arrangements.

#### Calculating the cable carrier length

**Cable carrier length  $L_k$**

$$L_k \approx \frac{L_S}{2} + L_B$$

Cable carrier length  $L_k$  rounded to pitch  $t$

$h_i$ [mm]	$h_g$ [mm]	$B_i$ [mm]			$B_k$ [mm]	$KR$ [mm]				$q_k$ [kg/m]
26	36	25	38	58	$B_i + 16$	52	65	95	125	0.73 – 1.10
		78	103	130		150	180	200		

#### Order example

UA1455 Type · 
 040 Stay variant · 
 78  $B_i$  [mm] · 
 150  $KR$  [mm] · 
 1456  $L_k$  [mm] · 
 VS Stay arrangement

## Divider systems

The divider system is mounted on every 2<sup>nd</sup> chain link as a standard.

As a standard, dividers or the complete divider system (dividers with height separations) are movable in the cross section (**version A**).

For applications with lateral acceleration and lying on the side, divider with arresting cams are available.

The locking cams click into place in the locking grids in the stays (**version B**).

### Divider system TSO without height separation

Vers.	a <sub>T</sub> min [mm]	a <sub>x</sub> min [mm]	a <sub>c</sub> min [mm]	a <sub>x</sub> grid [mm]	η <sub>T</sub> min
A	3.5	7	5	-	-
B*	4/5**	7.5	5.5	2.5	-

Number of dividers for design Q20 depending on B<sub>i</sub>  
 \* not for design Q20

\*\* 4 mm for B<sub>i</sub> 38 - 103; 5 mm for B<sub>i</sub> 25, 130

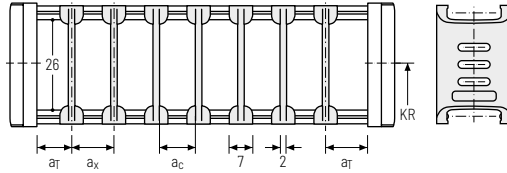

### Divider system TS1 with continuous height separation\*

Vers.	a <sub>T</sub> min [mm]	a <sub>T</sub> max [mm]	a <sub>x</sub> min [mm]	a <sub>c</sub> min [mm]	a <sub>x</sub> grid [mm]	η <sub>T</sub> min
A	3.5	20	7	5	-	2
B	4/5**	20	7.5	5.5	2.5	2

\* not for design Q20

\*\* 4 mm for B<sub>i</sub> 38 - 103; 5 mm for B<sub>i</sub> 25, 130

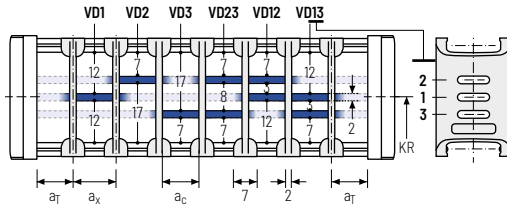

### Divider system TS3 with height separation consisting of plastic section subdivisions

Vers.	a <sub>T</sub> min [mm]	a <sub>x</sub> min [mm]	a <sub>c</sub> min [mm]	η <sub>T</sub> min
A	3.5	15	10	2

The dividers are fixed with the section subdivision. The entire divider system can be moved in the cross section.

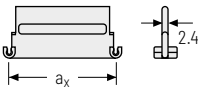
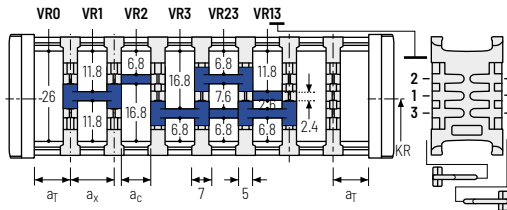

a <sub>x</sub> (centre distance of dividers) [mm]									
a <sub>c</sub> (usable width of inner chamber) [mm]									
15	20	25	30	35	40	45	55	65	75
10	15	20	25	30	35	40	50	60	70

### Order example

TS3

A

2

K1

34

VR1

⋮

⋮

⋮

K4

38

VR3

Divider system

Version

η<sub>T</sub>

Chamber

a<sub>x</sub>

Height separation



## Universal end connectors UMB – plastic (standard)

The universal mounting brackets (UMB) are made from plastic and can be mounted **from above, from below or on the face side**.

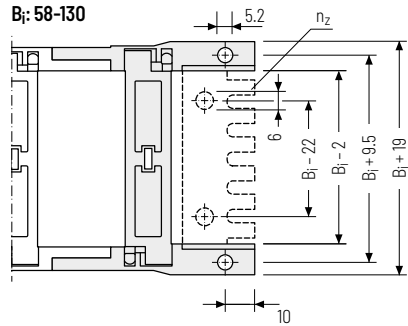
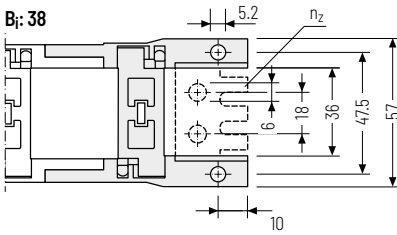
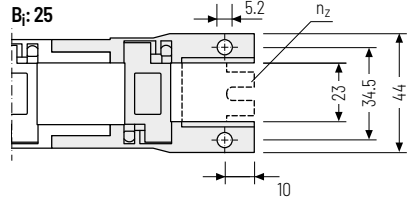
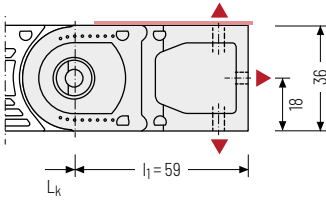

Recommended tightening torque:  
5 Nm for screws M5 - 8.8

Assembly options

$B_i$ [mm]	$n_z$
25	2
38	3
58	5
78	7
103	9
130	11

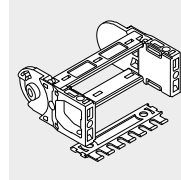

The end connectors are optionally also available **with strain relief comb** (1 on each side). Please state when ordering.

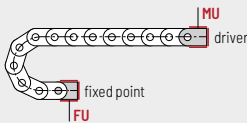

**Connection point**  
F – fixed point  
M – driver

**Connection type**  
U – Universal mounting bracket

### Order example

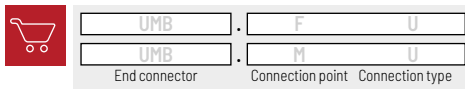

## Single-part end connectors short – plastic

The plastic end connectors can be connected **from above or below**. The connection type can be changed by altering the position of the end connector.

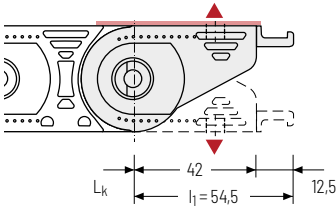

**B<sub>i</sub>: 25**

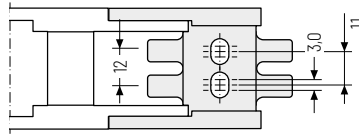

**B<sub>i</sub>: 38-130**

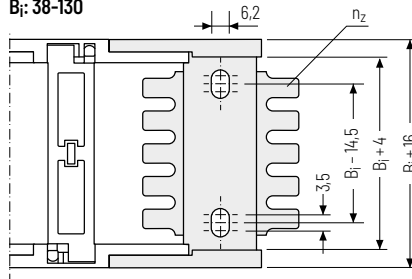

Recommended tightening torque:  
6 Nm for screws M6 – 8.8

B <sub>i</sub> [mm]	n <sub>z</sub>
25	2 x 2
38	2 x 3
58	2 x 4
78	2 x 6
103	2 x 8
130	2 x 10

### ▲ Assembly options

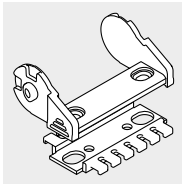

The end connectors are optionally also available **without** strain relief comb (except B<sub>i</sub> 25). Please state when ordering.

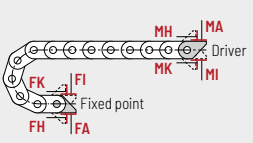

**Connection point**  
**F** – fixed point  
**M** – driver

**Connection type**  
**A** – threaded joint outside (standard)  
**I** – threaded joint inside  
**H** – threaded joint, rotated 90° to the outside  
**K** – threaded joint, rotated 90° to the inside

### Order example



End connector	.	F	A
End connector	.	M	A
End connector		Connection point	Connection type

Cable carrier
Cable carrier configuration
Configuration guidelines
Materials information
MONO series
QuickTrax® series
UNIFLEX Advanced series
TKP35 series
TKK series
EasyTrax® series

## Single-part end connectors long – plastic

The plastic end connectors can be connected **from above or below** and allow a **1:1 replacement of the UNIFLEX 0455 in the connection area**. The connection type can be changed by altering the position of the end connector.

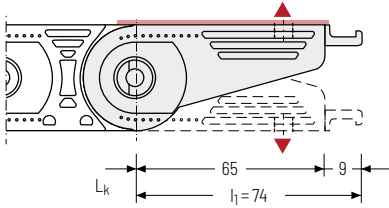

**B<sub>i</sub>: 25**

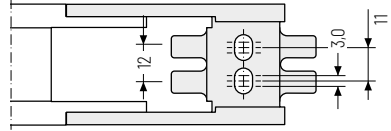

**B<sub>i</sub>: 38-130**

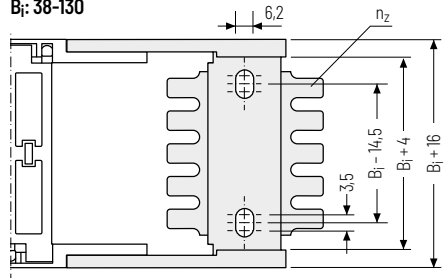

▲ Assembly options

 Recommended tightening torque:  
6 Nm for screws M6 - 8.8 and washers

B <sub>i</sub> [mm]	n <sub>2</sub>
25	2 x 2
38	2 x 3
58	2 x 4
78	2 x 6
103	2 x 8
130	2 x 10

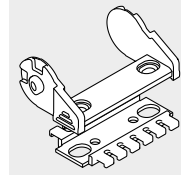

The end connectors are optionally also available **without strain relief comb** (except B<sub>i</sub> 25). Please state when ordering.

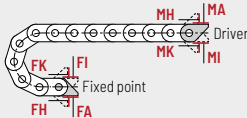

**Connection point**  
**F** – fixed point  
**M** – driver

**Connection type**  
**A** – threaded joint outside (standard)  
**I** – threaded joint inside  
**H** – threaded joint, rotated 90° to the outside  
**K** – threaded joint, rotated 90° to the inside

### Order example



End connector U0455	F	A
End connector U0455	M	A
End connector	Connection point	Connection type

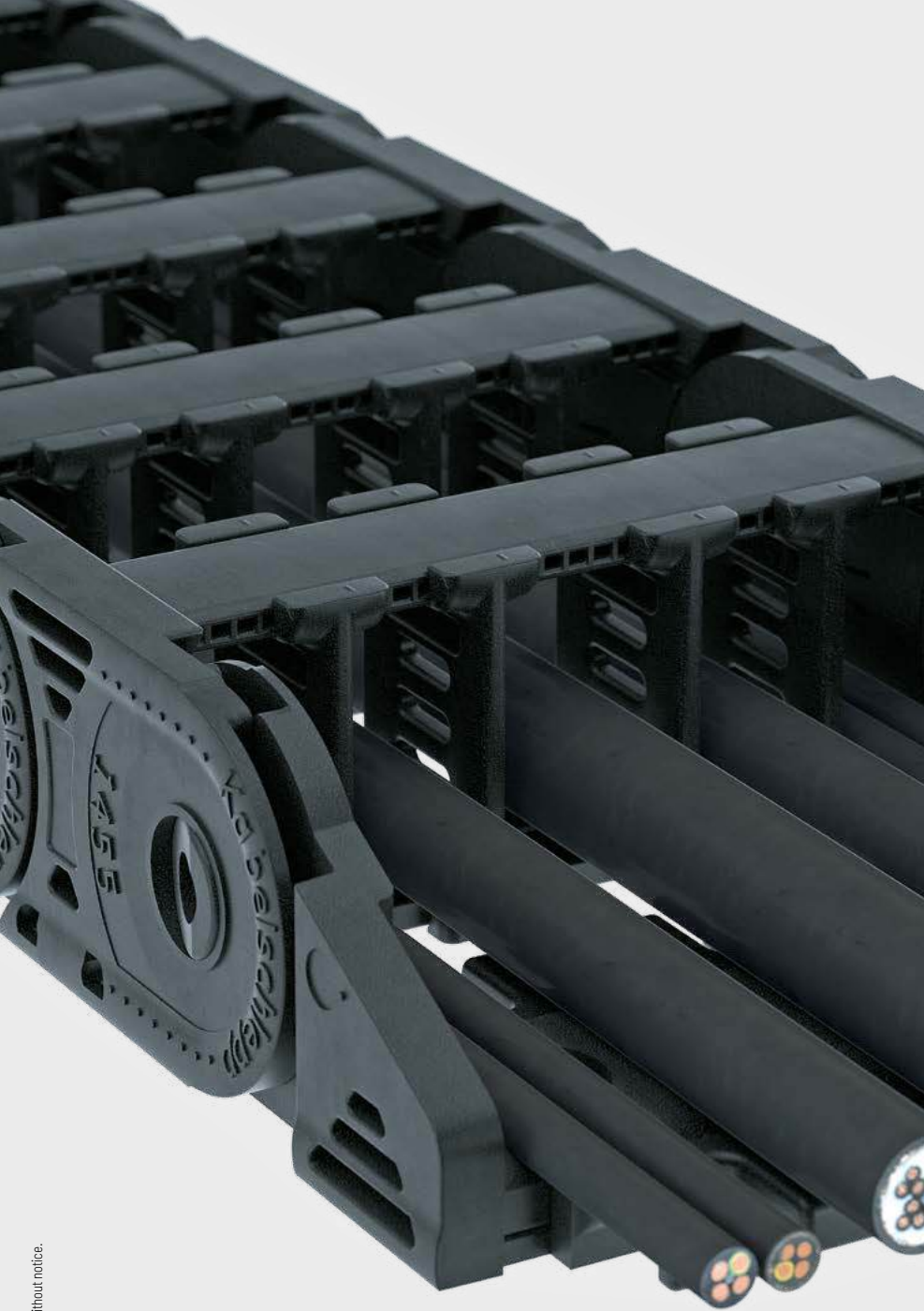

EasyTrax®  
series

TKK  
series

TKP35  
series

**UNIFLEX**  
Advanced  
series

QuickTrax®  
series

MONO  
series

Materials  
information

Configuration  
guidelines

Cable carrier  
configuration

Cable carrier

# UA1555



**Pitch**  
55.5 mm



**Inner height**  
38 mm



**Inner widths**  
50 – 150 mm



**Bending radii**  
63 – 200 mm

## Stay variants



**Design 020** ..... page 174

### Closed frame

- » Weight-optimised, closed plastic frame with particularly high torsional rigidity.
- » **Outside/inside:** not openable.



**Design 030** ..... page 175

### Frame with outside detachable stays

- » Weight-optimised plastic frame with particularly high torsional rigidity.
- » **Outside:** openable and detachable.



**Design 040** ..... page 176

### Frame with inside detachable stays

- » Weight-optimised plastic frame with particularly high torsional rigidity.
- » **Inside:** openable and detachable.

## Additional product information online



Installation instructions, etc.:  
Additional info via your smartphone or  
check online at  
[tsubaki-kabelschlepp.com/  
downloads](https://www.tsubaki-kabelschlepp.com/downloads)



Configure your cable carrier here:  
[online-engineer.de](https://www.online-engineer.de)

Unsupported arrangement

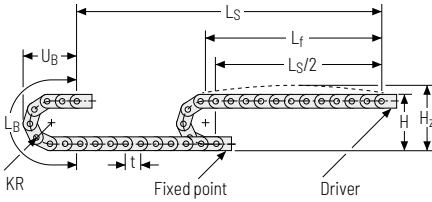

KR [mm]	H [mm]	H <sub>z</sub> [mm]	L <sub>B</sub> [mm]	U <sub>B</sub> [mm]
63	176	216	309	145
80	210	240	362	165
100	250	280	425	185
125	300	330	504	210
160	370	400	614	245
200	450	480	740	285

Load diagram for unsupported length depending on the additional load.

Sagging of the cable carrier is technically permitted for extended travel lengths, depending on the specific application.

Intrinsic cable carrier weight  $q_k = 1.32 \text{ kg/m}$  with  $B_i 100 \text{ mm}$ . For other inner widths, the maximum additional load changes.

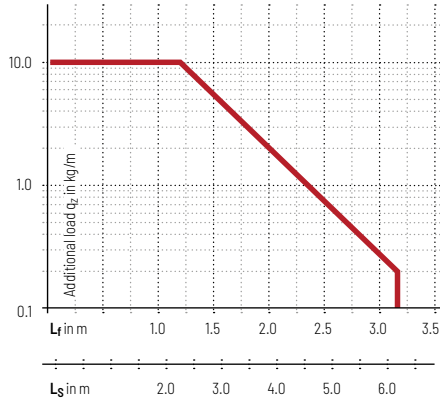

**Speed**  
up to 9 m/s

**Acceleration**  
up to  $45 \text{ m/s}^2$

**Travel length**  
up to 6.3 m

**Additional load**  
up to 10 kg/m

Gliding arrangement | GO module with chain links optimized for gliding

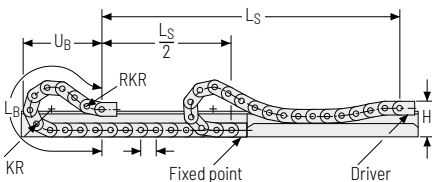

KR [mm]	H [mm]	GO-Modul RKR [mm]	L <sub>B</sub> [mm]	U <sub>B</sub> [mm]
63	150	250	939	458
80	150	250	994	473
100	150	250	1105	510
125	150	250	1272	567
160	150	250	1438	612
200	150	250	1771	730

**Speed**  
up to 3 m/s

**Acceleration**  
up to  $20 \text{ m/s}^2$

**Travel length**  
up to 125 m

**Additional load**  
up to 10 kg/m

The gliding cable carrier must be guided in a channel. See p. 844.

The GO module mounted on the driver is a defined sequence of 5 adapted KR/RKR link plates.

Glide shoes must be used for gliding applications.

Only designs 020 and 030 can be used for a gliding arrangement.

## Stay variant 020 – closed frame

- » Weight-optimised, closed plastic frame with particularly high torsional rigidity.
- » **Outside/inside:** not openable.



Stay arrangement on each chain link (**VS: fully-stayed**)



$B_i$ : 50 - 150 mm

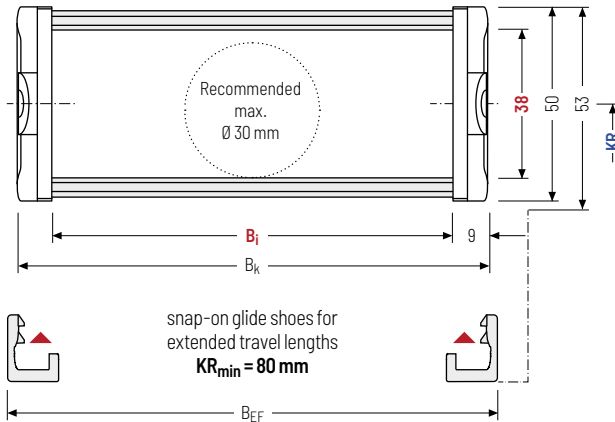

The maximum cable diameter strongly depends on the bending radius and the desired cable type. Please contact us.

### Calculating the cable carrier length

Cable carrier length  $L_k$

$$L_k \approx \frac{L_S}{2} + L_B$$

Cable carrier length  $L_k$   
rounded to pitch  $t$

$h_i$ [mm]	$h_G$ [mm]	$h_G'$ [mm]	$B_i$ [mm]			$B_k$ [mm]	$B_{EF}$ [mm]	KR [mm]				$q_k$ [kg/m]
38	50	53	50	75	100	$B_i + 18$	$B_i + 22$	63	80	100	125	1.13 - 1.52
			125	150	160			200				

### Order example



UA1555

Type

020

Stay variant

125

$B_i$  [mm]

160

KR [mm]

1887

$L_k$  [mm]

VS

Stay arrangement

**Stay variant 030** – with outside opening and detachable stays

- » Weight-optimised plastic frame with particularly high torsional rigidity.
- » Swivable and detachable left or right in any position.
- » **Outside:** openable and detachable.

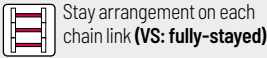

Stay arrangement on each chain link (VS: fully-stayed)



$B_i$ : 50 – 150 mm

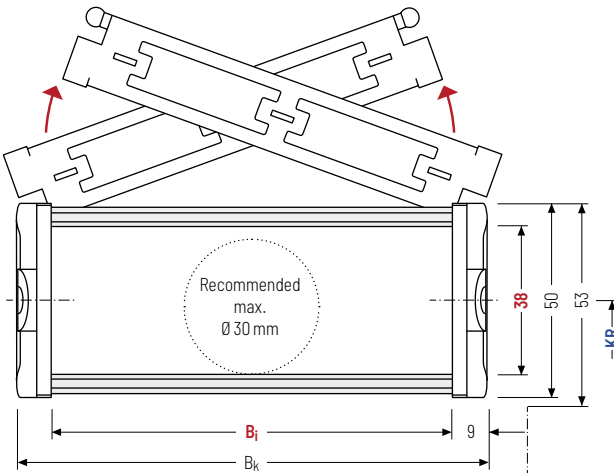

**i** The maximum cable diameter strongly depends on the bending radius and the desired cable type. Please contact us.

**Calculating the cable carrier length**

**Cable carrier length  $L_k$**

$$L_k \approx \frac{L_S}{2} + L_B$$

Cable carrier length  $L_k$  rounded to pitch  $t$



$h_i$ [mm]	$h_G$ [mm]	$h_{G'}$ [mm]	$B_i$ [mm]			$B_k$ [mm]	$B_{EF}$ [mm]	$KR$ [mm]				$q_k$ [kg/m]
38	50	53	50	75	100	$B_i + 18$	$B_i + 22$	63	80	100	125	1.13 – 1.51
			125	150	160			200				

**Order example**

UA1555 · 
 030 · 
 125 · 
 160 · 
 1887 · 
 VS  
 Type      Stay variant       $B_i$  [mm]       $KR$  [mm]       $L_k$  [mm]      Stay arrangement

Cable carrier
Cable carrier configuration
Configuration guidelines
Materials information
MONO series
QuickTrax® series
UNIFLEX Advanced series
TKP35 series
TKK series
EasyTrax® series



## Stay variant 040 – with inside opening and detachable stays

- » Weight-optimised plastic frame with particularly high torsional rigidity.
- » Swivable and detachable left or right in any position.
- » **Inside:** openable and detachable.



Stay arrangement on each chain link (**VS: fully-stayed**)



$B_i$ : 50 - 150 mm

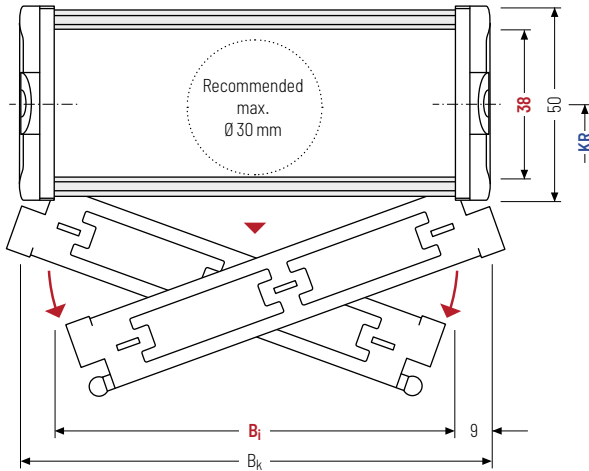

The maximum cable diameter strongly depends on the bending radius and the desired cable type. Please contact us.



Design 040 is not suitable for gliding arrangements.

### Calculating the cable carrier length

#### Cable carrier length $L_k$

$$L_k \approx \frac{L_S}{2} + L_B$$

Cable carrier length  $L_k$  rounded to pitch  $t$

$h_i$ [mm]	$h_g$ [mm]	$h_g'$ [mm]	$B_i$ [mm]			$B_k$ [mm]	$KR$ [mm]				$q_k$ [kg/m]
38	50	53	50	75	100	$B_i + 18$	63	80	100	125	1.13 - 1.52
			125	150			160	200			

### Order example



UA1555

Type

040

Stay variant

125

$B_i$  [mm]

160

$KR$  [mm]

1887

$L_k$  [mm]

VS

Stay arrangement

**Divider systems**

The divider system is mounted on every 2<sup>nd</sup> chain link as a standard.

For applications with lateral acceleration and lying on the side, divider with arresting cams are available.

As a standard, dividers or the complete divider system (dividers with height separations) are movable in the cross section (**version A**).

The locking cams click into place in the locking grids in the stays (**version B**).

**Divider system TSO without height separation**

Vers.	a <sub>T</sub> min [mm]	a <sub>x</sub> min [mm]	a <sub>c</sub> min [mm]	a <sub>x</sub> grid [mm]	n <sub>T</sub> min
A	5	10	7.5	-	-
B*	5	10	7.5	2.5	-

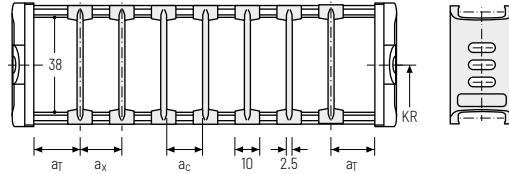

Number of dividers for design Q20 depending on B<sub>i</sub>  
 \* not for design Q20

**Divider system TS1 with continuous height separation\***

Vers.	a <sub>T</sub> min [mm]	a <sub>T</sub> max [mm]	a <sub>x</sub> min [mm]	a <sub>c</sub> min [mm]	a <sub>x</sub> grid [mm]	n <sub>T</sub> min
A	5	20	10	7.5	-	2
B	5	20.5	10	7.5	2.5	2

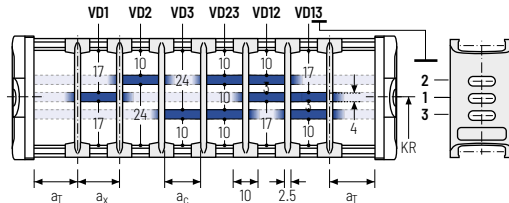

\* not for design Q20

**Divider system TS3 with height separation consisting of plastic section subdivisions**

Vers.	a <sub>T</sub> min [mm]	a <sub>x</sub> min [mm]	a <sub>c</sub> min [mm]	n <sub>T</sub> min
A	5	15	10	2

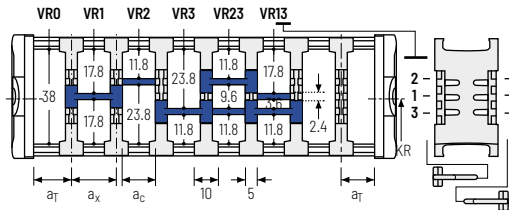

\* not for design Q20

The dividers are fixed with the partitions. The entire divider system can be moved in the cross section.

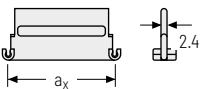

a <sub>x</sub> (centre distance of dividers) [mm]									
a <sub>c</sub> (usable width of inner chamber) [mm]									
15	20	25	30	35	40	45	55	65	75
10	15	20	25	30	35	40	50	60	70

**Order example**

TS3 · 
 A · 
 2 · 
 K1 · 
 34 - 
 VR1  
 ⋮ ⋮ ⋮  
 · K4 · 38 - VR3

Divider system      Version      n<sub>T</sub>      Chamber      a<sub>x</sub>      Height separation

Cable carrier  
 Cable carrier configuration  
 Configuration guidelines  
 Materials information  
 MONO series  
 QuickTrax® series  
 UNIFLEX Advanced series  
 TKP35 series  
 TKK series  
 EasyTrax® series

## Universal end connectors UMB – plastic (standard)

The universal mounting brackets (UMB) are made from plastic and can be mounted **from above, from below or on the face side**.

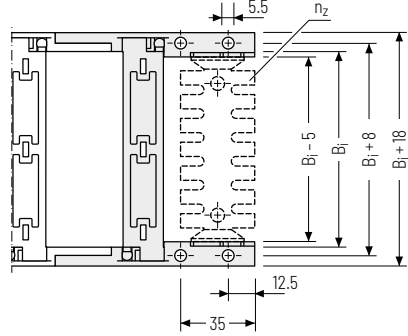
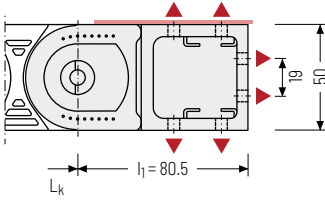

▲ Assembly options

 Recommended tightening torque:  
5 Nm for screws M5 - 8.8

$B_1$ [mm]	$n_z$
50	2 x 3
75	2 x 5
90	2 x 6
100	2 x 7
125	2 x 9
150	2 x 11

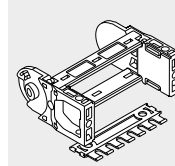

The end connectors are optionally also available **with** strain relief comb or **with** C-rail Art. no. 3931 (1 on each side) for clamps. Please state when ordering.

UNIFLEX  
Advanced  
series

TKP35  
series

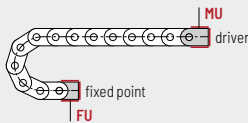



**Connection point**  
F – fixed point  
M – driver

**Connection type**  
U – Universal mounting bracket

TKK  
series

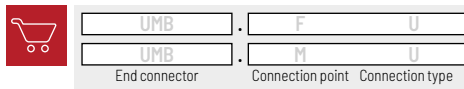
### Order example



 We recommend the use of strain reliefs at the driver and fixed point. See from p. 904.

EasyTrax®  
series

Single-part end connectors short – plastic

The plastic end connectors can be **connected from above or below**. The connection type can be changed by altering the position of the end connector.

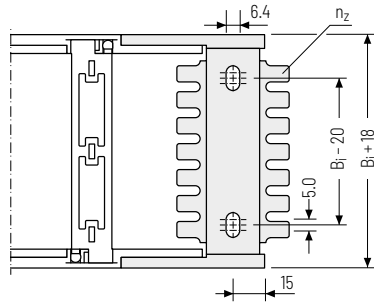
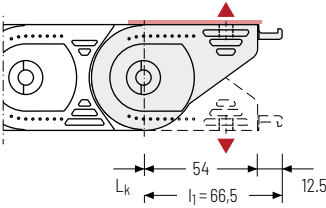

▲ Assembly options

Recommended tightening torque:  
6 Nm for screws M6 - 8.8

$B_i$ [mm]	$n_z$
50	2 x 4
75	2 x 6
100	2 x 8
125	2 x 10
150	2 x 12

The end connectors are optionally also available **without** strain relief comb. Please state when ordering.

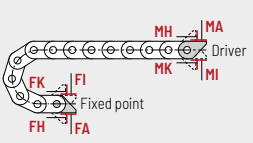

**Connection point**  
**F** - fixed point  
**M** - driver

**Connection type**  
**A** - threaded joint outside (standard)  
**I** - threaded joint inside  
**H** - threaded joint, rotated 90° to the outside  
**K** - threaded joint, rotated 90° to the inside

Order example

End connector	.	F	A
End connector	.	M	A
End connector		Connection point	Connection type

Cable carrier
Cable carrier configuration
Configuration guidelines
Materials information
MONO series
QuickTrax® series
<b>UNIFLEX</b> Advanced series
TKP35 series
TKK series
EasyTrax® series

## Single-part end connectors long – plastic

The plastic end connectors can be connected **from above or below** and allow a **1:1 replacement of the UNIFLEX 0555 in the connection area**. The connection type can be changed by altering the position of the end connector.

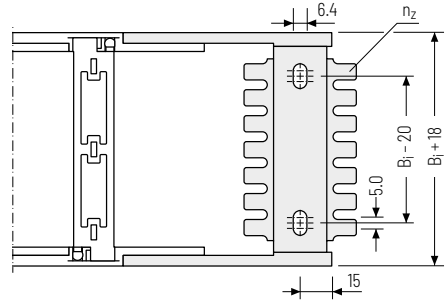
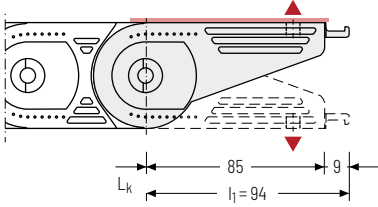

### ▲ Assembly options



Recommended tightening torque:  
6 Nm for screws M6 - 8.8 and washers

$B_1$ [mm]	$n_z$
50	2 x 4
75	2 x 6
100	2 x 8
125	2 x 10
150	2 x 12

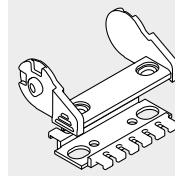

The end connectors are optionally also available **without** strain relief comb.  
Please state when ordering.

UNIFLEX  
Advanced  
series

TKP35  
series

TKK  
series

EasyTrax®  
series

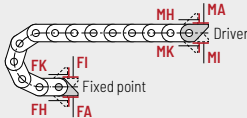

### Connection point

F – fixed point  
M – driver

### Connection type

A – threaded joint outside (standard)  
I – threaded joint inside  
H – threaded joint, rotated 90° to the outside  
K – threaded joint, rotated 90° to the inside

### Order example



End connector U0555

F A

End connector U0555

M A

End connector

Connection point Connection type



Subject to change without notice.

EasyTrax®  
series

TKK  
series

TKP35  
series

**UNIFLEX**  
Advanced  
series

QuickTrax®  
series

MONO  
series

Materials  
information

Configuration  
guidelines

Cable carrier  
configuration

Cable carrier

# UA1665

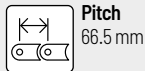

**Pitch**  
66.5 mm



**Inner height**  
44 mm



**Inner widths**  
50 – 250 mm

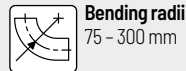

**Bending radii**  
75 – 300 mm

## Stay variants



**Design 020** ..... page 184

### Closed frame

- » Weight-optimised, closed plastic frame with particularly high torsional rigidity.
- » **Outside/inside:** not openable.



**Design 030** ..... page 185

### Frame with outside detachable stays

- » Weight-optimised plastic frame with particularly high torsional rigidity.
- » **Outside:** openable and detachable.



**Design 040** ..... page 186

### Frame with inside detachable stays

- » Weight-optimised plastic frame with particularly high torsional rigidity.
- » **Inside:** openable and detachable.

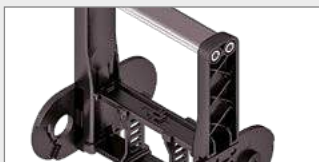

**Design RMA** ..... page 188

### Mounting frame stay

- » Weight-optimised plastic frame with particularly high torsional rigidity.
- » **Outside/inside:** threaded joint easy to release.

Unsupported arrangement

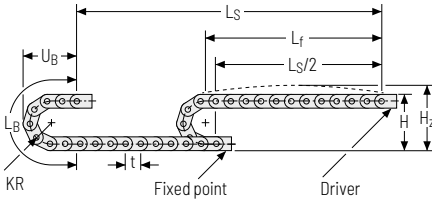





KR [mm]	H [mm]	H <sub>z</sub> [mm]	L <sub>B</sub> [mm]	U <sub>B</sub> [mm]
75	210	245	369	172
100	260	295	448	197
120	300	335	511	217
140	340	375	574	237
200	460	495	762	297
250	560	595	919	347
300	660	695	1076	397

Load diagram for unsupported length depending on the additional load.

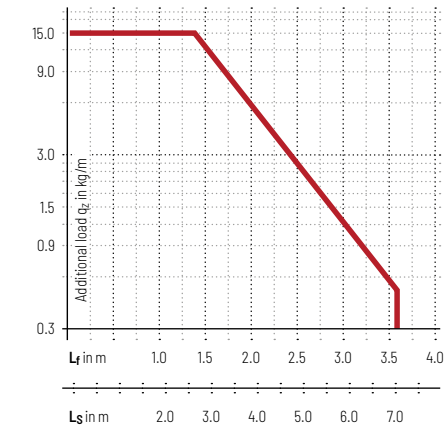
Sagging of the cable carrier is technically permitted for extended travel lengths, depending on the specific application.

Intrinsic cable carrier weight  $q_k = 2.43 \text{ kg/m}$  with  $B_3$  200 mm. For other inner widths, the maximum additional load changes.





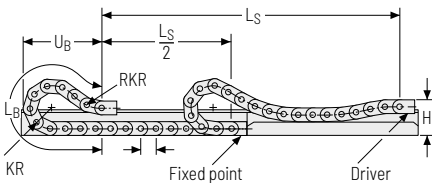

-  **Speed**  
up to 8 m/s
-  **Acceleration**  
up to 40 m/s<sup>2</sup>
-  **Travel length**  
up to 7 m
-  **Additional load**  
up to 15 kg/m

Gliding arrangement | GO module with chain links optimized for gliding



KR [mm]	H [mm]	GO-Modul RKR [mm]	L <sub>B</sub> [mm]	U <sub>B</sub> [mm]
75	180	300	1118	546
100	180	300	1251	593
120	180	300	1318	609
140	180	300	1450	654
200	180	300	1783	753
250	180	300	2182	864
300	180	300	2581	1035

-  **Speed**  
up to 3 m/s
-  **Acceleration**  
up to 15 m/s<sup>2</sup>
-  **Travel length**  
up to 150 m
-  **Additional load**  
up to 15 kg/m

 The gliding cable carrier must be guided in a channel. See p. 844.

The GO module mounted on the driver is a defined sequence of 5 adapted KR/RKR link plates.

Glide shoes must be used for gliding applications.

Only designs 020 and 030 can be used for a gliding arrangement.

Cable carrier

Cable carrier configuration

Configuration guidelines

Materials information

MONO series

QuickTrax® series

UNIFLEX Advanced series

TKP35 series

TKK series

EasyTrax® series



### Stay variant 020 – closed frame

- » Weight-optimised, closed plastic frame with particularly high torsional rigidity.
- » **Outside/inside:** not openable.



Stay arrangement on each chain link (**VS: fully-stayed**)



B: 50 - 250 mm

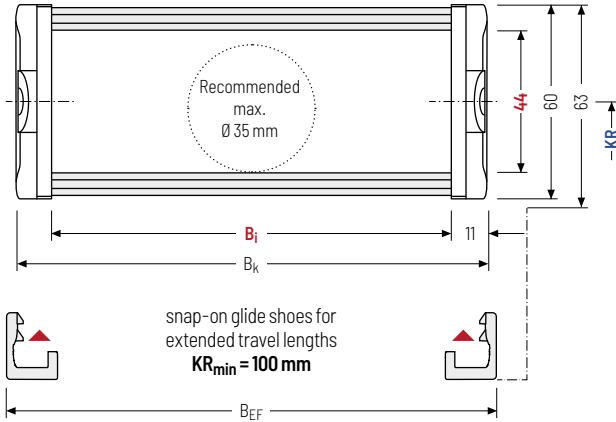

The maximum cable diameter strongly depends on the bending radius and the desired cable type. Please contact us.

#### Calculating the cable carrier length

Cable carrier length  $L_k$

$$L_k \approx \frac{L_S}{2} + L_B$$

Cable carrier length  $L_k$  rounded to pitch  $t$

UNIFLEX Advanced series

TKP35 series

TKK series

EasyTrax® series

$h_i$ [mm]	$h_g$ [mm]	$h_g'$ [mm]	$B_i$ [mm]					$B_k$ [mm]	$B_{EF}$ [mm]	$KR$ [mm]				$q_k$ [kg/m]
44	60	63	50	75	100	125	150	$B_i + 22$	$B_i + 27$	75	100	120	140	1.67 - 2.76
			175	200	225	250			200	250	300			

#### Order example

UA1665
Type
·
020
Stay variant
·
125
B<sub>i</sub> [mm]
·
140
KR [mm]
·
2660
L<sub>k</sub> [mm]
·
VS
Stay arrangement

**Stay variant 030** – with outside opening and detachable stays

- » Weight-optimised plastic frame with particularly high torsional rigidity.
- » Swivable and detachable left or right in any position.
- » **Outside:** openable and detachable.



Stay arrangement on each chain link (**VS: fully-stayed**)

$B_i$  50 – 250 mm

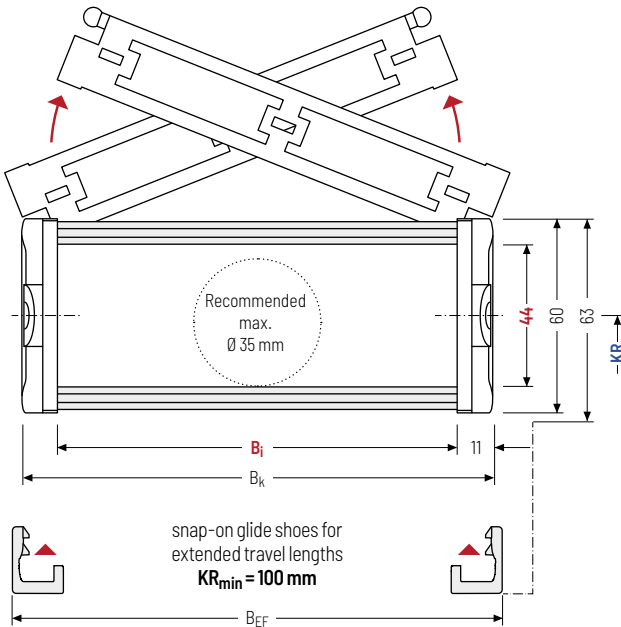

The maximum cable diameter strongly depends on the bending radius and the desired cable type. Please contact us.

**Calculating the cable carrier length**

**Cable carrier length  $L_k$**

$$L_k \approx \frac{L_S}{2} + L_B$$

Cable carrier length  $L_k$  rounded to pitch  $t$

$h_i$ [mm]	$h_g$ [mm]	$h_g'$ [mm]	$B_i$ [mm]					$B_k$ [mm]	$B_{EF}$ [mm]	$KR$ [mm]				$q_k$ [kg/m]
44	60	63	50	75	100	125	150	$B_i + 22$	$B_i + 27$	75	100	120	140	1.67 – 2.70
			175	200	225	250			200	250	300			

**Order example**

UA1665 · 
 030 · 
 125 · 
 140 · 
 2660 · 
 VS  
 Type      Stay variant       $B_i$  [mm]       $KR$  [mm]       $L_k$  [mm]      Stay arrangement

Cable carrier
Cable carrier configuration
Configuration guidelines
Materials information
MONO series
QuickTrax® series
<b>UNIFLEX Advanced series</b>
TKP35 series
TKK series
EasyTrax® series

## Stay variant 040 – with inside opening and detachable stays

- » Weight-optimised plastic frame with particularly high torsional rigidity.
- » Swivable and detachable left or right in any position.
- » **Inside:** openable and detachable.





Stay arrangement on each chain link (**VS: fully-stayed**)

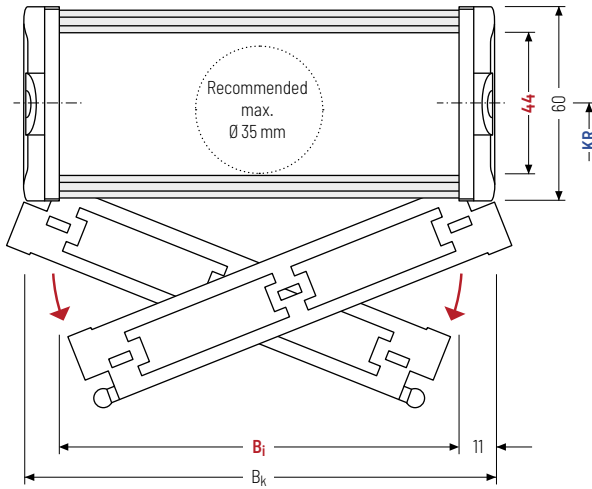

$B_i$ : 50 - 250 mm



 The maximum cable diameter strongly depends on the bending radius and the desired cable type. Please contact us.

 Design 040 is not suitable for gliding arrangements.

### Calculating the cable carrier length

#### Cable carrier length $L_k$

$$L_k \approx \frac{L_S}{2} + L_B$$

Cable carrier length  $L_k$  rounded to pitch  $t$

$h_i$ [mm]	$h_G$ [mm]	$B_i$ [mm]					$B_k$ [mm]	$KR$ [mm]				$q_k$ [kg/m]
44	60	50	75	100	125	150	$B_i + 22$	75	100	120	140	1.67 - 2.70
		175	200	225	250			200	250	300		

### Order example



UA1665

Type

040

Stay variant

125

$B_i$  [mm]

140

$KR$  [mm]

2660

$L_k$  [mm]

VS

Stay arrangement

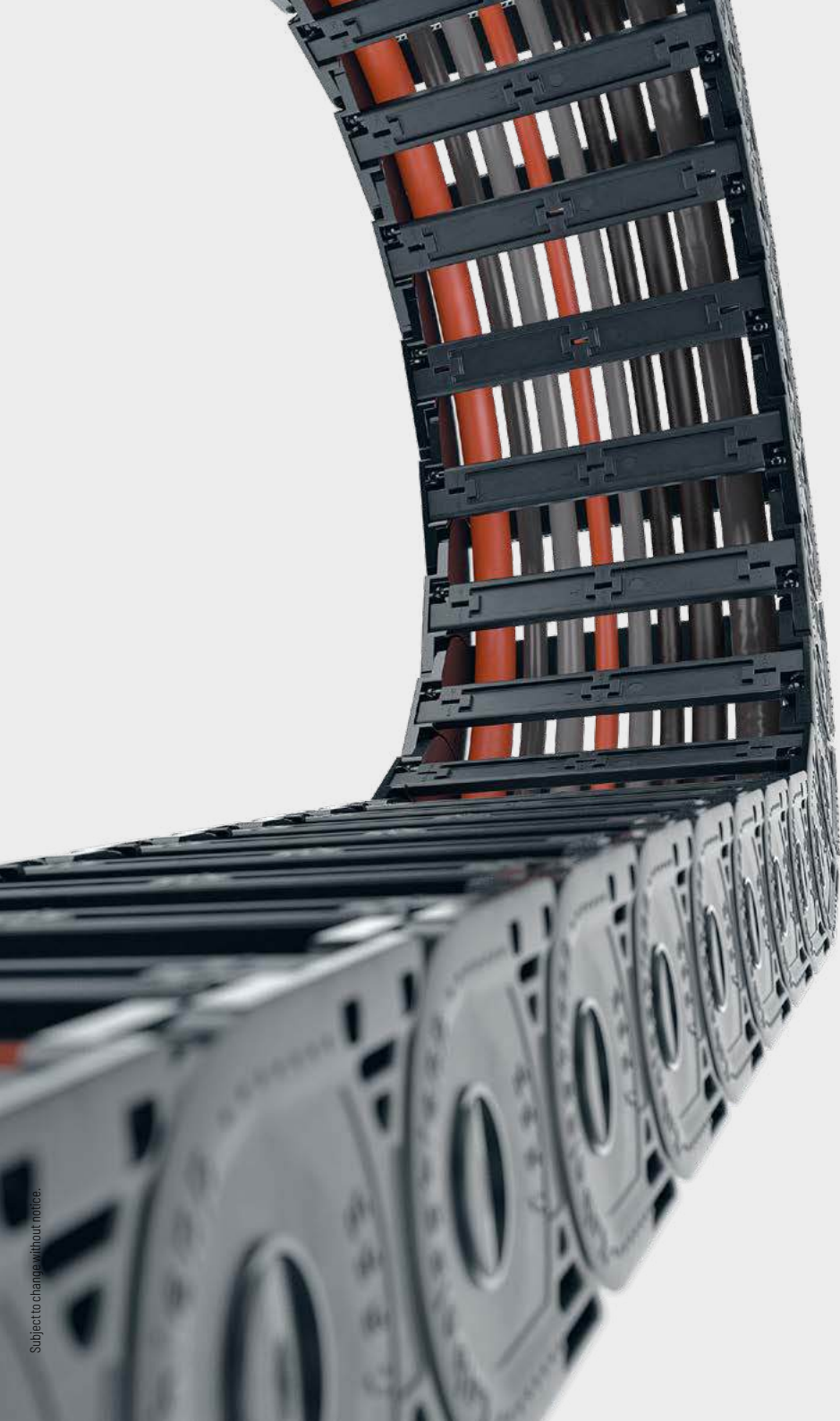

EasyTrax®  
series

TKK  
series

TKP35  
series

**UNIFLEX**  
Advanced  
series

QuickTrax®  
series

MONO  
series

Materials  
information

Configuration  
guidelines

Cable carrier  
configuration

Cable carrier

## Stay variant RMA - mounting frame stay

- » Weight-optimized plastic frame with particularly high torsional rigidity.
- » Plastic stays and aluminum profile bars with plastic mounting frame stays for guiding very large cable diameters.
- » **Outside/inside:** threaded joint easy to release.

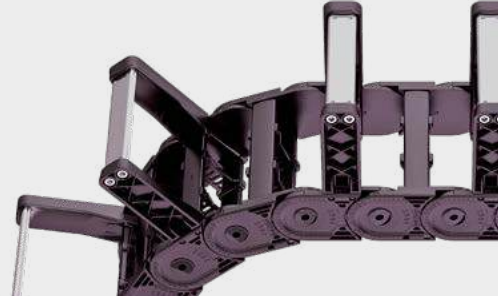

Stay arrangement on each chain link (**VS: fully-stayed**)



$B_i$  125 - 200 mm

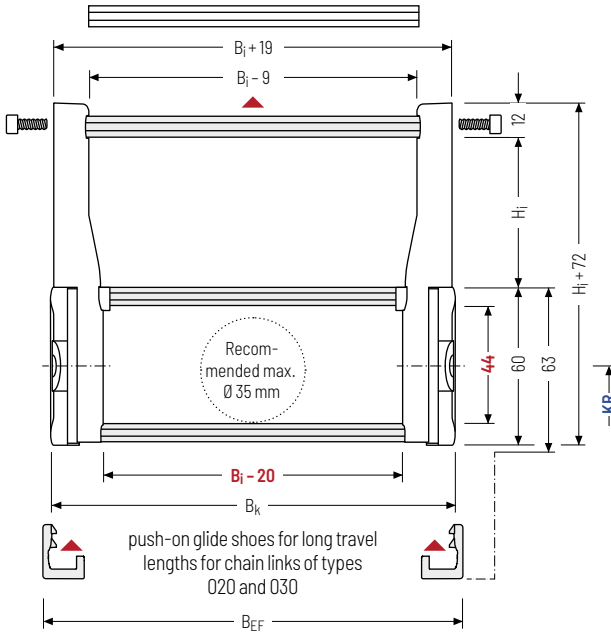

The maximum cable diameter strongly depends on the bending radius and the desired cable type. Please contact us.

### Calculating the cable carrier length

#### Cable carrier length $L_k$

$$L_k \approx \frac{L_S}{2} + L_B$$

Cable carrier length  $L_k$  rounded to pitch  $t$

UNIFLEX  
Advanced  
series

TKP35  
series

TKK  
series

EasyTrax®  
series

$h_i$ [mm]	$h_g$ [mm]	$H_i$ [mm]	$B_i$ [mm]	$B_k$ [mm]	$B_{EF}$ [mm]	$KR$ [mm]				$q_k$ (RMAI)* [kg/m]	$q_k$ (RMAO)* [kg/m]
44	60	114 139 164 189	125 150 175 200	$B_i + 22$	$B_i + 27$	75 200	100 250	120 300	140	3.10 - 3.95	3.58 - 4.66

\* indicated according to standard pitch

### Order example



UA1665

Type

030

Stay variant

150

$B_i$  [mm]

140

$KR$  [mm]

2660

$L_k$  [mm]

RMAO

Stay arrangement

## Assembly variants

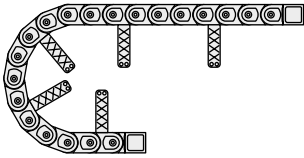

### RMAI – assembly to the inside:

standard pitch, mounting frame stay on every 4<sup>th</sup> stay, no screw fixing.

Gliding application is not possible when using assembly version RMAI.

Observe minimum KR:

H<sub>i</sub> = 114 mm: KR<sub>min</sub> = 200 mm

H<sub>i</sub> = 139 mm: KR<sub>min</sub> = 250 mm

H<sub>i</sub> = 164 mm: KR<sub>min</sub> = 300 mm

H<sub>i</sub> = 189 mm: KR<sub>min</sub> = 300 mm

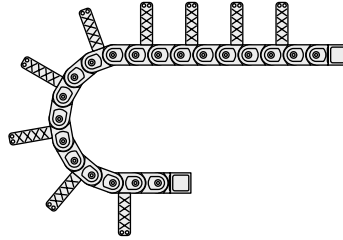

### RMAO – assembly to the outside:

standard pitch, mounting frame stay on every 2<sup>nd</sup> stay, screw fixing.

The cable carrier rests on the bars. A bracket must be provided for the fixed point.

Guiding in a **channel is required** for support. Please contact our technical support at [technik@kabelschlepp.de](mailto:technik@kabelschlepp.de) to find the corresponding guide channel.

Please note the operating and installation height.

## Cross section mounting frame stay

To achieve a nearly square cross section in the mounting frame stay, we recommend the following combination of B<sub>i</sub> and H<sub>i</sub>:

B <sub>i</sub> [mm]	H <sub>i</sub> [mm]	KR <sub>min</sub> [mm]	Stays [mm]
125	114	200	100
150	139	250	125
175	164	300	150
200	189	300	175

Cable carrier

Cable carrier configuration

Configuration guidelines

Materials information

MONO series

QuickTrax® series

UNIFLEX Advanced series

TKP35 series

TKK series

EasyTrax® series



### TOTALTRAX® complete systems

Benefit from the advantages of the TOTALTRAX® complete system. A complete delivery from one source – with a warranty certificate on request! Learn more at [tsubaki-kabelschlepp.com/totaltrax](http://tsubaki-kabelschlepp.com/totaltrax)



### TRAXLINE® cables for cable carriers

Hi-flex electric cables which were specially developed, optimised and tested for use in cable carriers can be found at [tsubaki-kabelschlepp.com/traxline](http://tsubaki-kabelschlepp.com/traxline).

EasyTrax®  
seriesTKK  
seriesTKP35  
seriesUNIFLEX  
Advanced  
seriesQuickTrax®  
seriesMONO  
seriesMaterials  
informationConfiguration  
guidelinesCable carrier  
configuration

Cable carrier



## Divider systems

The divider system is mounted on every 2<sup>nd</sup> chain link as a standard.

For applications with lateral acceleration and lying on the side, divider with arresting cams are available.

As a standard, dividers or the complete divider system (dividers with height separations) are movable in the cross section (**version A**).

The locking cams click into place in the locking grids in the stays (**version B**).

### Divider system TSO without height separation

Vers.	a <sub>T</sub> min [mm]	a <sub>x</sub> min [mm]	a <sub>c</sub> min [mm]	a <sub>x</sub> grid [mm]	η <sub>T</sub> min
A	5	10	7	-	-
B*	5	10	7	2.5	-

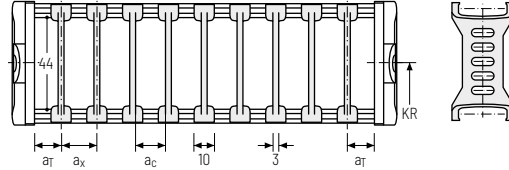

Number of dividers for design Q20 depending on B<sub>i</sub>  
\* not for design Q20

### Divider system TS1 with continuous height separation\*

Vers.	a <sub>T</sub> min [mm]	a <sub>T</sub> max [mm]	a <sub>x</sub> min [mm]	a <sub>c</sub> min [mm]	a <sub>x</sub> grid [mm]	η <sub>T</sub> min
A	5	20	10	7	-	2
B	5	20	10	7	2.5	2

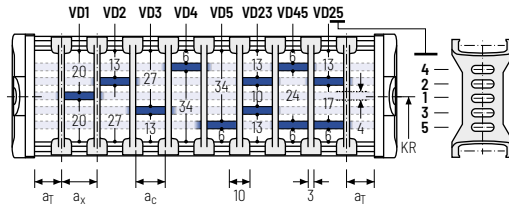

\* not for design Q20

### Divider system TS3 with height separation consisting of plastic section subdivisions

Vers.	a <sub>T</sub> min [mm]	a <sub>x</sub> min [mm]	a <sub>c</sub> min [mm]	η <sub>T</sub> min
A	4	16/40*	8	2

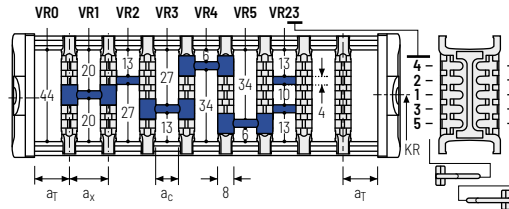

\* for aluminium partitions

The dividers are fixed with the partitions. The entire divider system can be moved in the cross section.

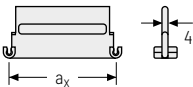

Aluminium partitions in 1 mm increments with a<sub>x</sub> > 42 mm are also available.

a <sub>x</sub> (centre distance of dividers) [mm]											
a <sub>c</sub> (usable width of inner chamber) [mm]											
16	18	23	28	32	33	38	43	48	58	64	68
8	10	15	20	24	25	30	35	40	50	56	60
78	80	88	96	112	128	144	160	176	192	208	
70	72	80	88	104	120	136	152	168	184	200	

When using partitions with a<sub>x</sub> > 112 mm, we recommend an additional central support with a **twin divider**. The height separations VD4 and VD5 are not possible when using twin dividers.

Cable carrier

Cable carrier configuration

Configuration guidelines

Materials information

MONO series

QuickTrax® series

UNIFLEX Advanced series

TKP35 series

TKK series

EasyTrax® series



## Universal end connectors UMB – plastic (standard)

The universal mounting brackets (UMB) are made from plastic and can be mounted **from above, from below or on the face side**.

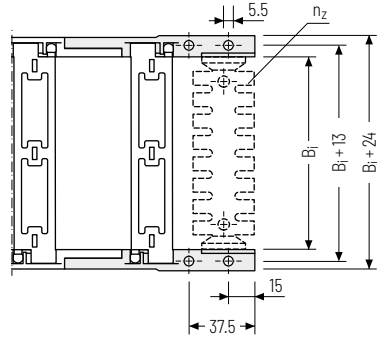
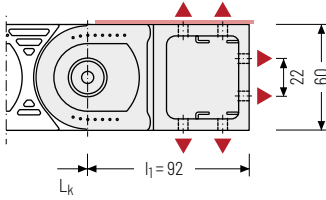

▲ Assembly options

 Recommended tightening torque:  
5 Nm for screws M5 - 8.8

$B_1$ [mm]	$n_2$
50	2 x 3
75	2 x 5
100	2 x 7
125	2 x 9
150	2 x 11
175	2 x 13

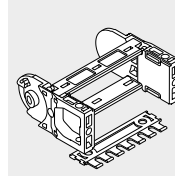

The end connectors are also available as an option **with** strain relief comb or **with** C-rail Art. no 3931 (1 on each side) for clamps. Please state when ordering.

UNIFLEX  
Advanced  
series

TKP35  
series

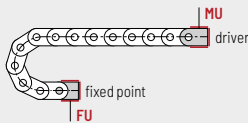



**Connection point**  
F – fixed point  
M – driver

**Connection type**  
U – Universal mounting bracket

TKK  
series

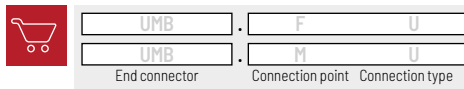
### Order example



 We recommend the use of strain reliefs at the driver and fixed point. See from p. 904.

EasyTrax®  
series

## Single-part end connectors – plastic

The plastic end connectors can be connected **from above or below**. The connection type can be changed by altering the position of the end connector.

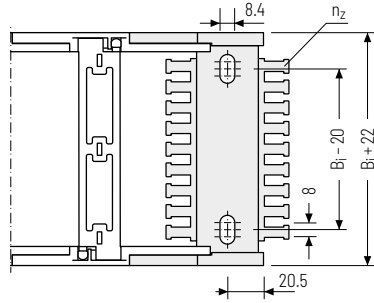
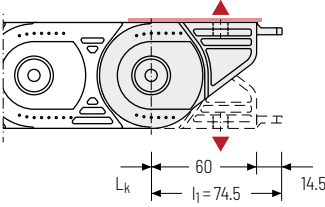

### ▲ Assembly options

**i** Recommended tightening torque:  
15 Nm for screws M8 - 8.8

$B_i$ [mm]	$n_z$
50	2 x 4
75	2 x 6
100	2 x 8
125	2 x 10
150	2 x 12
175	2 x 14
200	2 x 16
225	2 x 18
250	2 x 20

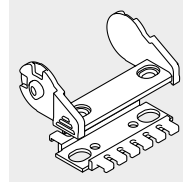

The end connectors are optionally also available **without** strain relief comb. Please state when ordering.

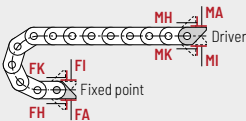

### Connection point

**F** - fixed point  
**M** - driver

### Connection type

**A** - threaded joint outside (standard)  
**I** - threaded joint inside  
**H** - threaded joint, rotated 90° to the outside  
**K** - threaded joint, rotated 90° to the inside

### Order example

 End connector . End connector . Connection point . Connection type

End connector . End connector . Connection point . Connection type

Cable carrier

Cable carrier configuration

Configuration guidelines

Materials information

MONO series

QuickTrax® series

UNIFLEX Advanced series

TKP35 series

TKK series

EasyTrax® series

# UA1775



**Pitch**  
77.5 mm



**Inner height**  
56 mm



**Inner widths**  
100 - 400 mm



**Bending radii**  
90 - 340 mm

## Stay variants



**Design 020** ..... page **196**

### Closed frame

- » Weight-optimised, closed plastic frame with particularly high torsional rigidity.
- » **Outside/inside:** not openable.



**Design 030** ..... page **197**

### Frame with outside detachable stays

- » Weight-optimised plastic frame with particularly high torsional rigidity.
- » **Outside:** openable and detachable.



**Design 040** ..... page **198**

### Frame with inside detachable stays

- » Weight-optimised plastic frame with particularly high torsional rigidity.
- » **Inside:** openable and detachable.

Unsupported arrangement

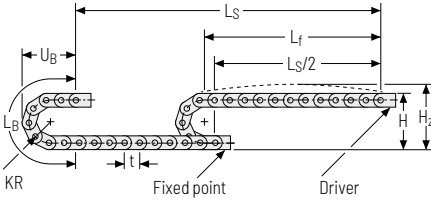





KR [mm]	H [mm]	H <sub>z</sub> [mm]	L <sub>B</sub> [mm]	U <sub>B</sub> [mm]
90	257	297	438	206
115	307	347	516	231
140	357	397	595	256
165	407	447	673	281
190	457	497	752	306
240	557	597	909	356
285	647	687	1050	401
340	757	797	1223	456

Load diagram for unsupported length depending on the additional load.

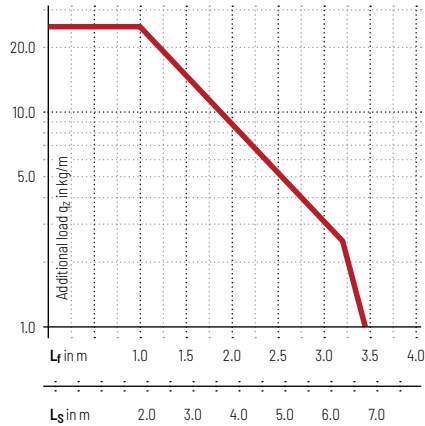
Sagging of the cable carrier is technically permitted for extended travel lengths, depending on the specific application.

Intrinsic cable carrier weight  $q_k = 3.03 \text{ kg/m}$  with  $B_i$  150 mm. For other inner widths, the maximum additional load changes.





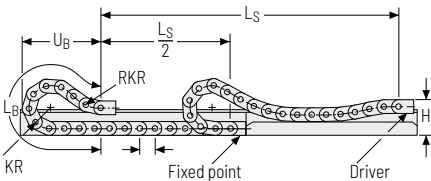

-  **Speed**  
up to 10 m/s
-  **Acceleration**  
up to  $35 \text{ m/s}^2$
-  **Travel length**  
up to 7.8 m
-  **Additional load**  
up to  $25 \text{ kg/m}$

Gliding arrangement | GO module with chain links optimized for gliding



KR [mm]	H [mm]	GO-Modul RKR [mm]	L <sub>B</sub> [mm]	U <sub>B</sub> [mm]
90	231	400	1313	643
115	231	400	1440	688
140	231	400	1575	733
165	231	400	1715	779
190	231	400	1868	828
240	231	400	2225	951
285	231	400	2580	1081
340	231	400	3015	1240

-  **Speed**  
up to 3 m/s
-  **Acceleration**  
up to  $8 \text{ m/s}^2$
-  **Travel length**  
up to 200 m
-  **Additional load**  
up to  $25 \text{ kg/m}$

 The gliding cable carrier must be guided in a channel. See p. 844.

The GO module mounted on the driver is a defined sequence of 5 adapted KR/RKR link plates.

Glide shoes must be used for gliding applications.

Cable carrier
Cable carrier configuration
Configuration guidelines
Materials information
MONO series
QuickTrax® series
UNIFLEX Advanced series
TKP35 series
TKK series
EasyTrax® series

## Stay variant 020 - closed frame

- » Weight-optimised, closed plastic frame with particularly high torsional rigidity.
- » **Outside/inside:** not openable.



Stay arrangement on each chain link (**VS: fully-stayed**)



$B_i$ : 100 - 400 mm

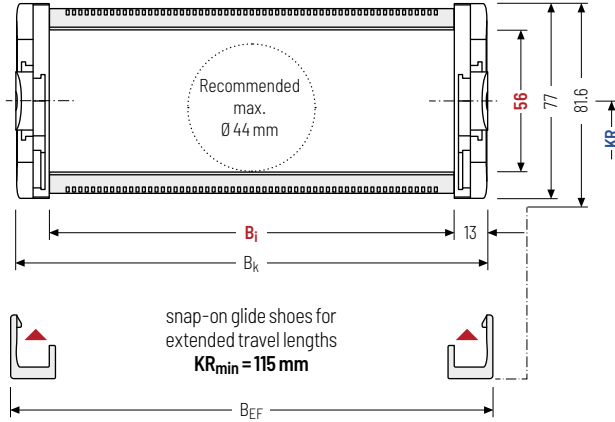

The maximum cable diameter strongly depends on the bending radius and the desired cable type. Please contact us.

### Calculating the cable carrier length

**Cable carrier length  $L_k$**

$$L_k \approx \frac{L_S}{2} + L_B$$

Cable carrier length  $L_k$  rounded to pitch  $t$

$h_i$ [mm]	$h_G$ [mm]	$h_G'$ [mm]	$B_i$ [mm]				$B_k$ [mm]	$B_{EF}$ [mm]	$KR$ [mm]			$q_k$ [kg/m]
56	77	81.6	100	125	150	175	$B_i + 26$	$B_i + 30$	90	115	140	2.844 - 4.239
			200	225	250	275			165	190	240	
			300	325	350	400			285	340		

### Order example

UA1775 Type · 
 020 Stay variant · 
 150  $B_i$  [mm] · 
 140  $KR$  [mm] · 
 3100  $L_k$  [mm] · 
 VS Stay arrangement

### Stay variant 030 – with outside opening and detachable stays

- » Weight-optimised plastic frame with particularly high torsional rigidity.
- » Swivable and detachable left or right in any position.
- » **Outside:** openable and detachable.



Stay arrangement on each chain link (**VS: fully-stayed**)

$B_i$  100 – 400 mm

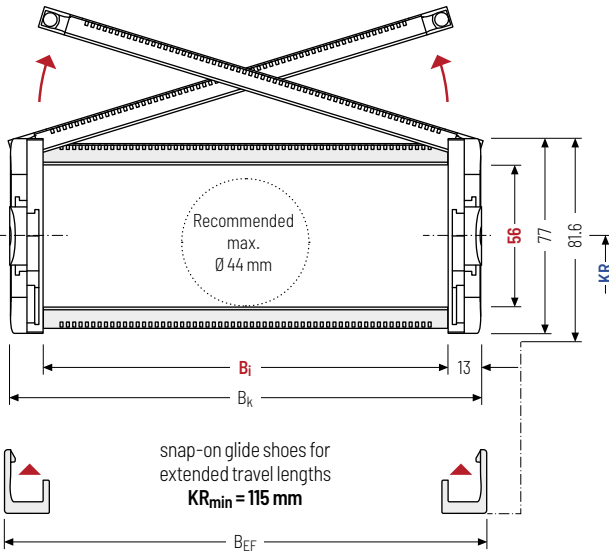

The maximum cable diameter strongly depends on the bending radius and the desired cable type. Please contact us.

#### Calculating the cable carrier length

**Cable carrier length  $L_k$**

$$L_k \approx \frac{L_S}{2} + L_B$$

Cable carrier length  $L_k$  rounded to pitch  $t$

$h_i$ [mm]	$h_G$ [mm]	$h_G'$ [mm]	$B_i$ [mm]				$B_k$ [mm]	$B_{EF}$ [mm]	$KR$ [mm]			$q_k$ [kg/m]
56	77	81.6	100	125	150	175	$B_i + 26$	$B_i + 30$	90	115	140	2.831 – 4.224
			200	225	250	275			165	190	240	
			300	325	350	400			285	340		

#### Order example

UA1775 · 
 030 · 
 150 · 
 140 · 
 3100 · 
 VS  
 Type      Stay variant       $B_i$  [mm]       $KR$  [mm]       $L_k$  [mm]      Stay arrangement

Cable carrier
Cable carrier configuration
Configuration guidelines
Materials information
MONO series
QuickTrax® series
UNIFLEX Advanced series
TKP35 series
TKK series
EasyTrax® series

## Stay variant 040 – with inside opening and detachable stays

- » Weight-optimised plastic frame with particularly high torsional rigidity.
- » Swivable and detachable left or right in any position.
- » **Inside:** openable and detachable.



Stay arrangement on each chain link (**VS: fully-stayed**)



$B_i$ : 100 - 400 mm

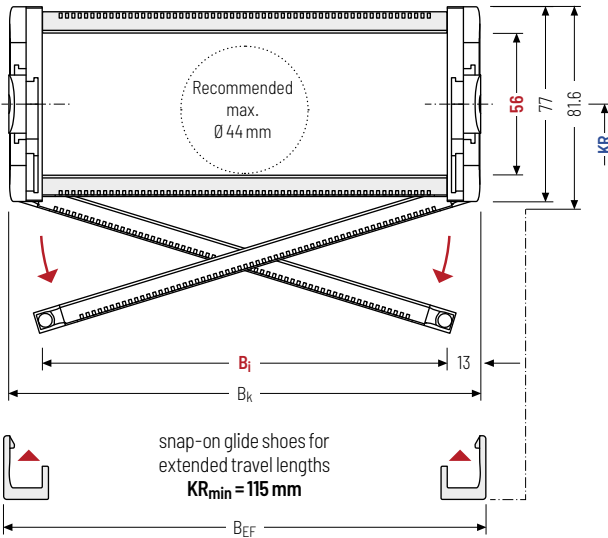

The maximum cable diameter strongly depends on the bending radius and the desired cable type. Please contact us.

Design 040 is not suitable for a gliding arrangements without the use of gliding shoes.

### Calculating the cable carrier length

#### Cable carrier length $L_k$

$$L_k \approx \frac{L_S}{2} + L_B$$

Cable carrier length  $L_k$  rounded to pitch  $t$

$h_i$ [mm]	$h_G$ [mm]	$h_G'$ [mm]	$B_i$ [mm]				$B_k$ [mm]	$B_{EF}$ [mm]	$KR$ [mm]			$q_k$ [kg/m]
56	77	81.6	100	125	150	175	$B_i + 26$	$B_i + 30$	90	115	140	2.831 - 4.224
			200	225	250	275			165	190	240	
			300	325	350	400			285	340		

### Order example



UA1775

Type

040

Stay variant

150

$B_i$  [mm]

140

$KR$  [mm]

3100

$L_k$  [mm]

VS

Stay arrangement

**Divider systems**

The divider system is mounted on every 2<sup>nd</sup> chain link as a standard.

For applications with lateral acceleration and lying on the side, divider with arresting cams are available.

As a standard, dividers or the complete divider system (dividers with height separations) are movable in the cross section (**version A**).

The locking cams click into place in the locking grids in the stays (**version B**).

**Divider system TSO without height separation**

Vers.	a <sub>T</sub> min [mm]	a <sub>x</sub> min [mm]	a <sub>c</sub> min [mm]	a <sub>x</sub> grid [mm]	n <sub>T</sub> min
A	5	10	7	-	-
B	5	10	7	2.5	-

Number of dividers for design Q20 depending on B<sub>i</sub>

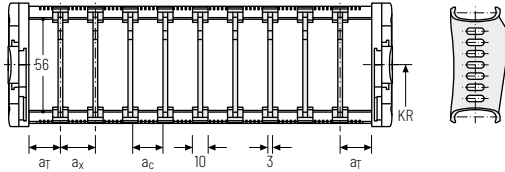

**Divider system TS1 with continuous height separation\***

Vers.	a <sub>T</sub> min [mm]	a <sub>x</sub> min [mm]	a <sub>c</sub> min [mm]	a <sub>x</sub> grid [mm]	n <sub>T</sub> min
A	5	10	7	-	2
B	5	10	7	2.5	2

\* not for design Q20

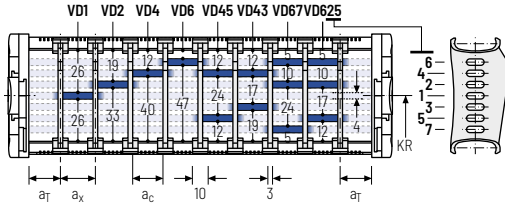

**Order example**

TS1

·

A

·

3

-

VD0

⋮

VD1

Divider system

Version

n<sub>T</sub>

Height separation

Please state the designation of the divider system (**TS0, TS1,...**), the version, and the number of dividers per cross section [n<sub>T</sub>].

When using divider systems with height separation (**TS1**), please additionally state the position (e.g. VD1) viewed from the left driver belt. You are welcome to add a sketch to your order.

	Cable carrier
	Cable carrier configuration
	Configuration guidelines
	Materials information
	MONO series
	QuickTrax® series
	UNIFLEX Advanced series
	TKP35 series
	TKK series
	EasyTrax® series



## Divider system TS3 with height separation consisting of plastic partitions

As a standard, the divider **version A** is used for vertical partitioning within the cable carrier. The complete divider system can be moved within the cross section.

Cable carrier

Cable carrier configuration

Configuration guidelines

Materials information

MONO series

QuickTrax® series

UNIFLEX Advanced series

TKP35 series

TKK series

EasyTrax® series

Divider version A

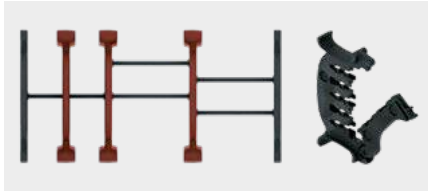

End divider

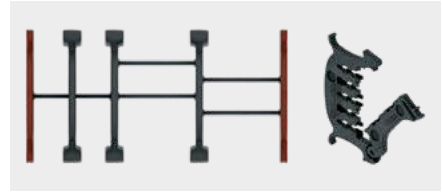

Vers.	$a_T$ min [mm]	$a_x$ min [mm]	$a_c$ min [mm]	$n_T$ min
A	5 / 2*	14	10	2

\* For End divider

The dividers are fixed by the partitions, the complete divider system is movable in the cross section.

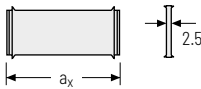
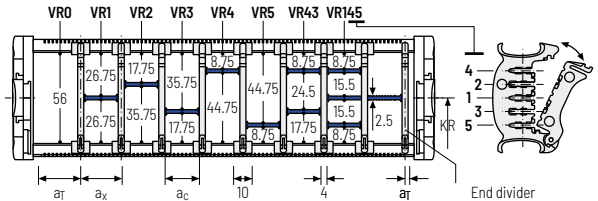

$a_x$ (center distance of dividers) [mm]																
$a_c$ (nominal width of inner chamber) [mm]																
14	16	19	23	24	28	29	32	33	34	38	39	43	44	48	49	54
10	12	15	19	20	24	25	28	29	30	34	35	39	40	44	45	50
58	59	64	68	69	74	78	79	80	84	88	89	94	96	99	112	
54	55	60	64	65	70	74	75	76	80	84	85	90	92	95	108	

When using **partitions with  $a_x > 49$  mm** we recommended an additional preferential central support.

### Order example

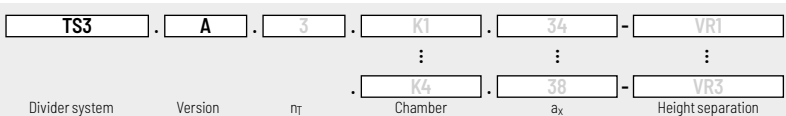

Please state the designation of the divider system (**TS0, TS1,...**), version and number of dividers per cross section [ $n_T$ ]. In addition, please also enter the chambers [K] from left to right, as well as the assembly distances [ $a_T/a_x$ ] (as seen from the driver).

If using divider systems with height separation (**TS1, TS3**) please also state the positions [e.g. VD23] viewed from the left driver belt. You are welcome to add a sketch to your order.

**Universal end connectors UMB – plastic (standard)**

The universal mounting brackets (UMB) are made from plastic and can be mounted **from above, from below or on the face side**.

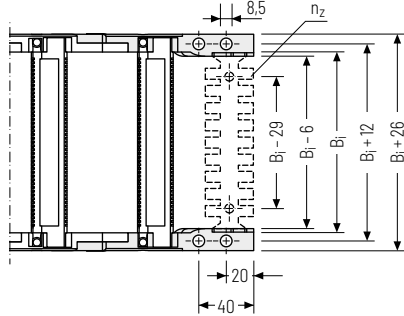
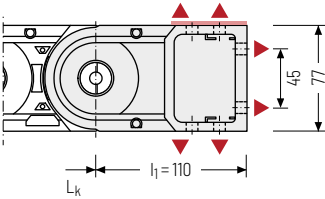

▲ Assembly options

**i** Recommended tightening torque:  
27 Nm for screws M8

<b>Bi</b> [mm]	<b>nz</b>
<b>100</b>	2 x 7
<b>125</b>	2 x 9
<b>150</b>	2 x 11
<b>175</b>	2 x 13

The end connectors are also available as an option **with** strain relief comb or **with** C-rail Art. no 3931 (1 on each side) for clamps. Please state when ordering.

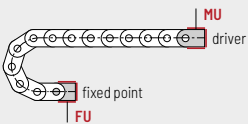

**Connection point**  
**F** - fixed point  
**M** - driver

**Connection type**  
**U** - Universal mounting bracket

**Order example**

	UMB	.	F	U
	UMB	.	M	U
	End connector		Connection point	Connection type

**i** We recommend the use of strain reliefs at the driver and fixed point. See from p. 904.

Cable carrier

Cable carrier configuration

Configuration guidelines

Materials information

MONO series

QuickTrax® series

**UNIFLEX**  
Advanced series

TKP35 series

TKK series

EasyTrax® series

# UA1995



**Pitch**  
99.5 mm



**Inner height**  
80 mm



**Inner widths**  
85 – 250 mm



**Bending radii**  
150 – 500 mm

## Stay variants



**Design 020** ..... page **204**

### Closed frame

- » Weight-optimised, closed plastic frame with particularly high torsional rigidity.
- » **Outside/inside:** not openable.



**Design 030** ..... page **205**

### Frame with outside detachable stays

- » Weight-optimised plastic frame with particularly high torsional rigidity.
- » **Outside:** release by rotating 90°.



**Design 040** ..... page **206**

### Frame with inside detachable stays

- » Weight-optimised plastic frame with particularly high torsional rigidity.
- » **Inside:** release by rotating 90°.



**Design 070** ..... page **207**

### Frame with outside and inside detachable stays

- » Weight-optimised plastic frame with particularly high torsional rigidity.
- » **Outside/inside:** release by rotating 90°.

Unsupported arrangement

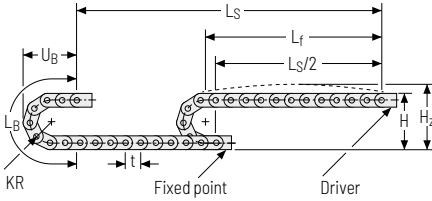

KR [mm]	H [mm]	H <sub>2</sub> [mm]	L <sub>B</sub> [mm]	U <sub>B</sub> [mm]
150	410	440	680	250
210	530	560	860	310
250	610	640	990	350
300	710	740	1150	400
350	810	840	1300	450
400	910	940	1460	500
500	1110	1140	1770	600

**Load diagram for unsupported length** depending on the additional load.

Sagging of the cable carrier is technically permitted for extended travel lengths, depending on the specific application.

Intrinsic cable carrier weight  $q_k = 3.85 \text{ kg/m}$  with  $B_i$  196 mm. For other inner widths, the maximum additional load changes.

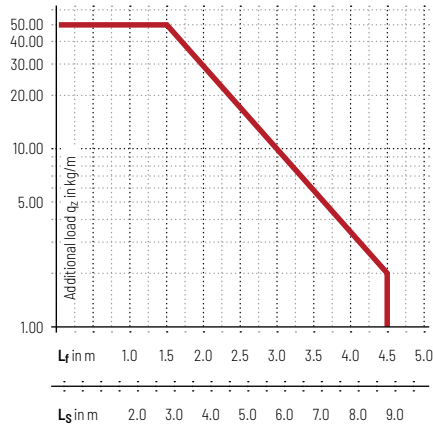

- Speed**  
up to 10 m/s
- Acceleration**  
up to 25 m/s<sup>2</sup>
- Travel length**  
up to 9 m
- Additional load**  
up to 50 kg/m

Gliding arrangement | GO module with chain links optimized for gliding\*

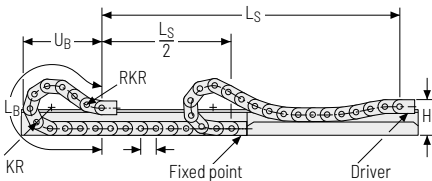

KR [mm]	H [mm]	GO-Modul RKR [mm]	L <sub>B</sub> [mm]	U <sub>B</sub> [mm]
150	330	400	1805	890
210	330	400	2180	1010
250	330	400	2390	1070
300	330	400	2690	1160
350	330	400	3090	1310
400	330	400	3490	1450
500	330	400	4280	1740

- Speed**  
up to 8 m/s
- Acceleration**  
up to 20 m/s<sup>2</sup>
- Travel length**  
up to 200 m
- Additional load**  
up to 50 kg/m

The gliding cable carrier must be guided in a channel. See p. 844.

The GO module mounted on the driver is a defined sequence of 5 adapted KR/RKR link plates.

Glide shoes must be used for gliding applications.

\* only design 070

Cable carrier

Cable carrier configuration

Configuration guidelines

Materials information

MONO series

QuickTrax® series

UNIFLEX Advanced series

TKP35 series

TKK series

EasyTrax® series

## Stay variant 020 – closed frame

- » Weight-optimised, closed plastic frame with particularly high torsional rigidity.
- » **Outside/inside:** not openable.



Stay arrangement on each chain link (**VS: fully-stayed**)



$B_i$ : 85 – 250 mm

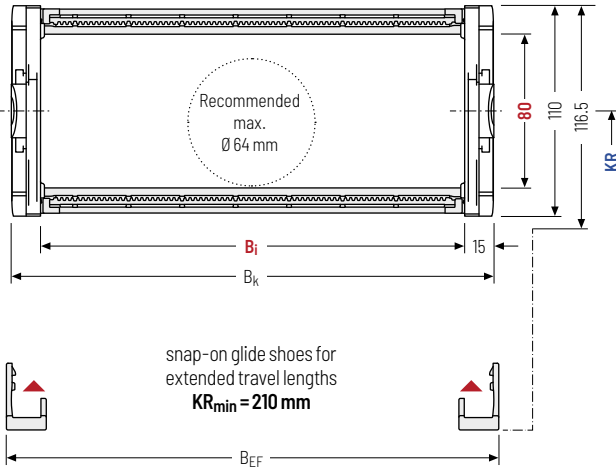

The maximum cable diameter strongly depends on the bending radius and the desired cable type. Please contact us.

### Calculating the cable carrier length

#### Cable carrier length $L_k$

$$L_k \approx \frac{L_S}{2} + L_B$$

Cable carrier length  $L_k$  rounded to pitch  $t$

$h_i$ [mm]	$h_g$ [mm]	$h_g'$ [mm]	$B_i$ [mm]				$B_k$ [mm]	$B_{EF}$ [mm]	$KR$ [mm]				$q_k$ [kg/m]
80	110	116.5	85	125	138	150	$B_i + 30$	$B_i + 36$	150	210	250	300	3.860 – 3.861
			180	196	225	250			350	400	500		

### Order example

UA1995
Type
·
020
Stay variant
·
150
 $B_i$  [mm]
·
210
 $KR$  [mm]
·
3582
 $L_k$  [mm]
·
VS
Stay arrangement

## Stay variant 030 – with outside detachable stays

- » Weight-optimised plastic frame with particularly high torsional rigidity.
- » **Outside:** release by rotating 90°.

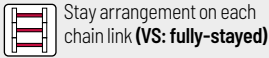

Stay arrangement on each chain link (VS: fully-stayed)



$B_1$ : 85 – 250 mm

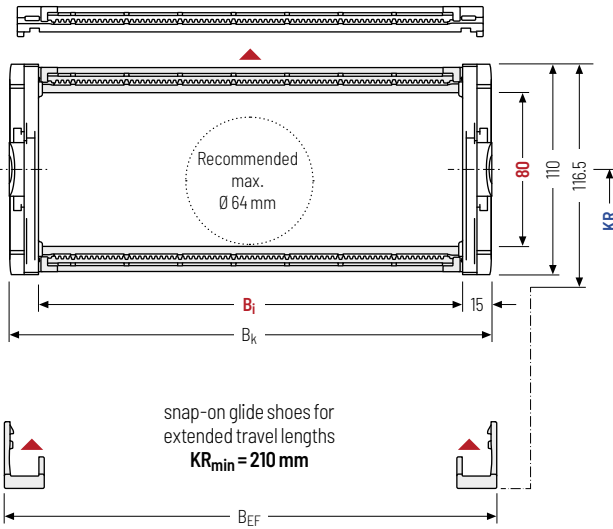

The maximum cable diameter strongly depends on the bending radius and the desired cable type. Please contact us.

### Calculating the cable carrier length

Cable carrier length  $L_k$

$$L_k \approx \frac{L_S}{2} + L_B$$

Cable carrier length  $L_k$  rounded to pitch  $t$

$h_1$ [mm]	$h_g$ [mm]	$h_{g'}$ [mm]	$B_1$ [mm]				$B_k$ [mm]	$B_{EF}$ [mm]	$KR$ [mm]				$q_k$ [kg/m]
80	110	116.5	85	125	138	150	$B_1 + 30$	$B_1 + 36$	150	210	250	300	3.833 – 3.834
			180	196	225	250			350	400	500		

### Order example

UA1995
Type
·
030
Stay variant
·
150
B<sub>1</sub> [mm]
·
210
KR [mm]
·
3582
L<sub>k</sub> [mm]
·
VS
Stay arrangement

## Stay variant 040 – with inside detachable stays

- » Weight-optimised plastic frame with particularly high torsional rigidity.
- » **Inside:** release by rotating 90°.



Stay arrangement on each chain link (**VS: fully-stayed**)



$B_i$ : 85 – 250 mm

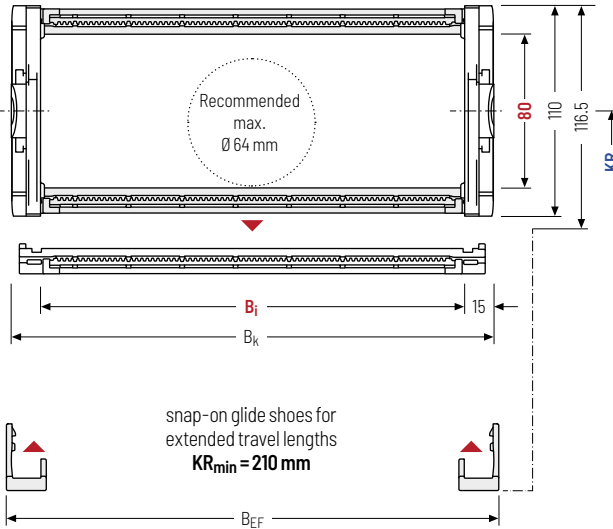

The maximum cable diameter strongly depends on the bending radius and the desired cable type. Please contact us.

Design 040 is not suitable for a gliding arrangements without the use of gliding shoes.

### Calculating the cable carrier length

#### Cable carrier length $L_k$

$$L_k \approx \frac{L_S}{2} + L_B$$

Cable carrier length  $L_k$  rounded to pitch  $t$

$h_i$ [mm]	$h_g$ [mm]	$h_g'$ [mm]	$B_i$ [mm]				$B_k$ [mm]	$B_{EF}$ [mm]	KR [mm]				$q_k$ [kg/m]
80	110	116.5	85	125	138	150	$B_i + 30$	$B_i + 36$	150	210	250	300	3.833 – 3.834
			180	196	225	250			350	400	500		

### Order example



UA1995

Type

040

Stay variant

150

$B_i$  [mm]

210

KR [mm]

3582

$L_k$  [mm]

VS

Stay arrangement

### Stay variant 070 – with outside and inside detachable stays

- » Weight-optimised plastic frame with particularly high torsional rigidity.
- » **Outside/Inside:** release by rotating 90°.



 Stay arrangement on each chain link (**VS: fully-stayed**)

  $B_i$  85 – 250 mm

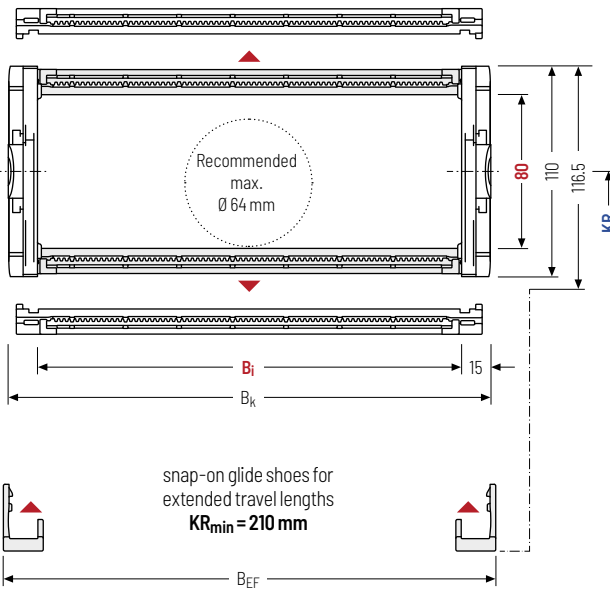

 The maximum cable diameter strongly depends on the bending radius and the desired cable type. Please contact us.

 Design 070 is not suitable for a gliding arrangements without the use of gliding shoes.

#### Calculating the cable carrier length

**Cable carrier length  $L_k$**

$$L_k \approx \frac{L_S}{2} + L_B$$

Cable carrier length  $L_k$  rounded to pitch  $t$

$h_i$ [mm]	$h_g$ [mm]	$h_g'$ [mm]	$B_i$ [mm]				$B_k$ [mm]	$B_{EF}$ [mm]	$KR$ [mm]				$q_k$ [kg/m]
80	110	116.5	85	125	138	150	$B_i + 30$	$B_i + 36$	150	210	250	300	3.852 – 3.853
			180	196	225	250			350	400	500		

#### Order example

 UA1995 . 070 . 150 . 210 . 3582 . VS  
 Type Stay variant  $B_i$  [mm] KR [mm]  $L_k$  [mm] Stay arrangement

- Cable carrier
- Cable carrier configuration
- Configuration guidelines
- Materials information
- MONO series
- QuickTrax® series
- UNIFLEX Advanced series
- TKP35 series
- TKK series
- EasyTrax® series



## Divider systems

The divider system is mounted on every 2<sup>nd</sup> chain link as a standard.

As a standard, dividers or the complete divider system (dividers with height separations) are movable in the cross section (**version A**).

For applications with lateral acceleration and lying on the side, divider with arresting cams are available.

The locking cams click into place in the locking grids in the stays (**version B**).

### Divider system TSO without height separation

Vers.	a <sub>T</sub> min [mm]	a <sub>x</sub> min [mm]	a <sub>c</sub> min [mm]	a <sub>x</sub> grid [mm]	n <sub>T</sub> min
A	10	16	12	-	-
B	10	17.5	13.5	2.5	-

Number of dividers for design 020 depending on B<sub>1</sub>

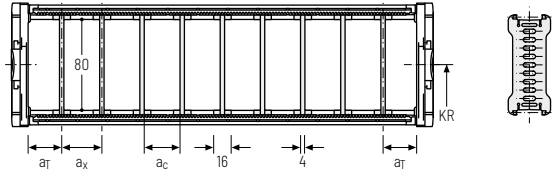

### Divider system TS1 with continuous height separation\*

Vers.	a <sub>T</sub> min [mm]	a <sub>x</sub> min [mm]	a <sub>c</sub> min [mm]	a <sub>x</sub> grid [mm]	n <sub>T</sub> min
A	10	16	12	-	2
B	10	17.5	13.5	2.5	2

\* not for design 020

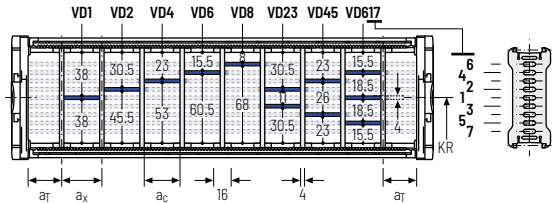

## Order example



·  ·  ·   
 :

Divider system      Version      n<sub>T</sub>      Height separation

Please state the designation of the divider system (**TS0, TS1,...**), the version, and the number of dividers per cross section [n<sub>T</sub>].

When using divider systems with height separation (**TS1**), please additionally state the position (e.g. VD1) viewed from the left driver belt. You are welcome to add a sketch to your order.

Cable carrier

Cable carrier configuration

Configuration guidelines

Materials information

MONO series

QuickTrax® series

UNIFLEX Advanced series

TKP35 series

TKK series

EasyTrax® series

**Divider system TS3** with height separation consisting of plastic partitions

As a standard, the divider **version A** is used for vertical partitioning within the cable carrier. The complete divider system can be moved within the cross section.

**Divider version A**

**End divider**



Vers.	a <sub>T</sub> min [mm]	a <sub>x</sub> min [mm]	a <sub>c</sub> min [mm]	n <sub>T</sub> min
A	8 / 4*	14	10	2

Number of dividers for design D20 depending on B;  
\* For End divider

The dividers are fixed by the partitions, the complete divider system is movable in the cross section.

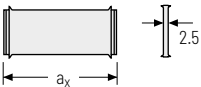
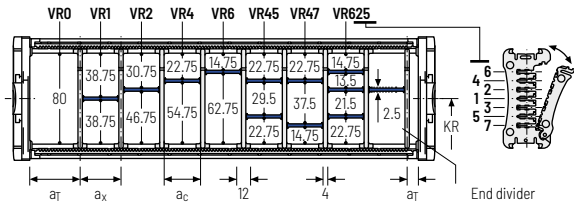

a <sub>x</sub> (center distance of dividers) [mm]																
a <sub>c</sub> (nominal width of inner chamber) [mm]																
14	16	19	23	24	28	29	32	33	34	38	39	43	44	48	49	54
10	12	15	19	20	24	25	28	29	30	34	35	39	40	44	45	50
58	59	64	68	69	74	78	79	80	84	88	89	94	96	99	112	
54	55	60	64	65	70	74	75	76	80	84	85	90	92	95	108	

An additional central support is required when using plastic partitions with a<sub>x</sub> > 49 mm.

**Order example**

🛒

TS3

A

3

K1

34

VR1

:  
:

K4

38

VR3

Divider system      Version      n<sub>T</sub>      Chamber      a<sub>x</sub>      Height separation

Please state the designation of the divider system (**TS0, TS1,...**), version and number of dividers per cross section [n<sub>T</sub>]. In addition, please also enter the chambers [K] from left to right, as well as the assembly distances [a<sub>T</sub>/a<sub>x</sub>] (as seen from the driver).

If using divider systems with height separation (**TS1, TS3**) please also state the positions [e.g. VD23] viewed from the left driver belt. You are welcome to add a sketch to your order.

UNIFLEX Advanced series	Cable carrier
TKR35 series	Cable carrier configuration
TKK series	Configuration guidelines
EasyTrax® series	Materials information
	MONO series

EasyTrax®  
seriesTKK  
seriesTKP35  
seriesUNIFLEX  
Advanced  
seriesQuickTrax®  
seriesMONO  
seriesMaterials  
informationConfiguration  
guidelinesCable carrier  
configuration

Cable carrier

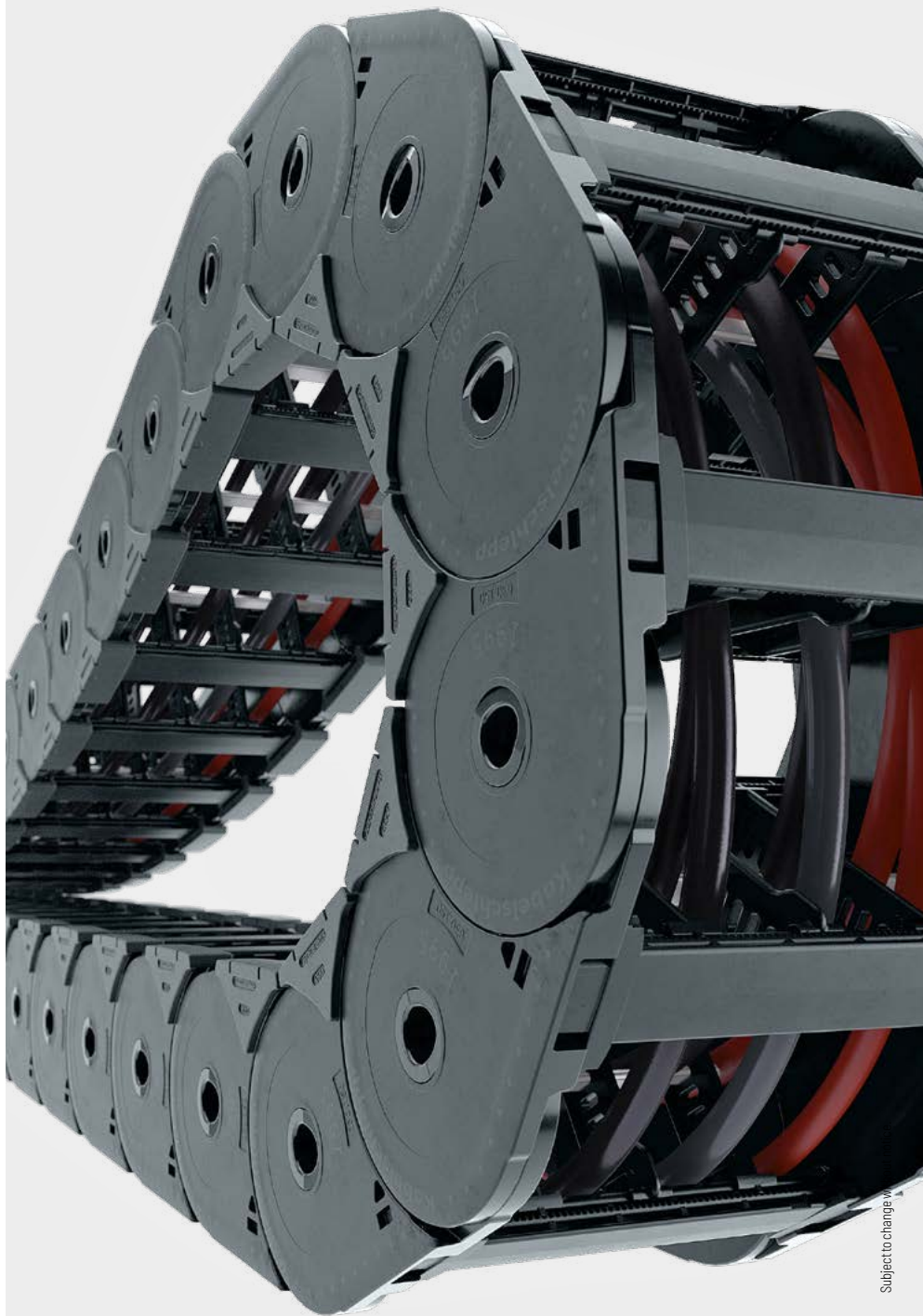

## Universal end connectors UMB – plastic (standard)

The universal mounting brackets (UMB) are made from plastic and can be mounted **from above, from below or on the face side**.

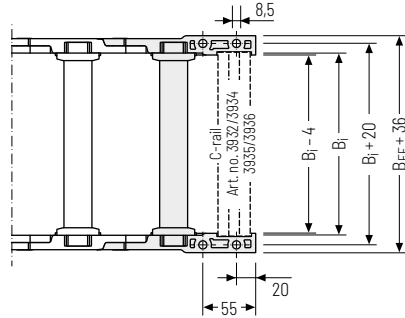
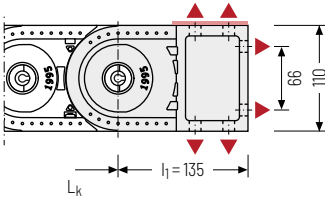

▲ Assembly options

 Recommended tightening torque:  
27 Nm for screws M8

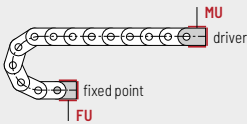

**Connection point**  
F - fixed point  
M - driver

**Connection type**  
U - Universal mounting bracket

### Order example

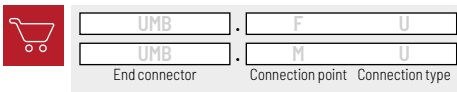

 We recommend the use of strain reliefs at the driver and fixed point. See from p. 904.

Cable carrier

Cable carrier configuration

Configuration guidelines

Materials information

MONO series

QuickTrax® series

UNIFLEX Advanced series

TKP35 series

TKK series

EasyTrax® series

### Additional product information online



Installation instructions, etc.:  
Additional info via your smartphone or check online at [tsubaki-kabelschlepp.com/downloads](http://tsubaki-kabelschlepp.com/downloads)



Configure your cable carrier here:  
[online-engineer.de](http://online-engineer.de)

# UNIFLEX *Advanced* series

Light and quiet all-rounder



Trademarks are legally protected for the TSUBAKI KABELSCHLEPP GmbH  
as a national or international registration in the following countries:  
[tsubaki-kabelschlepp.com/trademarks](http://tsubaki-kabelschlepp.com/trademarks)

Subject to change without notice.

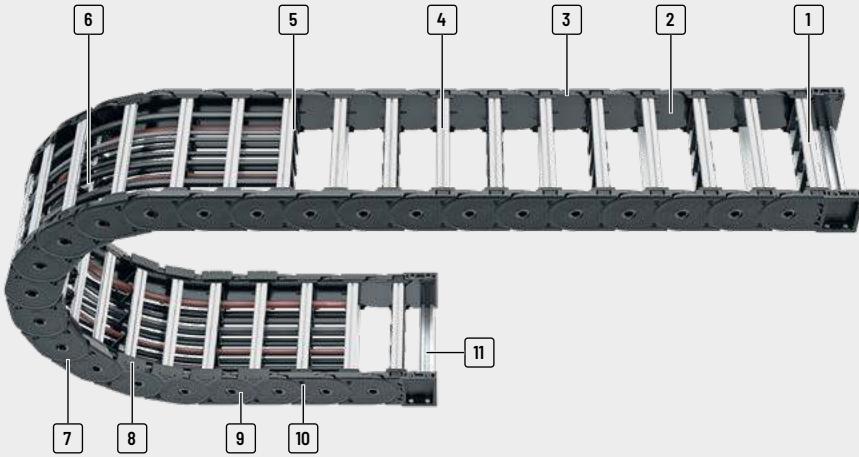

- 1 Aluminum stays available in **1 mm width sections**
- 2 Favourable ratio of inner to outer width
- 3 Chain link plates made of at least 35 % pure regrgranulate
- 4 Quick and easy opening to the inside or outside for cable laying
- 5 Fixable dividers
- 6 Many separation options for the cables
- 7 Robust double-stroke system for long unsupported lengths
- 8 Replaceable glide shoes
- 9 Very quiet through integrated noise damping
- 10 Lateral wear surfaces
- 11 C-rail for strain relief elements

## Features

- » Four designs: closed, and openable to the inner or outer side or to both sides
- » Good ratio of inner to outer width
- » Easy assembly and fast cable laying
- » UMB connectors made of sturdy plastic (strengths comparable to aluminium)
- » Low-wear, cable-friendly design with smooth surface
- » Polygon-optimized bending radii for smooth and low-wear chain running

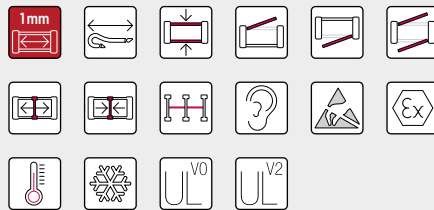

Replaceable glide shoes - optionally with automatic wear monitoring



UMB connectors made of sturdy plastic (strengths comparable to aluminium)

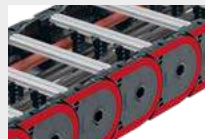

Lateral wear surfaces - for long service life for applications where the carrier is rotated through 90°



Rear grips at stopper for better force transmission and higher strengths

PROTUM®  
series

K  
series

UNIFLEX  
Advanced  
series

M  
series

XL  
series

QUANTUM®  
series

TKR  
series

TKA  
series

UAT  
series

Type	Opening variant	Stay variant	$h_i$ [mm]	$h_G$ [mm]	$B_i$ [mm]	$B_k$ [mm]	$B_i$ - grid [mm]	t [mm]	KR [mm]	Additional load $\leq$ [kg/m]	Cable- $d_{max}$ [mm]
<b>UA1995</b>											
		RSH 020	80	110	66 - 600	96 - 630	1	99.5	150 - 500	50	64
		RSH 030	80	110	66 - 600	96 - 630	1	99.5	150 - 500	50	64
		RSH 040	80	110	66 - 600	96 - 630	1	99.5	150 - 500	50	64
		RSH 070	80	110	66 - 600	96 - 630	1	99.5	150 - 500	50	64

PROTUM®  
seriesK  
seriesUNIFLEX  
Advanced  
seriesM  
seriesXL  
seriesQUANTUM®  
seriesTKR  
seriesTKA  
seriesUAT  
series

Unsupported arrangement			Gliding arrangement			Inner Distribution				Movement			Page	
Travel length ≤ [m]	$v_{max} \leq [m/s]$	$a_{max} \leq [m/s^2]$	Travel length ≤ [m]	$v_{max} \leq [m/s]$	$a_{max} \leq [m/s^2]$	TS0	TS1	TS2	TS3	vertical hanging or standing	lying on the side	rotating arrangement		
										•	•	•	•	342
9	10	25	200	8	20	•	-	-	•	•	•	•	•	342
9	10	25	200	8	20	•	•	-	•	•	•	•	•	343
9	10	25	200	8	20	•	•	-	•	•	•	•	•	344
9	10	25	200	8	200	•	•	-	•	•	•	•	•	345

PROTUM® series

K series

UNIFLEX Advanced series

M series

XL series

QUANTUM® series

TKR series

TKA series

UAT series



# UA1995



**Pitch**  
99.5 mm



**Inner height**  
80 mm



**Inner widths**  
66 – 600 mm



**Bending radii**  
150 – 500 mm

## Stay variants

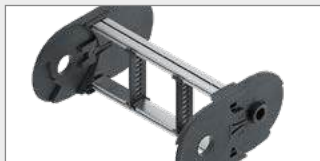

**Design RSH 020** ..... page **342**

### Closed frame

- » Aluminum profile bars for light to medium loads.  
Assembly without screws.
- » **Outside/inside:** not openable.

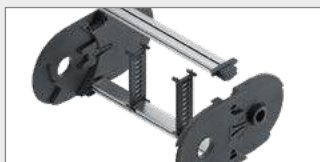

**Design RSH 030** ..... page **343**

### Frame with outside detachable stays

- » Aluminum profile bars for light to medium loads.  
Assembly without screws.
- » **Outside:** release by rotating 90°.



**Design RSH 040** ..... page **344**

### Frame with inside detachable stays

- » Aluminum profile bars for light to medium loads.  
Assembly without screws.
- » **Inside:** release by rotating 90°.



**Design RSH 070** ..... page **345**

### Frame with outside and inside detachable stays

- » Aluminum profile bars for light to medium loads.  
Assembly without screws.
- » **Outside/inside:** release by rotating 90°.

Unsupported arrangement

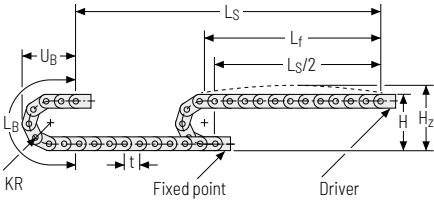

KR [mm]	H [mm]	H <sub>2</sub> [mm]	L <sub>B</sub> [mm]	U <sub>B</sub> [mm]
150	410	440	680	250
210	530	560	860	310
250	610	640	990	350
300	710	740	1150	400
350	810	840	1300	450
400	910	940	1460	500
500	1110	1140	1770	600

**Load diagram for unsupported length** depending on the additional load.

Sagging of the cable carrier is technically permitted for extended travel lengths, depending on the specific application.

Intrinsic cable carrier weight  $q_k = 3.85 \text{ kg/m}$  with  $B_i$  196 mm. For other inner widths, the maximum additional load changes.

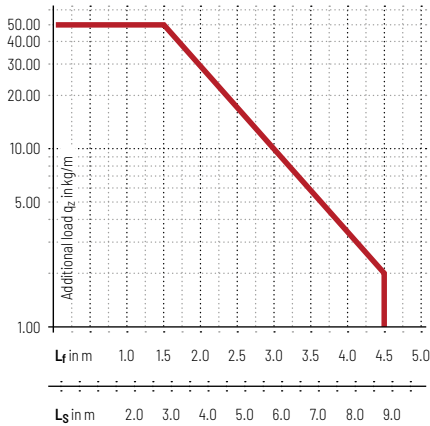

- Speed**  
up to 10 m/s
- Acceleration**  
up to 25 m/s<sup>2</sup>
- Travel length**  
up to 9 m
- Additional load**  
up to 50 kg/m

Gliding arrangement | GO module with chain links optimized for gliding\*

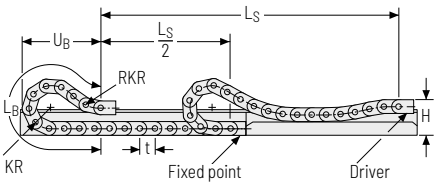

KR [mm]	H [mm]	GO-Modul RKR [mm]	L <sub>B</sub> [mm]	U <sub>B</sub> [mm]
150	330	400	1805	890
210	330	400	2180	1010
250	330	400	2390	1070
300	330	400	2690	1160
350	330	400	3090	1310
400	330	400	3490	1450
500	330	400	4280	1740

- Speed**  
up to 8 m/s
- Acceleration**  
up to 20 m/s<sup>2</sup>
- Travel length**  
up to 200 m
- Additional load**  
up to 50 kg/m

The gliding cable carrier must be guided in a channel. See p. 844.

The GO module mounted on the driver is a defined sequence of 5 adapted KR/RKR link plates.

Glide shoes must be used for gliding applications.

\* only design 070

PROTUM® series
K series
UNIFLEX Advanced series
M series
XL series
QUANTUM® series
TKR series
TKA series
UAT series

## Stay variant RSH 020 – closed frame

- » Aluminum profile bars for light to medium loads. Assembly without screws.
- » Available customized in **1 mm grid**.
- » **Outside/inside:** not openable.



Stay arrangement on each chain link (**VS: fully-stayed**)



**1 mm** B<sub>i</sub> 66 – 600 mm in **1 mm** width sections

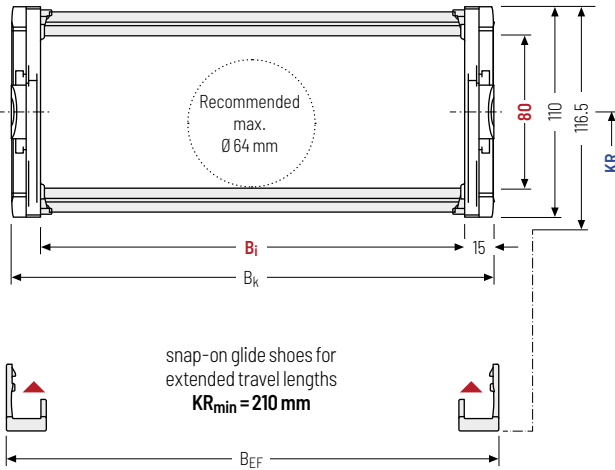

The maximum cable diameter strongly depends on the bending radius and the desired cable type. Please contact us.

### Calculating the cable carrier length

**Cable carrier length L<sub>k</sub>**

$$L_k \approx \frac{L_S}{2} + L_B$$

Cable carrier length L<sub>k</sub> rounded to pitch t

h <sub>i</sub> [mm]	h <sub>G</sub> [mm]	h <sub>G</sub> ' [mm]	B <sub>i</sub> [mm]*	B <sub>k</sub> [mm]	B <sub>EF</sub> [mm]	KR [mm]					q <sub>k</sub> [kg/m]		
80	110	116.5	<b>66 – 600</b>	B <sub>i</sub> + 30	B <sub>i</sub> + 36	150	210	250	300	350	400	500	4,168 – 4,173

\* in 1 mm width sections

### Order example

UA1995
·
150
·
RSH 020
·
210
·
3582
·
VS

Type · B<sub>i</sub> [mm] · Stay variant · KR [mm] · L<sub>k</sub> [mm] · Stay arrangement

### Stay variant RSH 030 – with outside detachable stays

- » Aluminum profile bars for light to medium loads. Assembly without screws.
- » Available customized in **1 mm grid**.
- » **Outside:** release by rotating 90°.



 Stay arrangement on each chain link (**VS: fully-stayed**)

 **1mm** B<sub>i</sub> 66 – 600 mm in 1 mm width sections

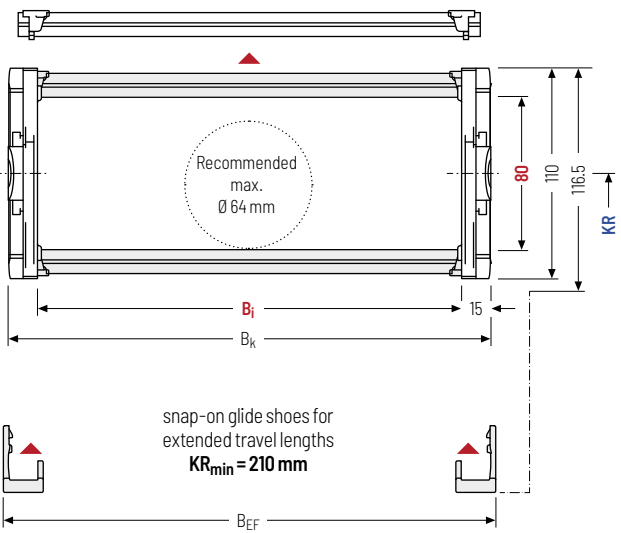

 The maximum cable diameter strongly depends on the bending radius and the desired cable type. Please contact us.

#### Calculating the cable carrier length

**Cable carrier length L<sub>k</sub>**

$$L_k \approx \frac{L_S}{2} + L_B$$

Cable carrier length L<sub>k</sub> rounded to pitch t

h <sub>i</sub> [mm]	h <sub>G</sub> [mm]	h <sub>G</sub> ' [mm]	B <sub>i</sub> [mm]*	B <sub>k</sub> [mm]	B <sub>EF</sub> [mm]	KR [mm]					q <sub>k</sub> [kg/m]		
80	110	116.5	66 - 600	B <sub>i</sub> + 30	B <sub>i</sub> + 36	150	210	250	300	350	400	500	4,192 - 4,197

\* in 1 mm width sections

#### Order example

 UA1995 · 150 · RSH 030 · 210 · 3582 · VS

Type · B<sub>i</sub> [mm] · Stay variant · KR [mm] · L<sub>k</sub> [mm] · Stay arrangement

## Stay variant RSH 040 – with inside detachable stays

- » Aluminum profile bars for light to medium loads.  
Assembly without screws.
- » Available customized in **1 mm grid**.
- » **Inside:** release by rotating 90°.



Stay arrangement on each chain link (**VS: fully-stayed**)



**1 mm** B<sub>i</sub>: 66 – 600 mm  
in 1 mm width sections

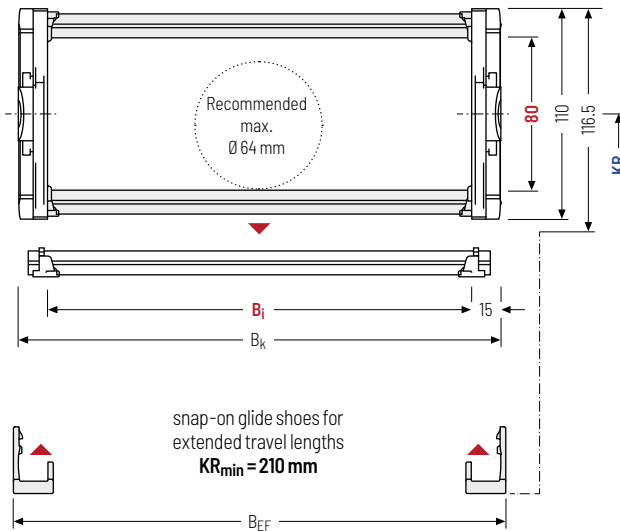

The maximum cable diameter strongly depends on the bending radius and the desired cable type. Please contact us.



Design RSH 040 is not suitable for a gliding arrangements without the use of gliding shoes.

### Calculating the cable carrier length

**Cable carrier length L<sub>k</sub>**

$$L_k \approx \frac{L_S}{2} + L_B$$

Cable carrier length L<sub>k</sub>  
rounded to pitch t

h <sub>i</sub> [mm]	h <sub>G</sub> [mm]	h <sub>G</sub> ' [mm]	B <sub>i</sub> [mm]*	B <sub>k</sub> [mm]	B <sub>EF</sub> [mm]	KR [mm]					q <sub>k</sub> [kg/m]		
80	110	116.5	66 – 600	B <sub>i</sub> + 30	B <sub>i</sub> + 36	150	210	250	300	350	400	500	4,192 – 4,197

\* in 1 mm width sections

### Order example



UA1995  
Type

150  
B<sub>i</sub> [mm]

RSH 040  
Stay variant

210  
KR [mm]

3582  
L<sub>k</sub> [mm]

VS  
Stay arrangement

### Stay variant RSH 070 – with outside and inside detachable stays

- » Aluminum profile bars for light to medium loads. Assembly without screws.
- » Available customized in **1 mm grid**.
- » **Outside/Inside:** release by rotating 90°.



Stay arrangement on each chain link (**VS: fully-stayed**)

**1mm** B<sub>i</sub> 66 – 600 mm in 1 mm width sections

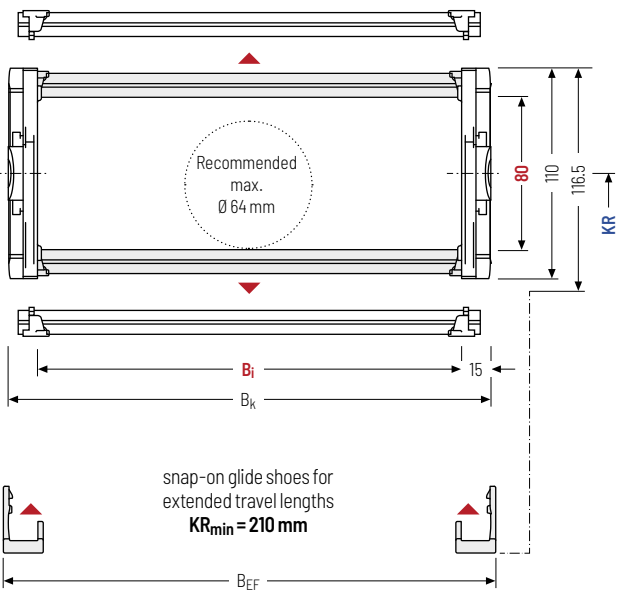

The maximum cable diameter strongly depends on the bending radius and the desired cable type. Please contact us.

Design RSH 070 is not suitable for a gliding arrangements without the use of gliding shoes.

#### Calculating the cable carrier length

**Cable carrier length L<sub>k</sub>**

$$L_k \approx \frac{L_S}{2} + L_B$$

Cable carrier length L<sub>k</sub> rounded to pitch t

h <sub>i</sub> [mm]	h <sub>G</sub> [mm]	h <sub>G</sub> ' [mm]	B <sub>i</sub> [mm]*	B <sub>k</sub> [mm]	B <sub>EF</sub> [mm]	KR [mm]					q <sub>k</sub> [kg/m]		
80	110	116.5	66 - 600	B <sub>i</sub> + 30	B <sub>i</sub> + 36	150	210	250	300	350	400	500	4,211 - 4,216

\* in 1 mm width sections

#### Order example

UA1995 · 150 · RSH 070 · 210 · 3582 · VS

Type · B<sub>i</sub> [mm] · Stay variant · KR [mm] · L<sub>k</sub> [mm] · Stay arrangement

- PROTUM® series
- K series
- UNIFLEX Advanced series
- M series
- XL series
- QUANTUM® series
- TKR series
- TKA series
- UAT series

### Divider systems

The divider system is mounted on every 2<sup>nd</sup> chain link as a standard.

For applications with lateral acceleration and lying on the side, the dividers can be attached by a fixing profile, available as an accessory (**version B**). The fixing profile must be installed at the factory.

As a standard, dividers or the complete divider system (dividers with height separations) are movable in the cross section (**version A**).

PROTUM® series

K series

UNIFLEX Advanced series

### Divider system TSO without height separation

Vers.	a <sub>T</sub> min [mm]	a <sub>X</sub> min [mm]	a <sub>C</sub> min [mm]	a <sub>X</sub> grid [mm]	η <sub>T</sub> min
A	10	16	12	-	-
B	10	17.5	13.5	2.5	-

Number of dividers for design 020 depending on B;

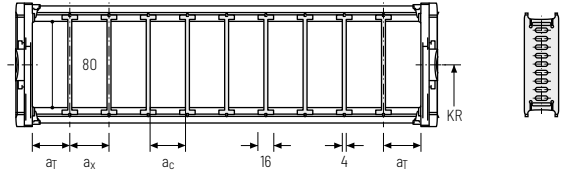

### Divider system TS1 with continuous height separation\*

Vers.	a <sub>T</sub> min [mm]	a <sub>X</sub> min [mm]	a <sub>C</sub> min [mm]	a <sub>X</sub> grid [mm]	η <sub>T</sub> min
A	10	16	12	-	2
B	10	17.5	13.5	2.5	2

\* not for design 020

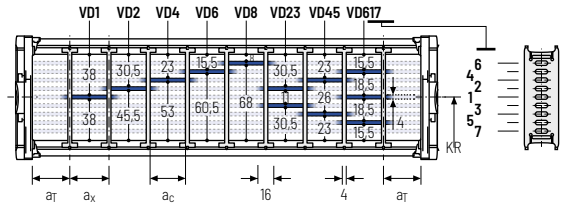

M series

XL series

### Order example

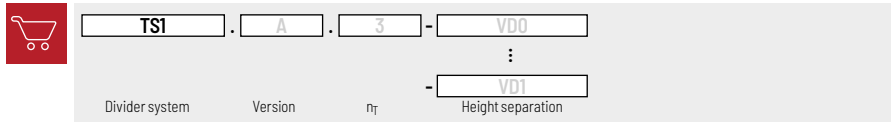

Please state the designation of the divider system (TS0, TS1,...), the version, and the number of dividers per cross section [η<sub>T</sub>].

When using divider systems with height separation (TS1), please additionally state the position (e.g. VD1) viewed from the left driver belt. You are welcome to add a sketch to your order.

QUANTUM® series

TKR series

TKA series

UAT series

**Divider system TS3** with height separation consisting of plastic partitions

As a standard, the divider **version A** is used for vertical partitioning within the cable carrier. The complete divider system can be moved within the cross section.

Divider version A

End divider



Vers.	a <sub>T</sub> min [mm]	a <sub>x</sub> min [mm]	a <sub>c</sub> min [mm]	n <sub>T</sub> min
A	8/4*	14	10	2

Number of dividers for design D20 depending on B;  
\* For End divider

The dividers are fixed by the partitions, the complete divider system is movable in the cross section.

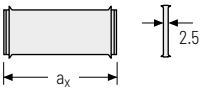
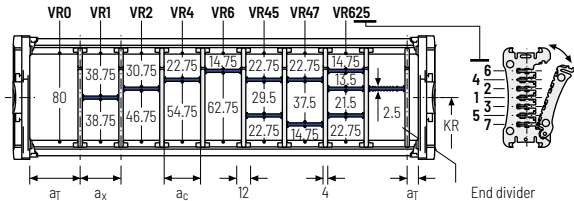

a <sub>x</sub> (center distance of dividers) [mm]																
a <sub>c</sub> (nominal width of inner chamber) [mm]																
14	16	19	23	24	28	29	32	33	34	38	39	43	44	48	49	54
10	12	15	19	20	24	25	28	29	30	34	35	39	40	44	45	50
58	59	64	68	69	74	78	79	80	84	88	89	94	96	99	112	
54	55	60	64	65	70	74	75	76	80	84	85	90	92	95	108	

An additional central support is required when using plastic partitions with a<sub>x</sub> > 49 mm.

**Order example**

TS3 . 
 A . 
 3 . 
 K1 . 
 34 - 
 VR1  
 ⋮ ⋮ ⋮  
K4 . 
 38 - 
 VR3

Divider system      Version      n<sub>T</sub>      Chamber      a<sub>x</sub>      Height separation

Please state the designation of the divider system (**TS0, TS1,...**), version and number of dividers per cross section [n<sub>T</sub>]. In addition, please also enter the chambers [K] from left to right, as well as the assembly distances [a<sub>T</sub>/a<sub>x</sub>] (as seen from the driver).

If using divider systems with height separation (**TS1, TS3**) please also state the positions [e.g. VD23] viewed from the left driver belt. You are welcome to add a sketch to your order.

- PROTUM® series
- K series
- UNIFLEX Advanced series
- M series
- XL series
- QUANTUM® series
- TKR series
- TKA series
- UAT series



PROTUM®  
series

K  
series

UNIFLEX  
Advanced  
series

M  
series

XL  
series

QUANTUM®  
series

TKR  
series

TKA  
series

UAT  
series



## Universal end connectors UMB – plastic (standard)

The universal mounting brackets (UMB) are made from plastic and can be mounted **from above, from below or on the face side**.

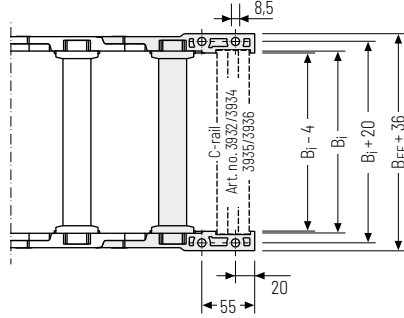
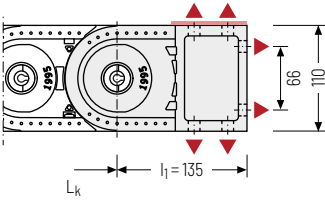

▲ Assembly options

 Recommended tightening torque:  
27 Nm for screws M8

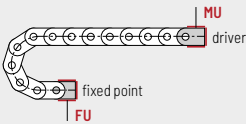

**Connection point**  
**F** - fixed point  
**M** - driver

**Connection type**  
**U** - Universal mounting bracket

### Order example

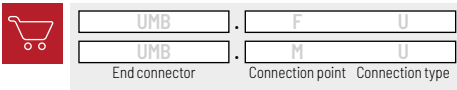

 We recommend the use of strain reliefs at the driver and fixed point. See from p. 904.

PROTUM® series

K series

UNIFLEX Advanced series

M series

XL series

QUANTUM® series

TKR series

TKA series

UAT series

### Additional product information online



Installation instructions, etc.:  
 Additional info via your smartphone or check online at [tsubaki-kabelschlepp.com/downloads](http://tsubaki-kabelschlepp.com/downloads)



Configure your cable carrier here:  
[online-engineer.de](http://online-engineer.de)